



HAMILTON-S1

Operator's Manual

REF 159005NK, 159005MA, 159007

Software version 2.8.x
624302/07 | 2018-08-31

CE 0197

HAMILTON
MEDICAL
Intelligent Ventilation since 1983

Operator's Manual

HAMILTON-S1

2018-08-31

624302/07

© 2018 Hamilton Medical AG. All rights reserved. Printed in Switzerland.

No part of this publication may be reproduced, stored in a database or retrieval system, or transmitted in any form or by any means, electronic, mechanical, or by photocopying, recording, or otherwise, without prior written permission of Hamilton Medical AG.

This document may be revised, replaced, or made obsolete by other documents by Hamilton Medical AG at any time and without notice. Ensure that you have the most current applicable version of this document; if in doubt, contact the technical support department of Hamilton Medical AG, Switzerland. While the information set forth herein is believed to be accurate, it is not a substitute for the exercise of professional judgment.

Nothing in this document shall limit or restrict in any way Hamilton Medical AG's right to revise or otherwise change or modify the equipment (including its software) described herein, without notice. In the absence of an express, written agreement to the contrary, Hamilton Medical AG has no obligation to furnish any such revisions, changes, or modifications to the owner or user of the equipment (including software) described herein.

The equipment must be operated, serviced, or upgraded only by trained professionals. Hamilton Medical AG's sole responsibility with respect to the equipment and its use is as stated in the limited warranty provided in the device *Operator's Manual*.

Hamilton Medical AG shall not be liable for any loss, cost, expense, inconvenience, or damage that may arise out of misuse of the product, or if non-Hamilton Medical AG parts were used when replacing parts, or if serial numbers were amended, deleted, or removed.

If returning parts to Hamilton Medical AG, be sure to use the standard Hamilton Medical returned goods authorization (RGA) procedure. Disposal of parts shall follow all local, state, and federal regulation with respect to environmental protection.

Hamilton Medical AG will make available, on request, circuit diagrams, component parts lists, descriptions, calibration instructions, or other information that will assist appropriately trained personnel to repair those parts of the equipment designated by Hamilton Medical AG to be repairable.

For all proprietary as well as third-party trademarks used by Hamilton Medical AG, see www.hamilton-medical.com/trademarks. Product and/or company names marked with a [§] symbol may be the trademarks and/or registered trademarks of their respective owners, including but not limited to Aerogen[§], Nihon Kohden[§], Masimo[§], Masimo SET[§], Masimo rainbow SET[§], Respironics[§].

Manufacturer

Hamilton Medical AG
Via Crusch 8, CH-7402 Bonaduz,
Switzerland
Phone: (+41) 58 610 10 20
Fax: (+41) 58 610 00 20
info@hamilton-medical.com
www.hamilton-medical.com

Distributor in USA

Hamilton Medical, Inc.
4990 Energy Way, P.O. Box 30008
Reno, NV 89520
Phone: (775) 858-3200
Toll-free: (800) 426-6331
Fax: (775) 856-5621
marketing@hamilton-medical.net

Table of Contents

	Preface	19
Chapter 1	Safety information	21
1.1	Overview.....	22
1.2	Electromagnetic susceptibility.....	22
1.3	Fire and other hazards.....	23
1.4	General operation and setup.....	23
1.4.1	General operation and setup.....	23
1.4.2	Electrical: power and batteries.....	24
1.4.3	Gas supply	25
1.4.4	CompactFlash port.....	26
1.5	Setting up for ventilation.....	26
1.5.1	Patient breathing circuits, components, and accessories	26
1.5.2	Preoperational check and tests	27
1.5.3	Humidifier.....	28
1.5.4	IntelliCuff.....	28
1.5.5	CO2 sensor setup and operation	29
1.5.6	Nebulization.....	30
1.6	Ventilating the patient	31
1.6.1	Specifying patient settings.....	31
1.6.2	Neonatal ventilation	31
1.6.3	Apnea backup.....	32
1.6.4	TRC settings.....	32
1.6.5	Noninvasive ventilation.....	32
1.6.6	P/V Tool Pro	33
1.6.7	Using high flow oxygen therapy.....	33
1.7	Monitoring and alarms.....	33
1.8	Using the trolley.....	34

1.9	Maintenance	34
1.9.1	General maintenance, cleaning, and disinfection	34
1.9.2	Preventive maintenance	36
1.9.3	O2 sensor	36
1.10	Service and testing	37
Chapter 2	System overview	39
2.1	Overview	40
2.1.1	Standard features and options	40
2.2	Physical descriptions	43
2.2.1	About the ventilator	43
2.2.2	About the main display	48
2.2.3	About the patient breathing circuits	50
2.2.4	About the trolley and mounting variations	55
2.2.5	Setting up the monitor	56
2.3	Navigating the windows and controls	57
2.3.1	Accessing windows	57
2.3.2	Adjusting controls	58
2.3.3	Selecting list items	58
Chapter 3	Preparing the ventilator	59
3.1	Overview	60
3.2	Connecting to a power source	60
3.2.1	Using battery power	60
3.3	Connecting the oxygen supply	61
3.3.1	Working with heliox as a gas source	61
3.3.2	Selecting the gas source type	62
3.4	Setting up the patient breathing circuit	62
3.4.1	Breathing circuit connections on the ventilator	63
3.4.2	Working with the expiratory valve set	63
3.4.3	Selecting the breathing circuit components	64

3.4.4	Assembling the patient breathing circuit	65
3.4.5	Positioning the breathing circuit	65
3.5	Setting up esophageal/transpulmonary pressure monitoring	66
3.6	Turning the ventilator on and off	66
Chapter 4	Setting up external devices and sensors.....	67
4.1	Overview.....	68
4.2	Installing a module.....	68
4.3	Setting up a humidifier.....	68
4.4	Setting up the IntelliCuff cuff pressure controller.....	69
4.4.1	About the IntelliCuff tubing	70
4.4.2	Setting up IntelliCuff.....	70
4.5	Setting up CO2 monitoring.....	70
4.5.1	Mainstream CO2 measurement.....	71
4.5.2	Sidestream CO2 measurement	73
4.6	Setting up SpO2 monitoring.....	74
4.7	Enabling sensors	74
4.8	Setting up nebulization	75
4.8.1	Setting up a pneumatic nebulizer	75
4.8.2	Setting up an Aerogen nebulizer	76
4.9	Connecting to an external patient monitor or other device.....	76
Chapter 5	Specifying ventilation settings	77
5.1	Process overview	78
5.2	Selecting the patient group	78
5.2.1	About system defaults: pre-configured settings.....	79
5.3	Entering patient data	79
5.4	Performing the preoperational check, tests, and calibrations	80
5.4.1	Performing the preoperational check.....	81
5.4.2	Performing the breathing circuit tightness test	82
5.4.3	Calibrating the adult/pediatric flow sensor	83

5.4.4	Calibrating the O2 sensor.....	84
5.4.5	Performing a zero calibration on the CO2 sensor/adapter.....	85
5.4.6	Testing the alarms.....	86
5.5	Selecting the ventilation mode	88
5.5.1	Reviewing and adjusting ventilation settings.....	90
5.5.2	About the trigger types	90
5.5.3	About apnea backup ventilation.....	93
5.5.4	About tube resistance compensation (TRC)	94
5.6	Setting alarm limits	96
5.7	Starting ventilation	98
5.8	Stopping ventilation	98
5.9	About the control parameters	98
Chapter 6	Specifying neonatal settings	105
6.1	Setting up for neonatal ventilation	106
6.1.1	Setting the patient group and weight.....	106
6.1.2	Setting up the patient breathing circuit	107
6.2	Performing the preoperational check, tests, and calibrations	109
6.2.1	Calibrating the neonatal flow sensor	110
6.3	Selecting the ventilation mode	111
6.4	Setting the patient weight for ventilation	111
6.5	Alarms for neonatal ventilation	112
6.6	O2 enrichment for neonates	112
6.7	Specifying volume limitation for neonates	112
Chapter 7	Ventilation modes	113
7.1	Overview.....	114
7.1.1	Breath types and timing options.....	114
7.1.2	Ventilation modes.....	114
7.1.3	Ventilation controls and settings	116

7.2	Volume-controlled modes, flow control.....	118
7.2.1	(S)CMV mode	118
7.2.2	SIMV mode.....	119
7.3	Volume-controlled modes, flow cycled.....	120
7.3.1	Volume Support (VS).....	120
7.4	Volume-targeted modes, adaptive pressure control.....	122
7.4.1	APVcmv mode	122
7.4.2	APVsimv mode.....	124
7.5	Pressure-controlled modes	126
7.5.1	P-CMV mode	126
7.5.2	P-SIMV mode.....	127
7.5.3	DuoPAP mode.....	128
7.5.4	APRV mode.....	129
7.5.5	SPONT mode.....	130
7.6	Intelligent Ventilation.....	131
7.6.1	ASV mode.....	131
7.6.2	INTELLiVENT-ASV mode	133
7.7	Noninvasive modes	134
7.7.1	NIV mode.....	134
7.7.2	NIV-ST mode.....	135
7.7.3	nCPAP-PS mode.....	136
7.7.4	High flow oxygen therapy	137
7.8	Ambient state	138
7.9	Working with noninvasive modes.....	138
7.9.1	Required conditions for use.....	138
7.9.2	Contraindications.....	139
7.9.3	Potential adverse reactions.....	139
7.9.4	Control settings in noninvasive ventilation.....	139
7.9.5	Alarms in noninvasive ventilation.....	140

7.9.6	Monitored parameters in noninvasive ventilation	140
7.9.7	Additional notes about using noninvasive ventilation.....	141
7.10	Working with ASV	141
7.10.1	Clinical workflow with ASV	142
7.10.2	Maintaining adequate ventilation	143
7.10.3	Reviewing alarm settings.....	144
7.10.4	Monitoring ASV	144
7.10.5	Weaning.....	145
7.10.6	Functional overview	146
Chapter 8	Monitoring ventilation	153
8.1	Overview.....	154
8.2	Viewing numeric patient data	154
8.2.1	About the main monitoring parameters (MMP)	154
8.2.2	About the secondary monitoring parameters (SMPs)	155
8.2.3	Viewing patient data in the Monitoring window	156
8.3	Viewing graphical patient data.....	156
8.3.1	Selecting a display layout	157
8.3.2	Selecting display options	158
8.3.3	Working with waveforms.....	159
8.3.4	Working with Trend graphs.....	163
8.3.5	Working with loops.....	164
8.4	Working with Intelligent panels.....	165
8.4.1	Dynamic Lung panel: real-time ventilation status	165
8.4.2	Vent Status panel: real-time ventilator dependence status	168
8.4.3	ASV Graph panel: real-time patient condition and targets	170
8.4.4	ASV Monitoring panel: real-time values.....	171
8.5	Monitoring transpulmonary/esophageal pressure	171
8.6	About the monitored parameters	172

8.7	Viewing patient ventilation time.....	182
8.8	Viewing device-specific information	182
Chapter 9	Responding to alarms	183
9.1	Overview.....	184
9.1.1	Alarm limit indicators	186
9.1.2	Responding to an alarm	186
9.1.3	Temporarily silencing an alarm	187
9.2	About the alarm buffer	187
9.3	Adjusting alarm loudness (volume)	189
9.4	Troubleshooting alarms.....	189
9.5	Working with a distributed alarm system (DAS)	205
9.5.1	Enabling global AUDIO OFF.....	206
9.5.2	About DAS-related alarms.....	206
Chapter 10	Ventilation settings and functions	209
10.1	Overview.....	210
10.2	Accessing settings during ventilation	210
10.2.1	Accessing patient data during ventilation	210
10.2.2	Accessing settings during ventilation	211
10.3	Entering/exiting Standby	212
10.4	Oxygen enrichment.....	213
10.4.1	Adjusting the oxygenation level for O2 enrichment	213
10.4.2	Suctioning maneuver	214
10.5	Manual breath	215
10.6	Inspiratory and expiratory hold	215
10.6.1	Inspiratory hold	215
10.6.2	Expiratory hold.....	216
10.7	Working with a nebulizer	216
10.7.1	Specifying duration and synchronization settings.....	216
10.7.2	Working with a pneumatic nebulizer.....	217

10.7.3	Working with an Aerogen nebulizer.....	218
10.8	Locking and unlocking the touch screen.....	218
10.9	Capturing a screenshot.....	219
10.10	About the Event log.....	219
10.11	Setting display options.....	220
10.11.1	Setting date and time.....	220
10.11.2	Day and night display brightness.....	221
Chapter 11	Working with P/V Tool.....	223
11.1	Overview.....	224
11.1.1	Conditions for use.....	224
11.1.2	Indications for use.....	225
11.1.3	Contraindications for use.....	225
11.2	Using the P/V Tool.....	225
11.3	Opening the P/V Tool.....	226
11.4	Adjusting the control settings.....	227
11.5	Performing a P/V Tool maneuver.....	228
11.5.1	Viewing data.....	229
11.5.2	Choosing the data to display.....	229
11.6	Analyzing the data.....	232
11.7	Using reference curves.....	232
11.8	Performing a recruitment maneuver.....	233
Chapter 12	Working with external devices.....	235
12.1	Working with the HAMILTON-H900 humidifier.....	236
12.1.1	Accessing humidifier controls on the ventilator.....	237
12.1.2	About the humidifier operating modes.....	238
12.1.3	Changing humidity using temperature controls.....	240
12.1.4	Entering Standby.....	241
12.1.5	Turning the humidifier on/off.....	241

12.1.6	About humidifier-related alarms.....	242
12.1.7	About humidifier-related parameters.....	244
12.2	Working with IntelliCuff.....	245
12.2.1	Accessing IntelliCuff controls on the ventilator.....	246
12.2.2	Turning IntelliCuff on and off.....	247
12.2.3	About IntelliCuff modes.....	248
12.2.4	Setting the cuff pressure.....	249
12.2.5	Deflating the cuff.....	250
12.2.6	About IntelliCuff-related alarms.....	250
12.2.7	About IntelliCuff-related parameters.....	252
12.2.8	Last Patient settings with IntelliCuff.....	252
Chapter 13	Maintenance.....	253
13.1	Overview.....	254
13.2	Cleaning, disinfection, and sterilization.....	254
13.2.1	General guidelines for cleaning.....	254
13.2.2	General guidelines for disinfection.....	255
13.3	Preventive maintenance.....	256
13.4	Performing maintenance tasks.....	258
13.4.1	Maintaining the filters.....	258
13.4.2	Replacing the galvanic O2 sensor.....	259
13.4.3	Charging and storing batteries.....	260
13.4.4	Replacing batteries.....	260
13.5	Repacking and shipping.....	261
Chapter 14	Configuration.....	263
14.1	Overview.....	264
14.2	Accessing Configuration mode.....	264
14.3	Configuring general settings.....	264
14.3.1	Selecting the language.....	264
14.3.2	Selecting the breath timing philosophy.....	264

14.3.3	Selecting the units of measure	264
14.3.4	Configuring adjustable alarms.....	265
14.3.5	Setting the minimum alarm loudness (volume)	265
14.3.6	Enabling the Check flow sensor for water alarm.....	265
14.4	Configuring MMPs.....	266
14.5	Configuring Vent Status settings	266
14.6	Configuring communication options	266
14.6.1	Configuring I:E timing	266
14.6.2	Selecting a communication protocol.....	267
14.6.3	Configuring HAMILTON-H900 humidifier communication	267
14.6.4	Configuring distributed alarm system (DAS) communication... ..	267
14.7	Configuring nebulization options	268
14.8	Activating IntelliCuff	268
14.9	Activating SpO2 and CO2 measurement	268
14.10	Defining system default settings.....	268
14.10.1	Exporting or importing default settings	269
14.10.2	Choosing the ASV version	270
14.10.3	Enabling the display of resistance- and compliance-related parameters.....	270
14.11	Configuring software and hardware options	270
14.11.1	Reviewing installed options	270
14.11.2	Adding software options.....	270
14.11.3	Activating hardware options	271
14.12	Copying configuration settings.....	271
Chapter 15	Parts and accessories.....	273
15.1	Overview.....	274
Chapter 16	Specifications.....	281
16.1	Physical characteristics.....	282
16.2	Environmental requirements.....	283

16.3	Pneumatic specifications	284
16.4	Electrical specifications	285
16.5	Control settings	287
16.6	Monitored parameters	292
16.7	Alarms	299
16.8	Configuration	301
16.9	ASV technical data	304
16.10	Ventilator breathing system specifications	306
16.11	Technical performance data	307
16.11.1	Accuracy testing.....	312
16.11.2	Essential performance	312
16.12	Functional description of ventilator system	312
16.12.1	Gas supply and delivery.....	313
16.12.2	Gas monitoring with the flow sensor.....	314
16.12.3	Pneumatic diagram	315
16.13	Symbols used on device labels and packaging	316
16.13.1	Symbols used on the trolley.....	318
16.14	Standards and approvals	318
16.15	Disposal and year of manufacture	319
16.16	Warranty.....	320
	Glossary	323
	Index	331

HAMILTON-S1 Documentation

This guide is part of a documentation suite that includes, among others, the following documents:

Table 1. HAMILTON-S1 documentation suite

Document title	Description
<i>Operator's Manual (this guide)</i>	Provides detailed information about the setup and use of the HAMILTON-S1 ventilator.
<i>INTELLiVENT-ASV Operator's Manual</i>	Provides setup and use information for the INTELLiVENT-ASV ventilation mode.
<i>Pulse Oximetry Instructions for Use</i>	Provides setup and use information for using SpO2 and related sensors with the ventilator.
<i>Volumetric Capnography User Guide</i>	Provides reference information for CO2 capnography.
<i>HAMILTON-H900 Instructions for Use</i>	Provides specifications, and setup and use information for the HAMILTON-H900 humidifier.
<i>IntelliCuff Instructions for Use</i>	Provides specifications, and setup and use information for the IntelliCuff cuff pressure controller.
<i>Aerogen Solo/Pro Instructions for Use</i>	Provides specifications, and setup and use information for the Aerogen Solo and Aerogen Pro nebulizers.
<i>Communication Interface User Guide</i>	Provides an overview of the communication interface, including how to connect the ventilator to external devices for data communication and support for nurse call remote alarms.
<i>Service Manual</i>	Provides information about installing and setting up the medical equipment, as well as additional technical and servicing information for the ventilator.
<i>EMC Declarations Guide</i>	Provides emissions and EMC-related safety and use information.

Be sure to read the documentation before using the device or accessories.

To download the latest version of this manual or other documents, free of charge, visit the MyHamilton website. To register, go to: <https://www.hamilton-medical.com/MyHamilton>

Hamilton Medical offers the Hamilton Medical College, which provides a variety of learning modules free of charge. To register, go to: <http://college.hamilton-medical.com>

Conventions used in this guide

In this manual:

- Button and tab names are shown in a **bold** font.
- The notation *XX > XX* shows the sequence of buttons/tabs to touch to open the associated window.
For example, the text *Open the System > Settings window* means touch the **System** button, then touch the **Settings** tab.
- *Software version*: The software version for the ventilator is displayed in the System > Info window and should match the version on the title page of this manual.
- *Units of measure*: Pressure is indicated in cmH₂O, length in cm, and temperature in degrees Celsius (°C). The unit of measure for length is configurable.
- The graphics shown in this manual may not exactly match what you see in your environment.

Safety messages are displayed as follows:

WARNING

A WARNING alerts the user to the possibility of injury, death, or other serious adverse reactions associated with the use or misuse of the device.

CAUTION

A CAUTION alerts the user to the possibility of a problem with the device associated with its use or misuse, such as device malfunction, device failure, damage to the device, or damage to other property.

NOTICE

A NOTICE emphasizes information of particular importance.

In tables, safety messages are indicated as follows:

 **WARNING!**

 **CAUTION!**

 **NOTICE!**

Intended use

The HAMILTON-S1 ventilator is designed for intensive care ventilation of adult and pediatric patients, and optionally infant and neonatal patients. The device is intended for use in the hospital and institutional environment where health care professionals provide patient care.

The HAMILTON-S1 ventilator is intended for use by properly trained personnel under the direct supervision of a licensed physician.

The HAMILTON-S1 ventilator may be used for transport within a hospital or hospital type facility provided compressed gas is supplied. The device is not to be used in the presence of flammable anesthetic agents or other ignition sources.

The ventilator is not to be used in an environment with magnetic resonance imaging (MRI) equipment.

The device is not intended for transportation outside the hospital or for use in the home environment.

1

Safety information

1.1	Overview.....	22
1.2	Electromagnetic susceptibility.....	22
1.3	Fire and other hazards.....	23
1.4	General operation and setup.....	23
1.5	Setting up for ventilation.....	26
1.6	Ventilating the patient	31
1.7	Monitoring and alarms.....	33
1.8	Using the trolley.....	34
1.9	Maintenance.....	34
1.10	Service and testing	37

1.1 Overview

This chapter provides safety information related to setting up and operating the ventilator and trolley, as well as providing service.

Be sure to review this Operator's Manual before using the ventilator and any accessories.

Be sure to read the Instructions for Use provided with any devices and accessories used with the ventilator before use.

Carefully review all sections of this safety chapter before setting up the ventilator and accessories, and ventilating the patient.

If you have questions about any of the information in this manual, contact your Hamilton Medical representative or technical service personnel.

1.2 Electromagnetic susceptibility

WARNING

- **MR UNSAFE.** Keep away from magnetic resonance imaging (MRI) equipment. The HAMILTON-S1 poses unacceptable risks to the patient, medical staff, or other persons within the MR environment.
- Correct function of the device may be impaired by the operation of high-frequency surgical equipment, microwaves, shortwaves, or strong magnetic fields in close proximity.
- Follow precautions for electrostatic discharge (ESD) and electromagnetic interference (EMI) to and from the ventilator and any connected devices and accessories.

- Use of accessories, transducers, and cables other than those specified or provided by the manufacturer of this equipment can result in increased electromagnetic emissions or decreased electromagnetic immunity of this equipment, and may result in improper operation.
- Portable RF communications equipment, including peripherals such as antenna cables and external antennas, should be placed no closer than 30 cm (12 in) to any part of the HAMILTON-S1 ventilator, including any cables specified by the manufacturer. Otherwise, degradation of the performance of this equipment can occur.
- The emissions characteristics of this equipment make it suitable for use in industrial areas and hospitals (CISPR 11, class A). If it is used in a residential environment (for which CISPR 11, class B is normally required) this equipment might not offer adequate protection to radio-frequency communication services. The user might need to take mitigation measures, such as relocating or reorienting the equipment.

The HAMILTON-S1 complies with the IEC 60601-1-2 EMC (Electromagnetic Compatibility) Collateral Standard.

The ventilator requires special precautions regarding electromagnetic compatibility (EMC). It must be installed and put into service according to the EMC information provided in the ventilator *EMC Declarations* (PN 624896).

Portable and mobile RF communications equipment can affect the ventilator and all medical electrical equipment.

1.3 Fire and other hazards

WARNING

- It is *not* permitted to use any of the equipment with flammable gases or anesthetic agents, or in insufficiently ventilated areas. Danger of fire!
- Do *not* use the ventilator with any equipment or high-pressure gas hoses that are worn or contaminated with oil or grease.
- Highly compressed oxygen together with flammable sources could lead to spontaneous explosions.
- In case of fire, immediately secure the patient's ventilatory needs, turn off the ventilator, and disconnect it from its gas and electrical sources.
- Do *not* use if primary power source cables are damaged.
- The HAMILTON-S1 can be used in an oxygen-enriched environment. To reduce the risk of fire, use only breathing circuits intended for use in oxygen-enriched environments. Do *not* use antistatic or electrically conductive tubing.

1.4 General operation and setup

This section provides the following safety information:

- General operation and setup
- Electrical: power and batteries
- Gas supply
- USB ports

1.4.1 General operation and setup

WARNING

- Modifications to the device and any accessories are *not* permitted.
- An O2 sensor must be installed.
- In case of ventilator failure, the lack of immediate access to appropriate alternative means of ventilation can result in patient death.
- If a fault is detected in the ventilator or its life-support functions are in doubt, disconnect the ventilator from the patient and immediately start ventilation with an alternate device (for example, a resuscitation bag), using PEEP and/or increased oxygen concentration when appropriate. The ventilator *must* be removed from clinical use and serviced by a Hamilton Medical authorized service engineer.
- Use only parts and accessories specified in Chapter 15 and in the product e-catalog, or that are specified as being compatible with this ventilator. Doing so ensures proper ventilation operation, avoids degraded performance, and keeps your warranty in force.
- The use of this equipment is restricted to one patient at a time.
- Only use the ventilator and its components and accessories according to the intended use and as described in the associated *Instructions for Use*.
- Do *not* connect any component or device to the exhaust port of the expiratory valve unless authorized by Hamilton Medical.
- The ventilator must *not* be used in a hyperbaric chamber.

- If there is damage to any part of the ventilator, do *not* use the device. Technical service is required.
- Do *not* simultaneously touch conductive components (for example, the USB port) or conductive parts of the ventilator enclosure and the patient.
- Additional equipment connected to medical electrical equipment must comply with the respective IEC or ISO standards. All configurations must comply with the requirements for medical electrical systems, IEC 60601-1, clause 16.
- Anybody connecting additional equipment to medical electrical equipment configures a medical system and is responsible for ensuring that the system complies with the requirements for medical electrical systems. Local laws take priority over the above-specified requirements.
- Do not block the holes between the HAMILTON-S1's *To patient* and *From patient* ports. These holes are vents for the overpressure and ambient valves.

 **CAUTION**

To prevent possible patient injury and ventilator overheating, do NOT block the cooling fan vents.

NOTICE

- The barometric pressure is only measured and compensated during ventilator installation and setup, and with every service. There is no automatic calibration for barometric compensation.

- Due to the ventilator's base flow, the exhaust gas output is larger than the patient's actual exhaled volume.

1.4.2 Electrical: power and batteries

 **WARNING**

- Ventilation stops if the battery or batteries are discharged and no external power supply is connected.
- To minimize the risk of electrical shock, plug the ventilator power cord into an appropriate grounded power receptacle. It is the hospital's responsibility to ensure that the receptacle is properly grounded (earth).
- The HAMILTON-S1 requires protective earth grounding, because it is a class I device, as classified according to IEC 60601-1.
- Power sockets that can lead to a failure of ventilation *must* have a locking device.
- It is the responsibility of the operator to ensure that the power system of any device connected to the ventilator power outlet complies with the requirements for medical electrical systems as well as local regulations.
- Periodically check or replace the battery.
- Check the battery charge level before ventilating a patient and before unplugging the ventilator for transport or other purposes.
- Connect only the HAMILTON-H900 to the power strip.

⚠ CAUTION

To electrically isolate the ventilator electrical circuits from all poles of the primary power supply simultaneously, disconnect the power plug.

NOTICE

- Set up the ventilator in a location where the primary power supply is accessible.
- Only authorized service personnel may replace the power cable.
- Battery life indications are approximate. The actual battery life depends on ventilator settings, battery age, and level of battery charge. To ensure maximum battery life, maintain a full charge and minimize the number of complete discharges.
- After power has been interrupted, the device stores the last settings, including any specified alarm limits. Upon reconnection with the power supply, the device resumes ventilation with these stored settings.

1.4.3 Gas supply**⚠ CAUTION**

Always check the status of the oxygen and air cylinders or other supply before using the ventilator during transport.

NOTICE

- To prevent damage to the ventilator, connect only clean, dry medical grade oxygen and air.
- When the ventilator is not in use, disconnect all gases.

1.4.3.1 Working with Heliox**⚠ WARNING**

To prevent possible hypoxia or death, connect a heliox gas supply that contains a minimum of 20% oxygen. The ventilator supports the following gas mixtures (HE% / O2%): 78/22, 79/21, and 80/20.

⚠ CAUTION

To prevent heliox from entering the wall gas supply, connect compressed air with a minimum pressure of 2.8 bar.

NOTICE

- When Heliox is in use:
 - The alarm lamp is illuminated in blue (when an alarm is generated, the lamp alternates blue with yellow or red, depending on the alarm priority)
 - O₂ monitoring *cannot* be disabled
- Heliox is disabled when any of the following are selected or active:
 - Nebulization
 - INTELLiVENT-ASV mode
 - Tube resistance compensation (TRC)
- In the System > Gas source window, ensure that the selected gas source type matches the gas source connected to the ventilator. A mismatch can result in inaccurate gas delivery and volume monitoring.
- Calibrate the flow sensor after:
 - Switching between air and heliox connections
 - Significant changes in O₂ concentration during heliox ventilation

1.4.4 CompactFlash port

NOTICE

The CompactFlash port is for data export and program update only (screenshots and log files). A Hamilton Medical CompactFlash card is recommended.

1.5 Setting up for ventilation

This section provides the following safety information:

- Patient breathing circuits, components, and accessories
- Performing preoperational checks and testing
- Humidifier
- IntelliCuff
- CO₂ monitoring setup and operation
- Nebulization
- SpO₂ monitoring setup and operation
See the *Pulse Oximetry Instructions for use*.

1.5.1 Patient breathing circuits, components, and accessories

In addition to the information provided in this section, carefully review the information in Sections 1.3 and 1.4.

WARNING

- **To prevent patient or ventilator contamination, always use a bacteria filter or HMEF between the patient and the inspiratory port. If no bacteria filter is used, the exhaled gas can contaminate the ventilator.**
- Ensure that all of the components of the breathing circuit set, including but *not* limited to flow sensor, humidifier, and other accessories, match the associated intended use for the target patient group.

- Adding attachments or other components/assemblies to a breathing system can change the pressure gradient across the ventilator, which can adversely affect ventilator performance.
- For each new patient, always use a new or reprocessed breathing circuit to avoid cross contamination.
- During ventilation, regularly check the breathing circuit filter for increased resistance and blockage.

NOTICE

- Any bacteria filter, HMEF, or additional accessories in the expiratory limb may substantially increase flow resistance and impair ventilation.
- When adding components to the Hamilton Medical breathing circuit configurations, do *not* exceed the inspiratory and expiratory resistance values of the ventilator breathing system as specified in Section 16.10, as required by ISO 80601-2-12.
- Pressure and volume measurement accuracy may be affected by using a breathing circuit with high resistance. Accuracy was tested with Hamilton Medical devices using the breathing circuits PN 260039 for adults, PN 260189 for pediatrics, and PN 151969 for neonates.

1.5.2 Preoperational check and tests

CAUTION

- *To prevent possible patient injury, disconnect the patient from the ventilator before running the preoperational tests, and use another source of ventilatory support.*
- *To ensure the ventilator's safe operation, always run the preoperational check before using the ventilator on a patient.*
- *Do NOT use the ventilator until necessary repairs are completed and all pre-operational tests have passed.*

NOTICE

- To ensure that all breathing circuit connections are leak-tight, perform the tightness test every time you connect a circuit or change a circuit part.
- If there is a mismatch between the selected patient group and the type of flow sensor connected, the calibration fails. Ensure you are using the correct flow sensor for the patient.
- Wait 2 minutes before calibrating the flow sensor following a switch between air and heliox, or a significant change in the **Oxygen** setting. This allows the mixture to stabilize.

1.5.3 Humidifier

WARNING

- Before using a humidifier, review the *Instructions for Use* as well as the *Instructions for Use* provided with its accessories.
- To prevent possible patient injury and equipment damage, do *not* turn the humidifier on until the gas flow has started and is regulated. Turn the humidifier off before stopping gas flow.
- Adding attachments or other components/assemblies to a connected humidifier can change the pressure gradient across the ventilator, which can adversely affect ventilator performance.
- Regularly check the water traps and the breathing circuit limbs for water accumulation. Empty as required.

NOTICE

The humidifier is not powered by the ventilator when operating on the backup battery.

1.5.4 IntelliCuff

WARNING

- Never connect the tubing to any other device or connector other than to the IntelliCuff port on the ventilator and to the inflating tube on the tracheal tube or tracheostomy tube.
- Disconnect the IntelliCuff tubing from the tracheal or tracheostomy tube when IntelliCuff is turned off.
- When the IntelliCuff tubing is connected to the ventilator, IntelliCuff starts applying the last-set or default pressure as soon as a pressure above 0 is detected in the tubing, even if IntelliCuff is disabled and the ventilator is in Standby.

CAUTION

- *Use only Hamilton Medical disposable tubing with a filter and safety valve. Use of any other tubing will result in the immediate loss of cuff pressure if disconnected at the ventilator. Use of any other tubing without a filter may result in the device being contaminated.*
- *Check tubing regularly. Bent or kinked tubes can provide incorrect monitoring information.*

1.5.5 CO2 sensor setup and operation

WARNING

- Monitor the CO2 waveform (capnogram) on the ventilator display. If it appears abnormal, check the patient, settings, and the breathing circuit components, including the CO2 sensor sampling line. Adjust and replace components as appropriate.
- If the capnogram appears abnormal, inspect the CO2 airway adapter and replace if needed.
- Elevated baseline can be caused by sensor problems or an issue with the patient.
- Do *not* use any CO2 sensor/adapter if they appear to be damaged or if they fail to operate properly. Refer servicing to Hamilton Medical authorized personnel.
- Do *not* use the CO2 components when they are wet or have exterior condensation.
- In NIV and neonatal ventilation with uncuffed tubes, leaks may influence the volumetric capnogram and the measured values.
- Always connect all components securely and check for leaks according to standard clinical procedures. Displacement of the nasal or combined nasal-oral cannulas can cause lower-than-actual CO2 readings.
- Positioning of tubes and cables:
 - Do *not* position the cables or tubing in any manner that may cause patient entanglement or strangulation.
 - Support the tubing to avoid stress on the ET tube.
 - Do *not* apply excessive tension to any cable or tubing.
- During use, a system leak, such as that caused by an uncuffed ET tube or damaged CO2 sensor may significantly affect sensor readings, including flow, volume, pressure, and other respiratory parameters.
- Leakages in the breathing or sampling system may cause the displayed CO2 values to be significantly under-reported (too low).
- Keep all cleaning agents away from the CO2 sensor electrical connections.
- For the CO2 sensor/adapter, use only cleaning and disinfection agents that are recommended in the *Approved cleaning agents for CO2 components*, available on MyHamilton.
- Periodically check the sensor and tubing for excessive moisture or secretion build-up, and replace if needed. Excessive moisture can affect measurements.
- **LoFlo sidestream CO2 sensor.**
Do *not* use with patients who cannot tolerate the removal of 50 ml \pm 10 ml/min from their total minute volume. In adaptive modes (such as ASV, APVcmv, and APVsimv), the removal is fully compensated.
- **LoFlo sidestream CO2 sensor.**
Use of devices containing PVC plasticized with DEHP should be limited to the amount of time treatment is medically necessary, especially for neonates and pregnant or nursing mothers.

 **CAUTION**

- All devices are NOT protected against reanimation with a defibrillator. Disconnect the CO2 sensor before using a defibrillator on the patient.
- Always use the correct CO2 adapter. In adult patients, smaller geometrics increase airway resistance and induce low tidal volumes and intrinsic PEEP. In neonatal patients, large geometrics impede effective CO2 removal.
- Do NOT place the CO2 sensor on the patient. It can burn the skin as the sensor may reach a temperature of 46°C (115°F).
- Use during nebulization may influence the CO2 measurements. In addition, the medication can contaminate the sensor windows, causing the sensor to fail prematurely.
- **LoFlo sidestream CO2 sensor.** Remove the sampling kit sample cell from the module when not in use.
- **LoFlo sidestream CO2 sensor.** Do NOT stick finger into the sample cell receptacle.

NOTICE

- Position airway adapters with windows in a vertical, not a horizontal, position. This helps keep patient secretions from pooling on the windows. If pooling occurs, remove the adapter, rinse with water, and reconnect.
- Do not combine the neonatal CO2 airway adapter and the adult flow sensor. Doing so can increase resistance, create artifact, or lead to hypoventilation, intrinsic PEEP, or overinflation.

- Do not place the CO2 sensor/adapter between the ET tube and the elbow, as this may allow patient secretions to enter the tubing and block the adapter windows.
- The CO2 sensors and accessories that have contact with the patient are not made with natural rubber latex.
- Nitrous oxide, elevated levels of oxygen, helium, and halogenated hydrocarbons can influence the CO2 measurement.

1.5.6 Nebulization

For additional safety information related to Aerogen^s nebulizers, see the *Aerogen Solo/Aerogen Pro Instructions for Use*.

 **WARNING**

- Nebulization of drugs can cause an occlusion and increased resistance of a connected expiratory filter. Check the filter frequently for increased resistance or blockage.
- Connect the nebulizer in the inspiratory limb per your institution's policy and procedures. Connecting the nebulizer between the flow sensor and the endotracheal tube increases dead space and causes incorrect volume measurements.
- Pneumatic nebulization affects the delivered oxygen concentration.
- Nebulization can affect the accuracy of CO2 measurements.

CAUTION

To prevent the expiratory valve from sticking due to nebulized medications, regularly check and clean or replace the expiratory valve membrane and/or the expiratory filter.

NOTICE

- Pneumatic nebulization is disabled:
 - During neonatal ventilation (if needed, use an Aerogen nebulizer¹)
 - When using Hi Flow O2
 - When using heliox
- Only use approved piezo nebulizers with the HAMILTON-S1.

1.6 Ventilating the patient

This section provides the following safety information:

- Specifying patient settings
- Neonatal ventilation
- Apnea backup
- TRC settings
- P/V Tool Pro
- Noninvasive ventilation
- Using high flow oxygen therapy

1.6.1 Specifying patient settings

WARNING

- It is the clinician's responsibility to ensure that all ventilator settings are appropriate, even when "automatic" features, such as ASV, or default settings are used.
- To prevent possible patient injury:
 - Make sure the ventilator is set up for the appropriate patient group with the appropriate breathing circuit components.
 - For each patient group, make sure you select the correct patient sex and height (**Adult/Pediatric**) or weight (**Neonatal**). Correct entries help prevent hyper- or hypo-ventilation.
- The ventilator is a high-flow device that can operate with flows above 60 l/min and with a high oxygen concentration.

1.6.2 Neonatal ventilation

In addition to the information provided in this section, carefully review the information in Sections 1.5 and 1.6.

WARNING

Prolonged exposure to high oxygen concentrations may cause irreversible blindness and pulmonary fibrosis in preterm neonates. Be especially careful when performing oxygen enrichment.

¹ Not available in all markets.

CAUTION

- To prevent increased CO₂, do NOT use an adult airway adapter for neonates as it will increase dead space.
- To determine appropriate tidal and minute volumes for neonatal patients, you must consider (anatomic) dead space. Artificial airways (Y-piece, flow sensor, ET tube, CO₂ airway adapter) may increase the dead space.
- When using active humidification, prevent water accumulation in the flow sensor by ensuring that the flow sensor is positioned at a $\geq 45^\circ$ angle relative to the floor. Excess water can affect the flow sensor measurements and lead to inaccurate volume delivery, potentially resulting in hypoventilation.

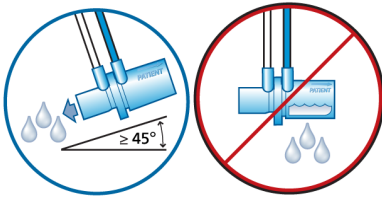

NOTICE

When switching between the Adult, Pediatric, and Neonatal patient groups, you must calibrate the flow sensor and perform the tightness test.

1.6.3 Apnea backup

CAUTION

We recommend you enable apnea back-up ventilation whenever a mode that allows spontaneous breathing is selected. Apnea backup is enabled by default.

1.6.4 TRC settings

WARNING

To ensure patient safety, check that the Pressure alarm limit is set appropriately when using TRC, as real pressure may be higher than the set pressure.

CAUTION

To prevent patient injury, be especially careful when defining TRC settings, as using the incorrect tube type or size setting can endanger the patient.

1.6.5 Noninvasive ventilation

NOTICE

- As a precaution, you must be prepared to intubate the patient and start invasive ventilation at any time while noninvasive ventilation is in use.
- The use of a mask can increase dead space. Always comply with the mask manufacturer's instructions when using noninvasive ventilation.

1.6.6 P/V Tool Pro

WARNING

Do *not* attempt to use the P/V Tool on an active patient as it can cause patient discomfort and erroneous readings.

NOTICE

- During a maneuver and for 30 seconds following the end of the maneuver, all patient alarms are silenced.
- Apnea time begins after the end of the maneuver.
- Use of the P/V Tool provides information that, in conjunction with hemodynamic data and other clinical information, may be used to optimize PEEP and other ventilator settings.
- During the maneuver, the high Pressure alarm is automatically set to Ptop + 5 cmH₂O.
When the maneuver is finished, the high Pressure alarm limit returns to the previous setting.
If IntelliCuff is connected, Pcuff may also be affected. For details, see Section 12.2.4.1.
- A calibrated flow sensor and a tight circuit produce the best results.

1.6.7 Using high flow oxygen therapy

WARNING

- Use only interfaces intended for high flow oxygen therapy that allow the patient to exhale, such as a nonocclusive high-flow nasal cannula, tracheal adapter, or tracheal mask. This is important because exhalation through the expiratory valve is not possible when using high flow oxygen therapy.
- Ensure the ventilator's gas pipeline system does not exceed the pipeline design flow capacity. If the system exceeds the flow capacity, it can interfere with the operation of other equipment using the same gas source.
- Always use active humidification during high flow oxygen therapy.

1.7 Monitoring and alarms

CAUTION

- *To prevent possible patient injury, make sure the alarm limits are appropriately set before you place the patient on the ventilator.*

- The HAMILTON-S1 oxygen monitoring function can be disabled, except when Heliox is in use. Ensure that an alternative means of oxygen monitoring is always available and enabled.
- To ensure that oxygen monitoring is always fully functional, replace an exhausted or missing O2 sensor as soon as possible or use an external monitor that complies with ISO 80601-2-55.

NOTICE

- The HAMILTON-S1 is *not* intended to be a comprehensive vital sign monitor for patients on life-support equipment. Patients on life-support equipment should be appropriately monitored by qualified medical personnel and suitable monitoring devices.
- The use of an alarm monitoring system does *not* give absolute assurance of warning for every type of issue that may arise with the ventilator. Alarm messages may *not* pinpoint a problem exactly; the exercise of clinical judgment is necessary.
- It is recommended that additional independent monitoring devices, including pulse oximeters measuring SpO2, be used during mechanical ventilation. The operator of the ventilator must still maintain full responsibility for proper ventilation and patient safety in all situations.
- Do *not* pause the audible alarm when leaving the patient unattended.
- The Auto function is not available during neonatal ventilation.

1.8 Using the trolley

WARNING

- To prevent possible personal injury and equipment damage, including tipping:
 - Lock the trolley's wheels when parking the ventilator.
 - Take care when crossing thresholds.
- To prevent accidental extubation, check the patient tubing support arm joints and secure as necessary.

1.9 Maintenance

This section provides the following safety information:

- Maintenance, cleaning, and disinfection
- Preventive maintenance

1.9.1 General maintenance, cleaning, and disinfection

WARNING

- Reprocessing of Hamilton Medical single-use products can affect the product properties and may cause injury to the patient. For example, a change to the surface structure during reprocessing may lead to a change in the tear strength or cause actual cracking. Furthermore, an altered surface structure may result in a microbial aggregation of spores, allergens and pyrogens, for example, or cause an increase in the number of particles released as a result of chemical changes in the material properties.

- To reduce the risk of cross-contamination, regularly clean and replace the fan filter. For details, see Table 13-3 and Section 13.4.1.
- To prevent patient exposure to sterilizing agents and to prevent premature deterioration of parts, sterilize parts using only the techniques recommended in Chapter 13 and in any associated *Reprocessing Guide* or *Instructions for Use* provided with each part.
- Hamilton Medical does *not* assume any liability for the proper functioning of single-use items if they are reprocessed and reused by the user.
- Always use caution when handling bacteria filters to minimize the risk of bacterial contamination or physical damage. Dispose of used filters immediately after use. Follow your hospital procedures for disposal.
- Follow the cleaning, disinfection, and sterilization procedures for each component as described in this guide and in the cleaning agent manufacturer's Instructions for Use.
- Always disconnect the device and any accessories, including CO2 sensor/adaptor, from electrical power before cleaning and disinfection to reduce the risk of electric shock.

 **CAUTION**

- Do **NOT** sterilize or immerse the CO2 sensor in liquids.
- Do **NOT** attempt to sterilize the interior components of the ventilator.
- Do **NOT** attempt to sterilize the entire device with ETO gas.
- Incorrect concentrations or residence times of sterilization agents may lead to bacterial resistance.
- To prevent premature deterioration of parts, make sure the disinfecting chemical is compatible with the part material. Use only registered/ approved cleaning and disinfection solutions, as approved by your institution's protocol, after each patient use, according to the cleaning agent manufacturer's recommendations.
- Intrusion of fluids, or immersing parts in fluids, will damage the device.
- Do **NOT** pour fluids onto the device surfaces.
- Do **NOT** use abrasives materials (for example, steel wool or silver polish), hard brushes, pointed instruments, or rough materials on surfaces.
- Thoroughly rinse all patient or airway contact component to ensure removal of residual cleaning/disinfection agents.
- Cleaning and disinfection agent residues can cause blemishes or fine cracks, especially on parts exposed to elevated temperatures during sterilization.

NOTICE

- Because sanitation practices vary among institutions, Hamilton Medical cannot specify specific practices that will meet all needs or be responsible for the effectiveness of these practices.
 - This *Operator's Manual* only provides general guidelines for cleaning, disinfecting, and sterilizing. It is the operator's responsibility to ensure the validity and effectiveness of the actual methods used.
 - For specific information on cleaning, disinfecting, and sterilizing autoclavable (reusable) accessories and components, refer to the appropriate *Reprocessing Guide* and *Instructions for Use* provided with each part.
-

1.9.2 Preventive maintenance

NOTICE

- Dispose of all parts removed from the device according to your institution's protocols. Comply with all local, state, and federal regulations with respect to environmental protection, especially when disposing of the electronic device or parts of it (for example, O₂ sensor).
 - We recommend that you document all maintenance procedures.
 - It is *not* allowed to perform service or maintenance on the device while a patient is connected.
 - If no bacteria (inspiratory) filter is used, the device must be considered contaminated and must be serviced.
-

1.9.3 O₂ sensor

NOTICE

- To prevent leakage within the ventilator, make sure an O₂ sensor is installed at all times, even if you use an external monitor or disable oxygen monitoring.
 - The paramagnetic O₂ sensor must only be replaced if it fails. In this case, have the ventilator serviced.
-

1.10 Service and testing

- To ensure proper servicing and to prevent possible physical injury, only Hamilton Medical authorized service personnel may service the ventilator using information provided in the Service Manual.
In addition, all accessories and devices must only be serviced by Hamilton Medical authorized service personnel.
- The manufacturer can only be responsible for the safety, reliability, and performance of the ventilator if all of the following requirements are met:
 - Appropriately trained personnel carry out assembly operations, extensions, readjustments, modifications, maintenance, or repairs.
 - The electrical installation of the relevant room complies with the appropriate requirements.
 - The ventilator system is used in accordance with the operator's manual.
 - Do *not* attempt service procedures other than those specified in the service manual.
- Any attempt to modify the ventilator hardware or software without the express written approval of Hamilton Medical automatically voids all warranties and liabilities.

2

System overview

2.1	Overview.....	40
2.2	Physical descriptions.....	43
2.3	Navigating the windows and controls.....	57

2.1 Overview

The HAMILTON-S1 ventilator system comprises the following main components:

- Detachable monitor with integrated alarm lamp and touch screen display
- Ventilation unit for gas mixing and control, and patient breathing circuit for gas delivery and exchange
- Oxygen monitoring using a galvanic or optional paramagnetic sensor
- Optional connections to a humidifier, IntelliCuff cuff pressure controller, SpO2 and CO2 sensors, and external data interfaces
- Trolley, shelf, or pendant mount

The ventilator system offers the following main features:

- Monitoring: Real-time waveforms, numerical monitoring, trends, loops, and Intelligent panels showing the patient's real-time breathing status, ventilator dependence, and targets, CO2 and SpO2 measurements (when enabled)
- Alarms: Adjustable and non-adjustable to ensure patient safety
- Configurable startup settings for each patient group
- Monitoring and control of the HAMILTON-H900 humidifier from the ventilator
- Monitoring and control of the IntelliCuff cuff pressure controller from the ventilator
- Transpulmonary pressure measurement
- Support for pneumatic or Aerogen nebulization

2.1.1 Standard features and options

The ventilator offers a robust set of standard equipment and features, as well as optional modes and features for the supported patient groups.

Table 2-1 lists the standard software configuration and options. Table 2-2 lists the standard equipment (hardware) and options.

Table 2-1. Standard software configuration and options

Function	Patient group	
	Adult/Pediatric	Neonatal
	Standard: X Option: O Not applicable: --	
Patient groups	X	O
Modes		
Intelligent ventilation modes		
ASV	X	--
INTELLiVENT-ASV	X	--
Volume-targeted, pressure-controlled modes		
APVcmv	X	X
APVsimv	X	X
Volume-controlled, flow-controlled modes		
(S)CMV	X	--
SIMV	X	--
Volume-controlled, flow-cycled mode		
Volume Support (VS)	X	X
Pressure-controlled modes		
DuoPAP, APRV	X	X
P-CMV	X	X
P-SIMV	X	X
SPONT	X	X
Noninvasive modes		
Hi Flow O2	X	X
NIV, NIV-ST	X	--
nCPAP-PS	--	O

Function	Patient group	
	Adult/Pediatric	Neonatal
Other functions		
P/V Tool, P/V Tool Pro	O	O
Transpulmonary pressure monitoring	X	X
Intellisync+	O	--
Flow and pressure triggers	X	X
TRC	X	X
Suctioning tool	X	X
Trends/Loops	X	X

Table 2-2. Standard equipment (hardware) configuration and options

Functions	HAMILTON-S1
Standard: X Option: O	
Trolley or shelf mount solution (selected when ordering)	X
External battery	O
Modules for external sensors/devices: CO2, SpO2, Nebulizer, Humidifier	O
Heliox ventilation	O
Extended communication ports: CompactFlash, USB, DVI, COM (RS-232), Special interface	X
Communication protocols (for use with the COM ports): HAMILTON-G5 / Polling, HAMILTON-G5 / Block, HAMILTON-G5 / Block (ACK), Galileo / Polling, DraegerTestProtocol, Humidifier	O
Paramagnetic O2 sensor	O
Paux port	X
HAMILTON-H900 humidifier integration	O
IntelliCuff cuff pressure controller integration	X

2.2 Physical descriptions

This section provides an overview of the ventilator, breathing circuit sets, and trolley.

Figure 2-1. HAMILTON-S1 with accessories

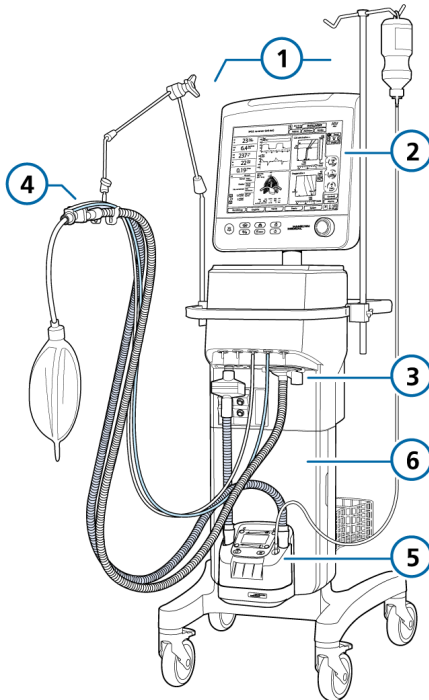

- | | |
|---------------------------------|---------------------|
| 1 Support arm and infusion arm | 4 Breathing circuit |
| 2 Display and controls | 5 Humidifier |
| 3 Breathing circuit connections | 6 Trolley |

2.2.1 About the ventilator

Figures 2-2 through 2-5 provide an overview of the device.

Figure 2-2. Front view, ventilator monitor

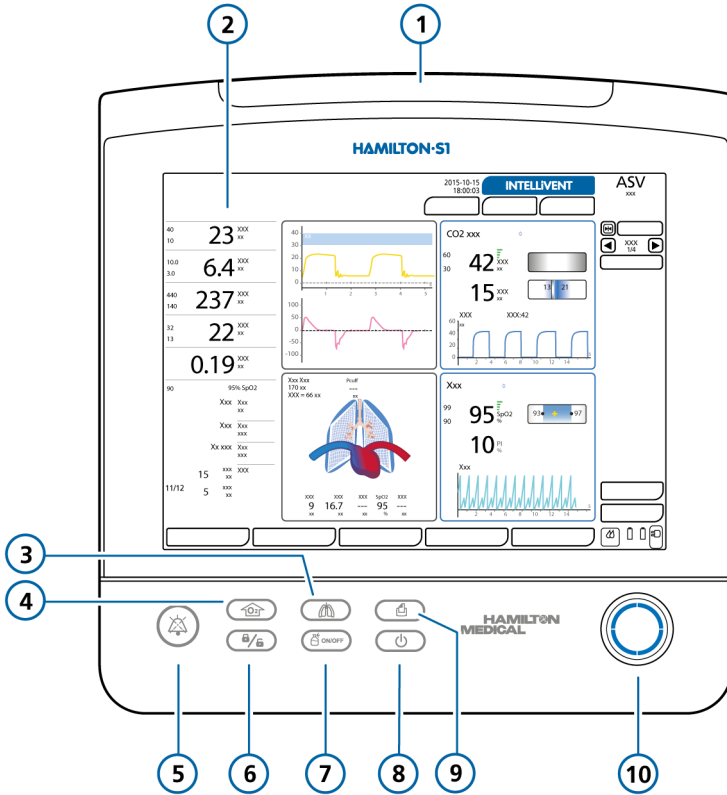

- | | | | |
|---|-----------------------------------|----|---------------------------|
| 1 | Alarm lamp* | 6 | Screen lock/unlock |
| 2 | Touch screen display (Figure 2-6) | 7 | Nebulizer key |
| 3 | Manual breath key | 8 | Standby key |
| 4 | O2 enrichment key | 9 | Print screen key |
| 5 | Audio Pause key | 10 | Press-and-Turn (P&T) knob |

* The alarm lamp illuminates in blue when heliox is in use.

Figure 2-3. Front view, ventilator body

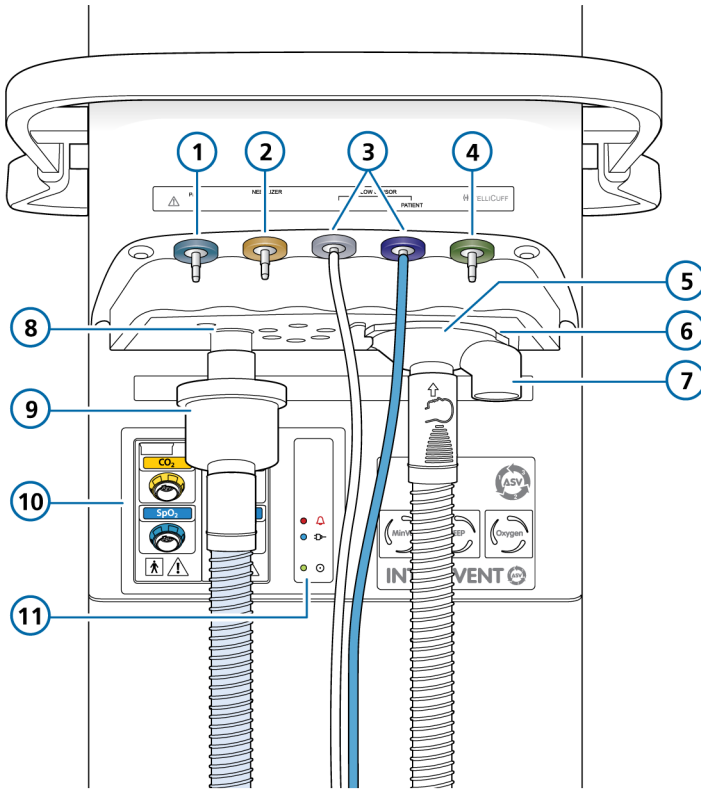





1	Paux port	7	Exhaust port
2	Nebulizer port	8	 To patient inspiratory port
3	 Flow sensor connection ports	9	Inspiratory filter
4	 IntelliCuff port	10	CO2/SpO2/Aerogen/Humidifier option module ports
5	Expiratory valve set	11	Status indicator panel (Section 2.2.1.1)
6	 From patient expiratory port		

Figure 2-4. Rear view, ventilator body



- | | | | |
|---|---|----|----------------------------------|
| 1 | Fan filter | 8 | AC power socket |
| 2 | Serial number label | 9 | Monitor cable |
| 3 | Power button | 10 | Fuse compartment |
| 4 | High-pressure air DISS or NIST inlet fitting | 11 | Oxygen sensor with cover |
| 5 | High-pressure oxygen DISS or NIST inlet fitting (for heliox, see Section 3.3) | 12 | Potential equalization conductor |
| 6 | High-pressure gas water trap with filter | 13 | RS-232 COM1, COM2 ports |
| 7 | Reservoir pressure relief valve exhaust | 14 | Special interface |

Figure 2-5. Rear view, ventilator monitor

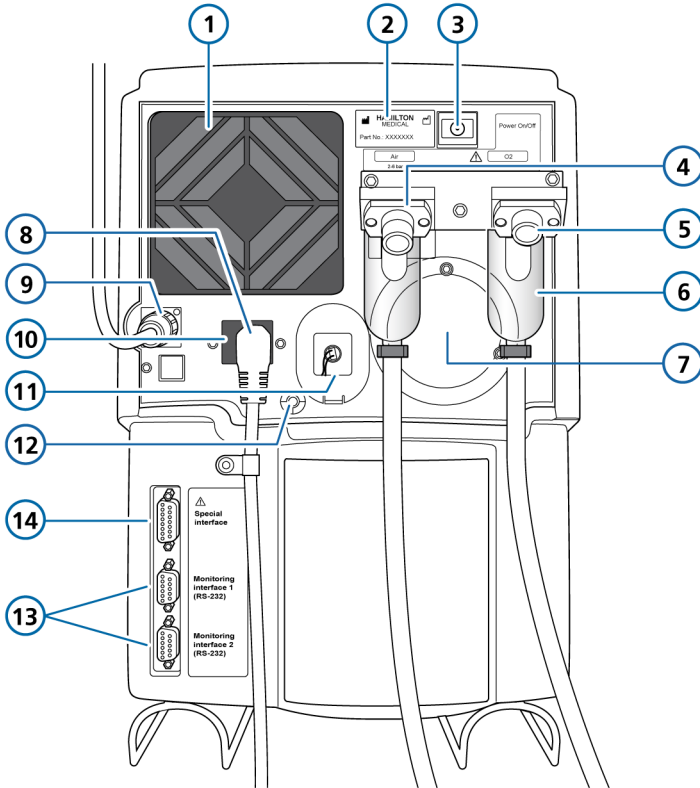
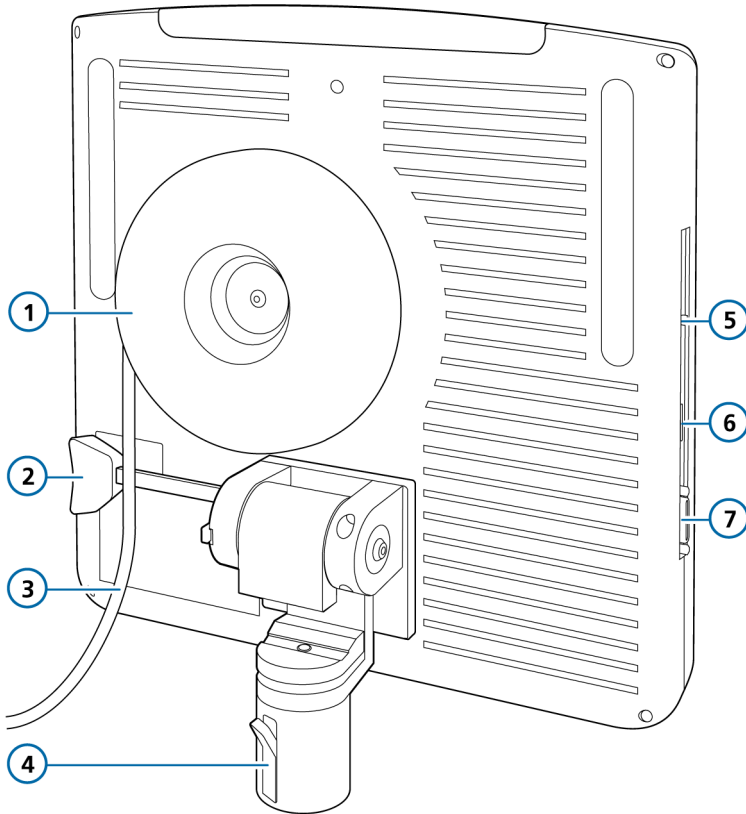



- | | | | |
|---|--|---|-----------------------|
| 1 | Monitor cable storage | 5 | CompactFlash port |
| 2 | Tilt-release lever | 6 | USB port |
| 3 | Monitor cable | 7 | DVI-I connection port |
| 4 | Mounting post with swivel lock/
release latch | | |

⚠ CAUTION! For training purposes only. Not for use with a connected patient.

2.2.1.1 About the status indicators on the ventilator

Indicator lights on the front of the ventilator unit show important ventilation status information.

Table 2-3. Status indicator panel

Symbol	Description
	Alarm indicator. Solid red when an alarm is active. For alarm related information, see Chapter 9.
	Primary power indicator. Solid blue when the ventilator is plugged in and connected to primary (AC) power.
	Power indicator. Solid green when the ventilator is turned on.

2.2.2 About the main display

Directly access all the windows for mode, controls, alarms, and monitoring from the main display during normal ventilation (Figure 2-6).

Figure 2-6. Main display

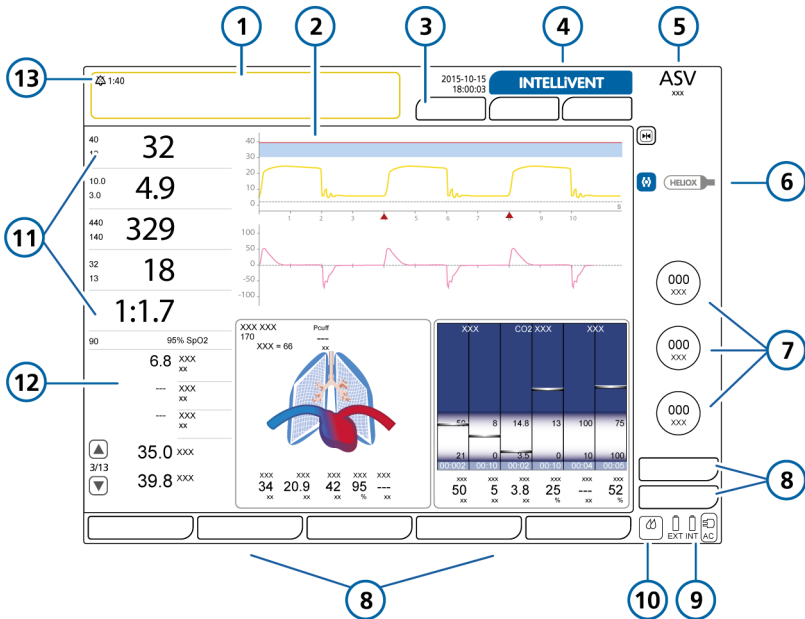

- | | | | |
|---|---|----|---|
| 1 | Message bar (color coded) | 8 | Window buttons: Alarms, Controls, Monitoring, Graphics, Tools, Events, System |
| 2 | Configurable graphic display | 9 | Power source |
| 3 | Window buttons: Patient, Additions, Modes | 10 | Humidifier quick access icon |
| 4 | INTELLiVENT-ASV button | 11 | Main monitoring parameters (MMP) |
| 5 | Active mode and selected patient group | 12 | Secondary monitoring parameters (SMP) |
| 6 | IntelliCuff quick access icon and/or Heliox icons (when installed and selected) | 13 | Audio Pause indicator and countdown timer |
| 7 | Main controls for the active mode | | |

2.2.3 About the patient breathing circuits

For details about connecting and setting up the breathing circuit, see Section 3.4.

When setting up the patient breathing circuit, keep in mind the following important points:

- To prevent patient or ventilator contamination, be sure to connect a bacteria (inspiratory) filter or HMEF between the patient and the inspiratory port.

- Connect the CO2 sensor in front of or behind the flow sensor, according to your institution's protocol.
- During neonatal ventilation with active humidification, prevent water accumulation in the flow sensor by ensuring that the flow sensor is positioned at a $\geq 45^\circ$ angle relative to the floor.

Figure 2-7. Adult/pediatric breathing circuits

Adult/Ped: Dual limb with humidifier

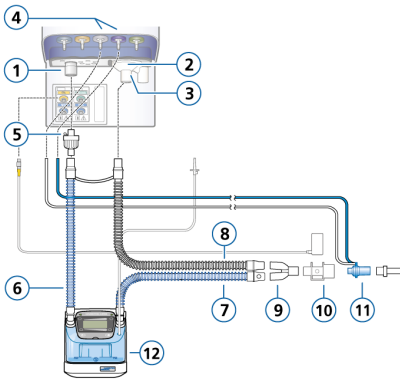

Adult/Ped: Coaxial with HMEF

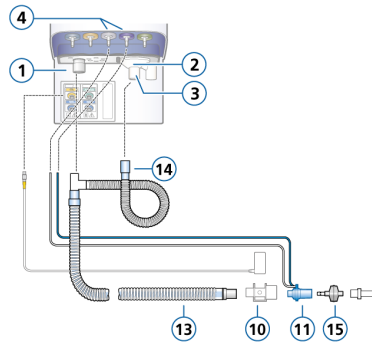

- | | | | |
|---|---|----|-------------------------------------|
| 1 | To patient inspiratory port | 9 | Y-piece |
| 2 | From patient expiratory port | 10 | CO2 sensor/adaptor |
| 3 | Expiratory valve set | 11 | Flow sensor |
| 4 | Flow sensor connection ports | 12 | Humidifier |
| 5 | Bacteria filter | 13 | Coaxial inspiratory/expiratory limb |
| 6 | Inspiratory limb to humidifier | 14 | Expiratory limb extension |
| 7 | Heated inspiratory limb with temperature sensor, to patient | 15 | HMEF |
| 8 | Heated expiratory limb | | |

Figure 2-8. Adult/pediatric breathing circuit: high flow oxygen therapy

Adult/Ped: Dual limb, high flow oxygen therapy

Adult/Ped: Single limb, high flow oxygen therapy

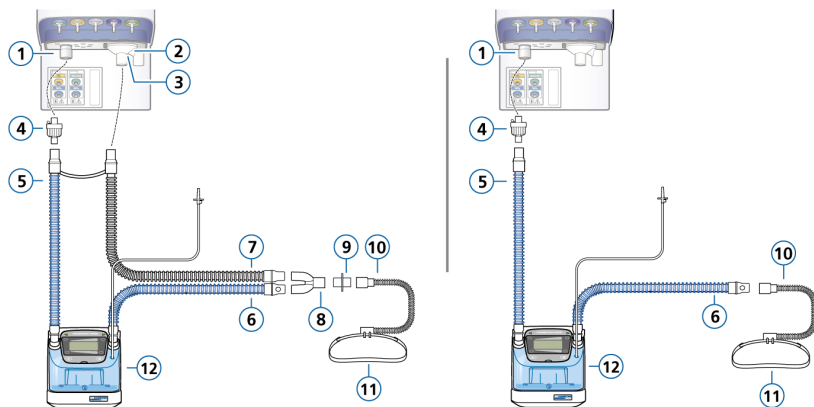

- | | | | |
|---|---|----|------------------------|
| 1 | To patient inspiratory port | 7 | Heated expiratory limb |
| 2 | From patient expiratory port | 8 | Y-piece |
| 3 | Expiratory valve set | 9 | Adapters (various) |
| 4 | Bacteria filter | 10 | Nasal cannula |
| 5 | Inspiratory limb to humidifier | 11 | Attachment strap |
| 6 | Heated inspiratory limb with temperature sensor, to patient | 12 | Humidifier |

Figure 2-9. Neonatal breathing circuits

Neonatal/pediatric: Dual limb with humidifier

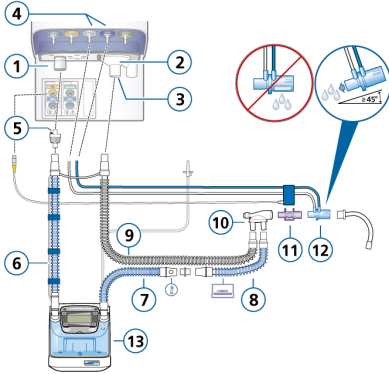

Neonatal/pediatric: Dual limb with HMEF

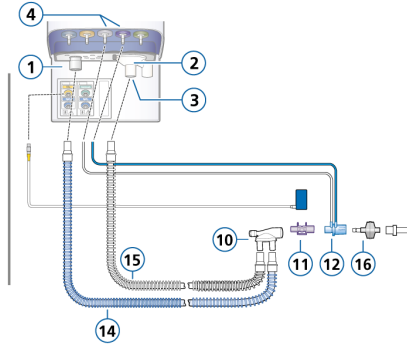

- | | | | |
|---|---|----|------------------------|
| 1 | To patient inspiratory port | 9 | Heated expiratory limb |
| 2 | From patient expiratory port | 10 | Y-piece |
| 3 | Expiratory valve set | 11 | CO2 sensor/adaptor |
| 4 | Flow sensor connection ports | 12 | Flow sensor |
| 5 | Bacteria filter | 13 | Humidifier |
| 6 | Inspiratory limb to humidifier | 14 | Inspiratory limb |
| 7 | Heated inspiratory limb with temperature sensor, to patient | 15 | Expiratory limb |
| 8 | Unheated inspiratory limb extension, for use in incubator | 16 | HMEF |

Figure 2-10. Neonatal breathing circuits: high flow oxygen therapy

Neonatal/pediatric: Dual limb, high flow oxygen therapy

Neonatal/pediatric: Single limb, high flow oxygen therapy

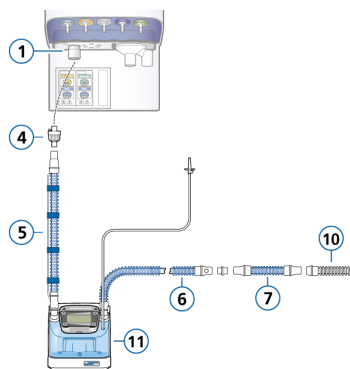
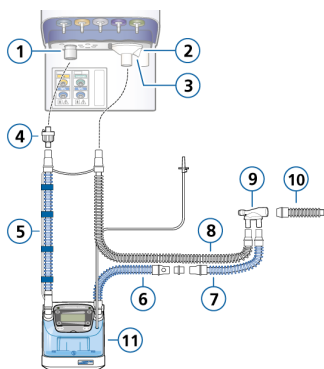

- | | | | |
|---|---|----|---|
| 1 | To patient inspiratory port | 7 | Unheated inspiratory limb extension, for use in incubator |
| 2 | From patient expiratory port | 8 | Heated expiratory limb |
| 3 | Expiratory valve set | 9 | Y-piece |
| 4 | Bacteria filter | 10 | Connection to patient interface (options not shown) |
| 5 | Inspiratory limb to humidifier | 11 | Humidifier |
| 6 | Heated inspiratory limb with temperature sensor, to patient | | |

Figure 2-11. Neonatal breathing circuit: nCPAP-PS

Neonatal: nCPAP-PS

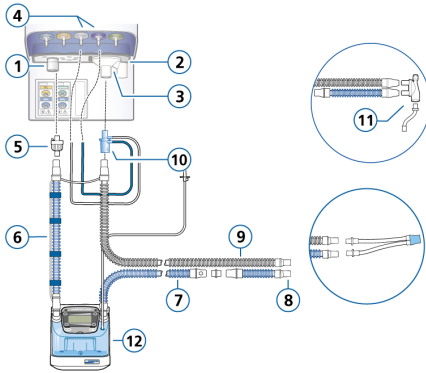

1	To patient inspiratory port	7	Heated inspiratory limb with temperature sensor, to patient
2	From patient expiratory port	8	Unheated inspiratory limb extension, for use in incubator
3	Expiratory valve set	9	Heated expiratory limb
4	Flow sensor connection ports	10	Flow sensor (connected to expiratory port)
5	Bacteria filter	11	Y-piece
6	Inspiratory limb to humidifier	12	Humidifier

2.2.4 About the trolley and mounting variations

The HAMILTON-S1 can optionally be ordered with a standard trolley, pendant mount, or a shelf mount solution. The trolley has space for oxygen cylinders.

2.2.4.1 Preparing the trolley for intrahospital transport

Before proceeding, review the safety information in Chapter 1.

WARNING

- *Only* the components listed in this section are approved for intrahospital transport.
- Use of additional items, such as a patient support arm, can result in the trolley tipping over.

CAUTION

To prevent possible equipment damage, avoid overloading the HAMILTON-S1's basket and tray, or placing objects on the HAMILTON-S1 that might compromise its stability.

NOTICE

The O2 cylinder can only be mounted on the Universal trolley.

If using a HAMILTON-S1 trolley, the ventilator and its components, as well as the trolley, **must be** configured and positioned as follows during transport within the hospital:

- The oxygen cylinders must be securely attached to the trolley.
- *Only* the following components are allowed to be connected during transport:
 - Breathing circuit
 - Flow sensor
 - CO2 sensor (mainstream or sidestream)
 - SpO2 sensor, including Masimo adapter
 - Infusion arm (water bottle holder)

2.2.5 Setting up the monitor

The HAMILTON-S1 offers multiple mounting options for the monitor. You can also adjust the tilt and view angle of the monitor.

2.2.5.1 Mounting the monitor

The following mounting options are available for the ventilator monitor:

- Top of the trolley (1)
- Trolley rail (2)
- Standard hospital rail (3)
- Shelf (4)
- Pendant system (4)

Figure 2-12. Mounting options

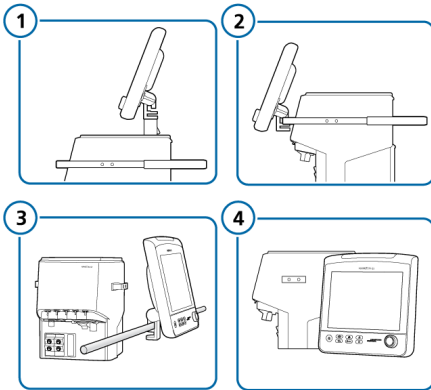

Contact your Hamilton Medical representative for more information.

2.2.5.2 Adjusting the monitor

You can adjust the monitor's position and set it to the desired orientation and angle by turning and tilting it, as needed.

To tilt the monitor up and down

1. Pull the tilt handle toward you (1), and adjust the angle of the monitor (2).
2. Release the handle to lock the monitor's position.

Figure 2-13. Tilting the monitor up and down

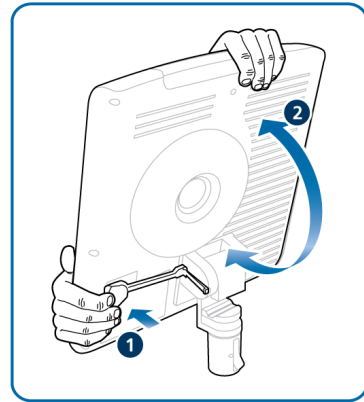

To turn the monitor side to side

1. Press the bottom of the monitor post latch to unlock it (1), and turn the monitor to the desired angle (2).
2. Press the top of the latch to lock the monitor's position.

Figure 2-14. Turning the monitor side to side

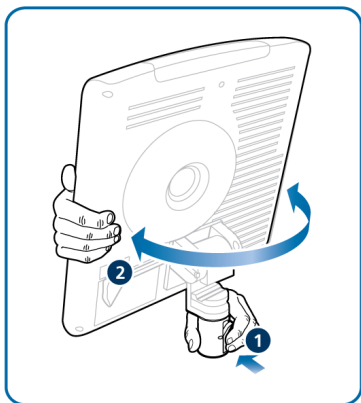

2.3 Navigating the windows and controls

Use the touch screen and the Press-and-turn knob (referred to as the *P&T knob*) to access data and specify settings.

You interact with the HAMILTON-S1 user interface as follows:

- Touch elements on the display to open windows and make selections.
- Use the P&T knob to select, specify, and confirm selections. A selected item is highlighted in yellow.

This section describes how to navigate the interface.

2.3.1 Accessing windows

To open a window

- ▶ Do any of the following to open a window:
 - Touch the button and any needed tabs.
 - Turn the P&T knob to move the cursor to the button or tab, then press the P&T knob.

To close a window

- ▶ Do any of the following to close a window:
 - Touch the window button again.
 - Touch the **X** button.
 - Turn the P&T knob to move the cursor to the **X** button, then press the P&T knob.

2.3.2 Adjusting controls

Specifying settings involves *activating* a control, *setting* a value, and *confirming* the setting.

To adjust a control setting

1. **Activate** the control by doing any of the following:
 - Touch the control to select and activate it.
 - Turn the P&T knob to move the cursor to the control, then press the P&T knob to activate it.

The activated control is orange.

Figure 2-15. Selected control (yellow outline), activated control (orange)

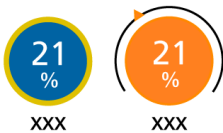

2. **Adjust** the value by turning the P&T knob to increase or decrease the value.
3. **Confirm** the setting by doing any of the following:
 - Touch the control again.
 - Press the P&T knob.

The new setting is immediately applied.

2.3.3 Selecting list items

Some selections are presented in a scrollable list.

To select a list item

1. In a list, touch the scroll bar to select and activate it.
2. Turn the P&T knob to scroll through the list, and when the desired selection is highlighted, press the knob to select it.

3

Preparing the ventilator

3.1	Overview.....	60
3.2	Connecting to a power source	60
3.3	Connecting the oxygen supply	61
3.4	Setting up the patient breathing circuit	62
3.5	Setting up esophageal/transpulmonary pressure monitoring.....	66
3.6	Turning the ventilator on and off	66

3.1 Overview

Preparing the ventilator for use comprises the following steps:

To ...	See ...
Connect to a power source.	Section 3.2
Connect the oxygen supply.	Section 3.3
Set up the patient breathing circuit, including performing the preoperational check.	Section 3.4
Connect external devices and sensors.	Chapter 4
Turn on the ventilator.	Section 3.6
Select the patient group, mode, and alarm limits, and enter patient data.	Chapter 5

3.2 Connecting to a power source

Before proceeding, review the safety information in Chapter 1.

Always check the reliability of the primary power outlet before plugging in the ventilator. When connected to primary power, the AC power symbol in the bottom right corner of the display shows a frame around it. In addition, the primary power symbol on the status indicator panel is lit.

To connect the ventilator to a primary power supply

1. Connect the ventilator to an outlet that supplies AC power.
Make sure the power cord is well seated into the ventilator socket and secured with the power cord retaining clip to prevent unintentional disconnection.
2. Connect one end of a grounding cable to the equipotential grounding post on the ventilator (Figure 2-4) and the other to a properly grounded outlet.

3.2.1 Using battery power

A mandatory backup battery protects the ventilator from low power or failure of the primary power source. The backup battery is labeled INT on the ventilator.

When the primary power source fails, the ventilator automatically switches to operation on backup battery with no interruption in ventilation. An alarm sounds to signal the switch-over. Silence the alarm to confirm notification of the power system change and reset the alarm.

If battery power is completely lost, a buzzer sounds continuously for at least two minutes.

Batteries are charged whenever the ventilator is connected to the primary power supply, whether or not it is turned on.

The battery and power source symbols in the bottom right corner of the display show the power source in use. See Table 3-1. A frame around a power symbol indicates the current ventilator power source.

An optional second battery is available. It is labeled EXT on the display, and is only shown when installed.

Figure 3-1. Power source indicators on display

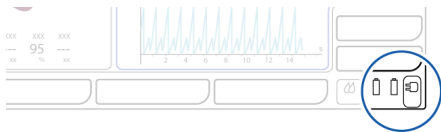







Table 3-1. Battery/power state

Power icon on display	Battery/power state
	Device is plugged into primary power and the battery is charging.
	Device is running on battery power.
	Battery is fully charged.
	Battery is partially charged.
	Battery has less than 10% charge left.
	Battery is either defective or not installed.
Power icon on Status indicator panel	See Section 2.2.1.1.

If a battery is not fully charged, recharge it by connecting the ventilator to the primary power source. For details, see Section 16.4.

Chapter 13 describes how to replace the optional battery.

3.3 Connecting the oxygen supply

Before proceeding, review the safety information in Chapter 1.

High-pressure oxygen, provided by a central gas supply or a gas cylinder, is supplied through DISS or NIST male gas fittings.

The ventilator uses high-pressure oxygen, air, and heliox from wall supplies, cylinders, or the VENTILAIR II medical air compressor. With the optional cylinder holder, you can mount oxygen cylinders to the trolley. If you use gases from cylinders, secure the cylinders to the trolley with the accompanying straps.

To connect the gas supply to the ventilator

- ▶ Connect the gas hose to the ventilator's oxygen inlet fitting (Figure 2-4).

3.3.1 Working with heliox as a gas source

Before proceeding, review the safety information in Chapter 1.

Heliox is a mixture of helium and oxygen, and can be indicated for patients in cases of acute and life-threatening upper airway obstruction. This action is taken as a temporary measure to provide a decrease in the patient's work of breathing while the cause of the obstruction is treated.

Administering heliox can make it easier to ventilate, because its lower density can allow a patient to produce inspiratory and expiratory flows with less turbulence.

3.3.2 Selecting the gas source type

Before starting ventilation, be sure to select the appropriate gas source.

You set the source in Standby mode.

To select the gas source

1. In Standby mode, open the System > Gas Source window.
2. Touch the appropriate button for the desired gas source.
Select **Air** or **Heliox** as appropriate.
When Heliox is selected, the alarm lamp on top of the display is lit blue.
3. Close the window.
4. Calibrate the flow sensor.

Figure 3-2. Gas source window

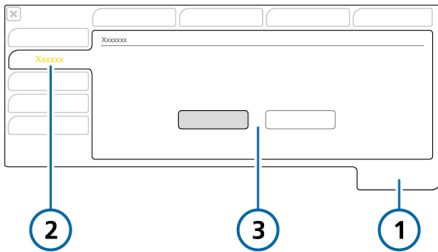

- 1 System
- 2 Gas Source
- 3 Air, Heliox²

3.4 Setting up the patient breathing circuit

Before proceeding, review the safety information in Chapter 1.

Connecting the breathing circuit comprises the following steps.

For neonatal ventilation, see Chapter 6.

To ...	See ...
Install the expiratory valve.	Section 3.4.2
Select the appropriate breathing circuit and components.	Section 3.4.3
Assemble the breathing circuit.	Section 3.4.4
Adjust the position of the breathing circuit.	Section 3.4.5
Connect external devices and sensors.	Chapter 4
Perform any required tests, calibrations, and the preoperational check.	Chapter 5

² If the option is installed and activated.

3.4.1 Breathing circuit connections on the ventilator

Figure 3-3 illustrates the key ports on the ventilator for connecting the breathing circuit set.

For breathing circuit diagrams, see Section 2.2.3.

Figure 3-3. Key connection ports, front of ventilator

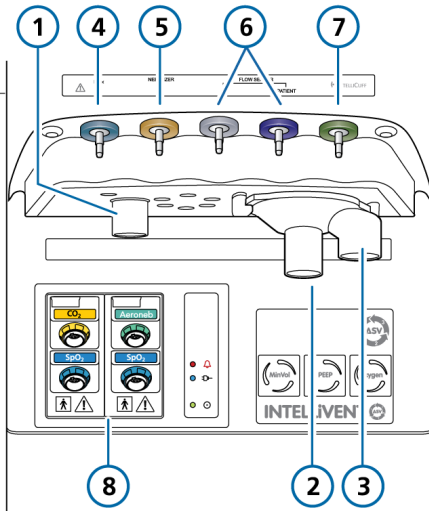

- | | |
|--------------------------------|---|
| 1 To patient inspiratory port | 5 Nebulizer port |
| 2 From patient expiratory port | 6 Flow sensor connection ports |
| 3 Expiratory valve exhaust | 7 IntelliCuff tubing port |
| 4 Paux port | 8 CO ₂ , SpO ₂ , Aerogen, and Humidifier module ports, if installed |

3.4.2 Working with the expiratory valve set

This section describes how to assemble, install, and disassemble the expiratory valve set.

To assemble/install the expiratory valve set

- ▶ Position the expiratory valve set (Figure 3-4) in the expiratory port (1) and twist clockwise until it locks into place (2).

Figure 3-4. Installing the expiratory valve set

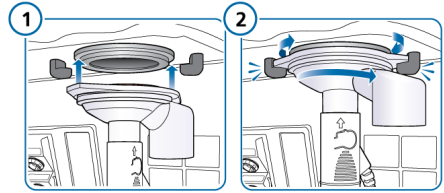

To disassemble the expiratory valve set

- ▶ Remove the expiratory valve set from the expiratory valve port on the ventilator.

3.4.3 Selecting the breathing circuit components

Select the correct breathing circuit parts for your patient.

For neonatal ventilation, see Chapter 6.

Table 3-2. Breathing circuit component specifications

Patient data/ Component	Adult	Pediatric
Patient height (cm)	> 130	30 to 150
IBW (kg)	> 30	3 to 48
Tracheal tube ID (mm)	> 4	> 4
Breathing circuit limb ID (mm) ³	15 to 22	10 to 22
Flow sensor	Adult/Ped	Adult/Ped
CO2 airway adapter	Adult/Ped ⁴	Adult/Ped ⁴

3.4.3.1 Using a filter in the breathing circuit

Before proceeding, review the safety information in Chapter 1.

Inspiratory bacteria filter

To prevent patient or ventilator contamination, be sure to connect a bacteria (inspiratory) filter or HMEF between the patient and the inspiratory port.

For neonatal patients, use a neonatal-pediatric bacteria (inspiratory) filter or HMEF.

If no inspiratory filter is used, the exhaled gas can contaminate the ventilator. If you are not using an inspiratory filter, and an exhalation obstructed alarm is generated, the ventilator may be contaminated. Have the ventilator serviced.

Expiratory bacteria filter

Before using an expiratory filter with nebulization, review the safety information in Section 1.5.6.

An expiratory filter is not required on the HAMILTON-S1, but you may use one according to your institution's protocol. It is not required because the expiratory valve design prevents internal ventilator components from coming into contact with the patient's exhaled gas.

If you use an expiratory filter, place it on the patient side of the expiratory valve cover. Monitor closely for increased expiratory circuit resistance.

An Exhalation obstructed alarm may also indicate excessive expiratory circuit resistance. If the Exhalation obstructed alarm occurs repeatedly, remove the expiratory filter immediately. If you otherwise suspect increased expiratory circuit resistance, remove the expiratory filter or replace the filter to eliminate it as a potential cause.

Heat and moisture exchanging filter (HMEF)

The HMEF is a passive humidification component used together with a bacteria filter. Use an HMEF when ventilating with a coaxial breathing system.

³ When using coaxial breathing sets, follow the manufacturer's recommendations for each patient group.

⁴ When tracheal tube ID > 4 mm.

3.4.4 Assembling the patient breathing circuit

Assemble the appropriate breathing circuit for your patient. Commonly used standard breathing circuit configurations are illustrated in Section 2.2.3.

For neonatal ventilation, see Chapter 6.

3.4.4.1 Connecting the flow sensor

NOTICE

To prevent inaccurate flow sensor readings, make sure the flow sensor is correctly connected.

Before proceeding, review the safety information in Chapter 1.

To connect a flow sensor to the breathing circuit

1. Insert a flow sensor into the breathing circuit in front of the patient connection.

See also the breathing circuit diagrams in Section 2.2.3.

Flow sensor connection dual limb circuit, Y-piece

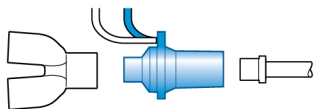

Flow sensor connection coaxial circuit

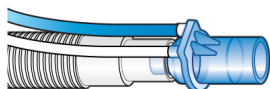

2. Attach the blue and clear tubes to the flow sensor connection ports on the ventilator (Figure 3-3).

The blue tube attaches to the blue connection port. The clear tube attaches to the silver connection port.

3. Calibrate the flow sensor and perform the Tightness test. See Section 5.4.

3.4.5 Positioning the breathing circuit

NOTICE

- To prevent water accumulation in the flow sensor and tubing, position the flow sensor tubing on top of the flow sensor.
- Ensure there is no undue stress placed on any tubing or cables.

After assembly, position the breathing circuit so that the hoses will not be pushed, pulled, or kinked as a result of a patient's movement, transport, or other activities, including scanner bed operation and nebulization.

The next step is to perform all required tests, calibrations, and the preoperational check. See Chapter 5.

3.5 Setting up esophageal/transpulmonary pressure monitoring

The Paux port allows you to use pressure readings other than airway pressure (Paw), for example, from an esophageal balloon catheter, for monitoring purposes. Transpulmonary pressure is also calculated using a combination of the Paw and Paux pressures.

To display Paux-related parameters

1. Connect an esophageal catheter to the Paux port on the front of the ventilator (Figure 2-3).
2. Open the Monitoring > Paw/Paux window.
3. Touch the **Pes (Paux)** button to activate Paux as the standard pressure input.

To revert to using airway pressure, touch the **Paw** button.

The associated pressure-related parameters are available in the Monitoring window. For details, see Section 8.5.

3.6 Turning the ventilator on and off

To turn on the ventilator

- ▶ Press the **Power** button on the back of the ventilator.

The ventilator runs a self-test. After a short time, the Standby window is displayed.

Proceed with setting up the ventilator and patient, as appropriate.

Figure 3-5. Power button



To turn off the ventilator

Note that while using IntelliCuff, you must first deflate the cuff and turn off the device before turning off the ventilator.

1. From active ventilation, press the **Standby** key to open the Activate Standby window.
2. Touch the **Activate standby** button to confirm.
3. Press the power button on the back of the ventilator.

The ventilator turns off.

In the event of a technical fault or the device will not turn off

- ▶ Press and hold the **Power** button (Figure 2-4) on the back of the device for about 10 seconds to turn off the ventilator.

4

Setting up external devices and sensors

4.1	Overview.....	68
4.2	Installing a module.....	68
4.3	Setting up a humidifier.....	68
4.4	Setting up the IntelliCuff cuff pressure controller.....	69
4.5	Setting up CO2 monitoring.....	70
4.6	Setting up SpO2 monitoring.....	74
4.7	Enabling sensors.....	74
4.8	Setting up nebulization.....	75
4.9	Connecting to an external patient monitor or other device.....	76

4.1 Overview

The HAMILTON-S1 supports a variety of external devices and sensors for ventilation, including:

- Humidifier
- IntelliCuff cuff pressure controller
- CO2 monitoring sensors
- Pulse oximetry (SpO2 monitoring) sensors
- Nebulizers

This chapter describes how to set them up for ventilation.

4.2 Installing a module

For SpO2 and CO2 sensors, and Aerogen nebulizer use, the associated option module must be installed. An additional HAMILTON-H900 humidifier module is also available.

To install a module

1. If present, remove the cover plate from the module slots.
2. Slide in the module until it clicks into place.

Figure 4-1. Sensor, nebulizer, and humidifier connection modules

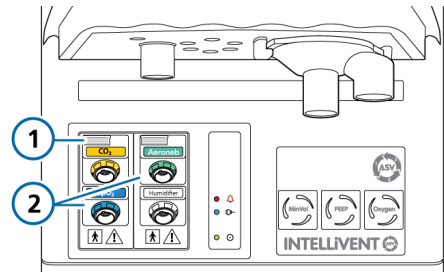

- | | |
|------------------|----------------------|
| 1 Release button | 2 Connection modules |
|------------------|----------------------|

To remove a module

1. Press the release button on top of the module, and pull the module out.
2. If desired, replace the module slot cover.

4.3 Setting up a humidifier

Before proceeding, review the safety information in Chapter 1.

When used with the HAMILTON-H900 humidifier, the ventilator supports integration of humidifier operation and data monitoring directly from the ventilator display⁵.

Other humidifiers are supported, without the integration. To connect a non-Hamilton Medial humidifier, refer to the manufacturer's instructions for use.

⁵ Not available in all markets.

To connect the HAMILTON-H900 humidifier to the ventilator

1. First, enable the Humidifier option on the ventilator, and ensure either a COM port is configured for the humidifier or the Humidifier module is installed. For details, see Sections 14.11.3 and 14.6.3.
2. Connect the HAMILTON-H900 humidifier power cable to the dedicated power socket on the ventilator (Figure 2-4).
3. Connect a potential equalization cable to the humidifier and to a grounding socket at your facility.
4. Connect the communication cable to the bottom of the humidifier, and to the ventilator.

On the ventilator, you can either connect the cable to the configured RS-232 COM port on the back of the ventilator (option 1 below) or to the Humidifier module on the front (option 2 below), whichever is available.

Figure 4-2. Connecting the humidifier communication cable to COM port (1) or to module port (2)

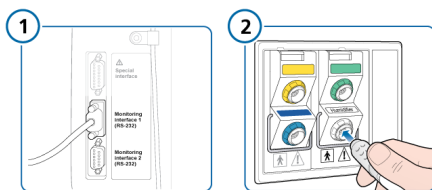

If data export is configured, humidifier data is also transmitted from the ventilator to an external monitoring system.

For additional details about:

- Connecting the humidifier to the breathing circuit, see Section 2.2.3.
- Working with the humidifier, see the *HAMILTON-H900 Instructions for use*.
- Controlling the humidifier from the ventilator, see Chapter 12.

4.4 Setting up the IntelliCuff cuff pressure controller

The ventilator supports the use of an optional IntelliCuff cuff pressure controller, and offers integrated operation and monitoring of the device.

For details on using IntelliCuff during ventilation, see Section 12.2.

The following options are available: Integrated and standalone

Integrated IntelliCuff

The IntelliCuff port on the front of the ventilator connects inside the ventilator to an integrated automatic cuff pressure controller module.

The integrated cuff controller comprises a small pump and pressure monitoring device with two independent pressure sensors. When in use, the cuff controller increases the cuff pressure as needed, compensates for leaks, and reduces any excess pressure, if required. To aid with intubation and extubation, the cuff controller generates a small vacuum to completely deflate the cuff.

For setup details, see Section 4.4.2.

Standalone IntelliCuff

IntelliCuff is connected as a standalone device, and all controls and operations are available on the device itself.

For details on using IntelliCuff as a standalone device, see the *IntelliCuff Instructions for use*.

4.4.1 About the IntelliCuff tubing

The IntelliCuff connector allows connection only from the ventilator end (with the shut-off valve) of the Hamilton Medical cuff pressure tubing.

The ventilator end of the tubing has a built-in shut-off valve, which prevents loss of cuff pressure in the event of a disconnection from the ventilator. The patient end of the tubing fits the connector (pilot balloon) for cuff pressure measurement on the ET tube or the tracheotomy cannula.

4.4.2 Setting up IntelliCuff

For each patient, you connect the cuff and tubing to the patient and to the ventilator, and specify the desired settings.

To connect the cuff tubing

1. Connect the cuff tubing to the patient as described in the *IntelliCuff Instructions for use*.
2. Connect the other end of the cuff tubing to the IntelliCuff port on the front of the ventilator (Figure 2-3).

Figure 4-3. Connect IntelliCuff tubing to IntelliCuff port on ventilator (1)

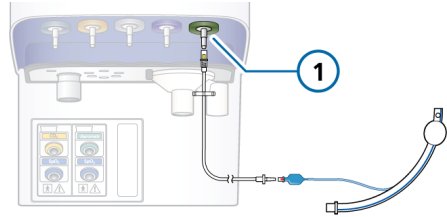

To enable the IntelliCuff option on the ventilator, see Section 14.11.3.

For operation details, see Section 12.2 and the *IntelliCuff Instructions for use*.

4.5 Setting up CO₂ monitoring

Before proceeding, review the safety information in Chapter 1.

CO₂ monitoring data is helpful for the assessment of the patient's airway integrity or ensuring proper endotracheal tube placement, among other applications.

Two CO₂ measurement options are available: mainstream and sidestream. Which option you use depends on the clinical setting.⁶

Enabling CO₂ measurement on the ventilator requires enabling the CO₂ hardware (in Configuration) and enabling the sensor. In addition, the CO₂ module must be installed.

⁶ The volumetric capnogram is only available when using a mainstream CO₂ sensor.

Table 4-1. CO2 measurement overview

For details about ...	See ...
Mainstream CO2 measurement, connection, and use	Section 4.5.1
Sidestream CO2 measurement, connection, and use	Section 4.5.2
Enabling the CO2 hardware	Section 14.11.3
Installing a module	Section 4.2
Enabling the CO2 sensor	Section 4.7

4.5.1 Mainstream CO2 measurement

The CO2 monitoring option comprises the following components (shown in Figure 4-4): communication module, airway adapter, and CO2 sensor.

The sensor generates infrared light and beams it through the airway adapter to a detector on the opposite side. CO2 from the patient, flowing through the mainstream airway adapter, absorbs some of this infrared energy.

The system determines the CO2 concentration in the breathing gases by measuring the amount of light absorbed.

The ventilator displays CO2 measurements as numeric values, waveforms, trends, and loops.

Figure 4-4. Mainstream CO2 monitoring components and assembly

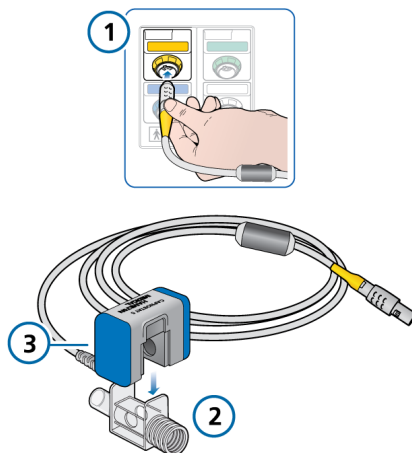

- 1 Communications module with CO2 connection port
- 2 Airway adapter
- 3 CO2 sensor

4.5.1.1 Connecting the mainstream CO2 sensor

⚠ CAUTION

When using active humidification, prevent water accumulation in the CO2 adapter/sensor by ensuring that they are positioned at a $\geq 45^\circ$ angle relative to the floor. Excess water can affect the sensor measurements.

NOTICE

You must use an appropriate adapter to connect the mainstream CO2 sensor to a neonatal flow sensor.

Before proceeding, review the safety information in Chapter 1.

Ensure the CO2 sensor and adapter are clean and dry before connection.

To set up mainstream CO2 monitoring

1. Connect the sensor cable to the CO2 connection port (1) on the ventilator (see Figure 4-4).
2. Attach the CO2 sensor (3) to the airway adapter (2), aligning the arrows on both components.
Press the components together until they click.
3. When connecting a CO2 sensor for the first time, perform the zero calibration of the sensor/adapter, if needed, as described in Section 5.4.5.
4. Connect the sensor/adapter to the breathing circuit proximal to the patient, in a vertical position. See Figure 4-5.

Do *not* place the airway adapter between the ET tube and the elbow, as this may allow patient secretions to accumulate in the adapter.⁷

The sensor cable should face away from the patient.

5. Secure the sampling line safely out of the way.

Figure 4-5. Connecting CO2 sensor/adapter (1) to breathing circuit (Adult/Ped shown)

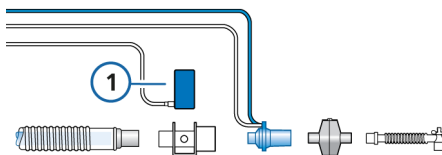

To verify the quality of the connection

- ▶ Check the capnogram (CO2 waveform) on the ventilator display.
If CO2 levels are higher than expected, check the patient condition. If you determine that the patient's condition is not contributing, calibrate the sensor (Section 5.4.5).

To remove the sensor cable

- ▶ Pull back on the connector sheath and disengage from the connection port on the ventilator.

⁷ You can connect the CO2 sensor in front of or behind the flow sensor according to your institution's protocol.

4.5.2 Sidestream CO2 measurement

The LoFlo CO2 module is a sidestream CO2 monitoring system comprising the following components: communication module, airway sampling adapter, and CO2 module. See Figure 4-6.

The module generates infrared light and beams it through the sample cell to a detector on the opposite side. CO2 from the patient that is aspirated into the sample cell absorbs some of this energy. The system uses a sampling rate of 50 ml/min.

The system determines CO2 concentration in the breathing gases by measuring the amount of light absorbed by these gases.

The ventilator displays CO2 measurements as numeric values, waveforms, trends, and loops.

Figure 4-6. Sidestream CO2 monitoring components and assembly

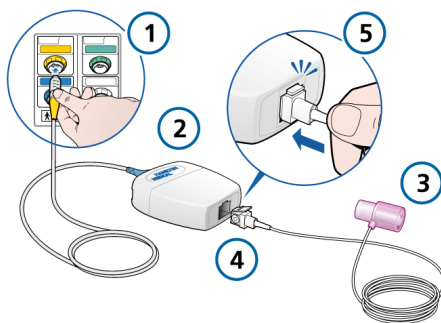

- | | |
|--|--------------------------------------|
| 1 Communications module with CO2 connection port | 4 Sampling cell |
| 2 CO2 module | 5 Connecting sampling cell to module |
| 3 Airway adapter | |

4.5.2.1 Connecting the sidestream CO2 sensor

Before proceeding, review the safety information in Chapter 1.

To set up CO2 sidestream monitoring

1. Connect the CO2 module cable to the CO2 connection port (1) on the ventilator (see Figure 4-6).
2. Insert the sample cell (4) into the CO2 module (2) as shown in Figure 4-6. It clicks into place.

Inserting the sample cell into the module automatically starts the sampling pump. Removing the cell turns the pump off.

3. Perform the zero calibration of the adapter, if necessary, as described in Section 5.4.5 before connecting it to the breathing circuit.
4. Connect the adapter between the inspiratory limb and the flow sensor (or between the inspiratory limb and HMEF, if used). See Figure 4-7.

The sampling line should face away from the patient.

5. Secure the sampling line safely out of the way.

Figure 4-7. Connecting CO2 adapter (1) to the breathing circuit

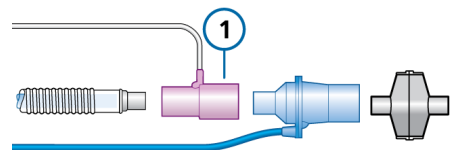

To remove the sample cell

1. Remove the airway adapter from the breathing circuit.
2. Press down on the locking tab and remove the sample cell from the CO2 module.

4.6 Setting up SpO2 monitoring

The HAMILTON-S1 supports input of SpO2 and related pulse oximetry data, and provides integrated monitoring and data display.

Enabling SpO2 measurement on the ventilator requires enabling the SpO2 hardware (in Configuration) and enabling the sensor(s).

Table 4-2. SpO2 measurement overview

For details about ...	See ...
Activating the SpO2 hardware	Section 14.11.3
Installing a module	Section 4.2
Enabling the SpO2 sensor(s)	Section 4.7
Working with SpO2 data	<i>Pulse Oximetry Instructions for Use</i>

4.7 Enabling sensors

Before proceeding, review the safety information in Chapter 1.

In addition to hardware activation for CO2 and SpO2 measurement (Section 14.11.3, the O2, CO2, and/or SpO2 sensors must be individually enabled for monitoring data to be available.

To enable sensor monitoring

1. Open the System > Sensors on/off window.
2. Select the appropriate checkboxes (O2, CO2, SpO2 left, SpO2 right) to enable/disable the monitoring functions, as desired.

The ventilator always enables O2 monitoring upon restart.

Figure 4-8. System > Sensors on/off window

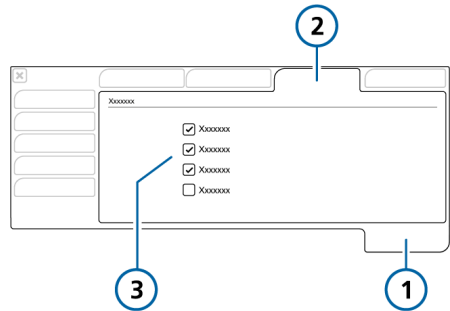

- 1 System
- 2 Sensors on/off
- 3 O2, CO2⁸, SpO2 left⁸, SpO2 right⁸

⁸ If the option is installed and activated.

4.8 Setting up nebulization

The HAMILTON-S1 supports the following nebulizer types:

- Pneumatic
- Aerogen^{5, 9, 10}

This section describes how to connect and set up the nebulizer for use.

Nebulizer and operation details are provided in Section 10.7.

4.8.1 Setting up a pneumatic nebulizer

Setting up and using a pneumatic nebulizer comprises the following steps:

Table 4-3. Nebulizer setup and use overview

To ...	See ...
Enable or disable volume compensation in Configuration. By default, enabled.	Section 14.7
Connect the nebulizer to the breathing circuit and ventilator, and set it up for use.	This section
Configure duration and breath cycle synchronization settings, and start nebulization.	Section 10.7
Information about supported nebulizers and their operation is also provided.	

To connect a pneumatic nebulizer to the breathing circuit set

1. Connect the nebulizer as shown in Figure 4-9.
2. Connect the nebulizer tubing to the ventilator Nebulizer port (Figure 2-3).

Figure 4-9. Connecting a pneumatic nebulizer

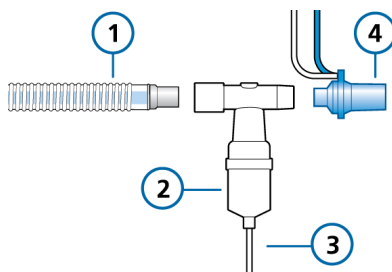

- 1 Breathing circuit (coaxial shown)
- 2 Nebulizer
- 3 Nebulizer tubing to ventilator
- 4 Flow sensor

For additional details, refer to the manufacturer's instructions for use.

⁹ Not available in all markets.

¹⁰ If the option is installed and activated.

4.8.2 Setting up an Aerogen nebulizer

Before proceeding, review the safety information in Chapter 1.

The HAMILTON-S1 supports the use of an Aerogen nebulization system¹¹.

The system comprises the Aerogen module and connection port on the ventilator (Figure 2-3), and the Aerogen Solo or Aerogen Pro nebulizer.

Setting up and using an Aerogen nebulizer comprises the following steps:

To ...	See ...
If not installed, install the Aerogen module.	Section 4.2
In Configuration, enable the Aerogen option.	Section 14.7
Connect Aerogen to the breathing circuit and the ventilator, and set it up for use.	<i>Aerogen Solo/ Aerogen Pro Instructions for Use</i>
Configure duration and breath cycle synchronization settings, and start nebulization.	Section 10.7
Information about supported nebulizers and their operation is also provided.	

4.9 Connecting to an external patient monitor or other device

You can connect the ventilator to a patient monitor, PDMS, computer, or distributed alarm system using the communication ports on the ventilator. For details, see the *Communication Interface User Guide*, available on MyHamilton.

By connecting the ventilator to a distributed alarm system, you can activate global AUDIO OFF for most alarms for an unlimited period of time. For details, see Section 9.5.

¹¹ If the option is activated.

5

Specifying ventilation settings

5.1	Process overview	78
5.2	Selecting the patient group	78
5.3	Entering patient data	79
5.4	Performing the preoperational check, tests, and calibrations	80
5.5	Selecting the ventilation mode	88
5.6	Setting alarm limits	96
5.7	Starting ventilation	98
5.8	Stopping ventilation	98
5.9	About the control parameters	98

5.1 Process overview

This section explains how to set up the HAMILTON-S1 for ventilation on an individual patient.

Setting up ventilation generally comprises the following steps, each of which is described in this chapter:

- Selecting the patient group
- Specifying patient data
- Performing the preoperational check, including:
 - Performing a breathing circuit tightness test
 - Calibrating the flow sensor, O2 sensor, and zero calibration of the CO2 sensor
- Testing alarms
- Selecting the ventilation mode
- Reviewing and adjusting control settings
- Reviewing and adjusting alarm limits

5.2 Selecting the patient group

Before proceeding, review the safety information in Chapter 1.

The HAMILTON-S1 supports the following patient groups: **Adult**, **Pediatric**, and **Neonatal**.

Table 5-1. Patient groups

Adult	Pediatric	Neonatal
Sex: M, F	Sex: M, F	Weight:
Height: 130 to 250 cm	Height: 30 to 150 cm	0.2 to 30 kg
IBW: 30 to 139 kg	IBW: 3 to 42 kg	Minimum delivered tidal volume: 2 ml
Minimum delivered tidal volume: ≥ 100 ml	Minimum delivered tidal volume: 20 ml	

To select the patient group and initial settings

- ▶ For a new patient, touch the desired patient group tab in the Standby window (Figure 5-1):
 - **Adult**
 - **Pediatric**
 - **Neonatal**

Touch **Last patient** to reuse the last active ventilator parameters.

The selected patient group appears under the mode name (Figure 2-6).

The settings saved with the selected patient group are loaded and displayed (Section 5.2.1), in addition to the default patient sex/height/IBW (**Adult/Pediatric**) or weight (**Neonatal**).

Figure 5-1. Standby window

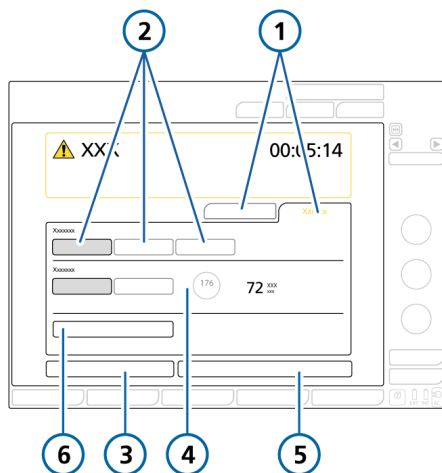

- | | |
|----------------------------------|---|
| 1 New patient, Last patient tabs | 4 Gender/height/IBW (or Weight for Neonatal) for selected default |
| 2 Patient groups | 5 Start (When Hi Flow O2 is selected: Start therapy) |
| 3 Preop check | 6 INTELLiVENT-ASV ¹² |

5.2.1 About system defaults: pre-configured settings

For each of the patient groups, a different default configuration can be defined.

During patient setup, you can then quickly pre-configure the ventilator according to your standard protocols, and modify settings as needed.

Each Default setup defines a ventilation mode, mode control settings, graphic display selection, and O2 enrichment and nebulizer settings.

The Default setups are defined in Configuration (Chapter 14).

5.3 Entering patient data

CAUTION

Entering the correct patient data ensures safe ventilation settings for start up and apnea backup.

Before proceeding, review the safety information in Chapter 1.

Specifying the correct patient data is particularly important, as the ventilator uses this data as a basis for some calculations and initial mode control settings.

- For the **Adult** and **Pediatric** patient groups, the ventilator uses sex and patient height to calculate the ideal body weight (IBW).
- For **Neonatal** patients, the ventilator uses the patient body weight.

To enter patient data

- ▶ In the Standby window:
 - **Adult/Pediatric.** Specify the patient sex and height. The device calculates the patient IBW.
 - **Neonatal.** Specify the patient weight.

¹² Not available in all markets.

5.4 Performing the preoperational check, tests, and calibrations

The tests and calibrations described in this section help verify the safety and reliability of the ventilator.

If a test fails, troubleshoot the ventilator as indicated or have the ventilator serviced. Make sure the tests pass before you return the ventilator to clinical use.

The test results are stored in memory, including when the ventilator is turned off. This allows the ventilator to be checked and kept in storage, ready for use.

The audible alarm is paused during calibration.

Table 5-2. When to perform tests and calibrations

Test or calibration	When to perform
Preoperational check	Before connecting a new patient to the ventilator.
Flow sensor calibration and tightness test	After connecting a new breathing circuit or component (including a flow sensor).
O2 sensor calibration, if needed	After installing a new O2 sensor or when a related alarm occurs. Not required with a paramagnetic O2 sensor.
CO2 sensor/adapter zero calibration (mainstream/sidestream)	Required after connecting a CO2 sensor or when a related alarm occurs. Recommended after switching between different airway adapter types.

Test or calibration	When to perform
Alarm tests	As desired

To access tests and calibration functions

- Do either of the following:
 - Open the System > Tests & calib window.
 - From the Standby window, touch the **Preop check** button.
- Touch the button for the desired operation.

Figure 5-2. System > Tests & calib window

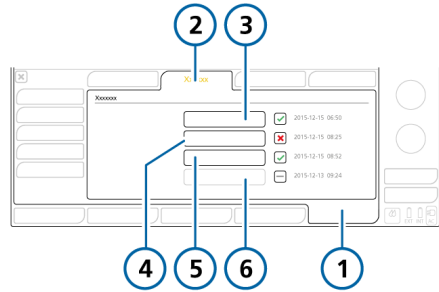

- | | |
|-----------------|----------------------------------|
| 1 System | 4 Tightness (shown uncalibrated) |
| 2 Tests & calib | 5 O2 sensor |
| 3 Flow Sensor | 6 CO2 sensor (shown disabled) |

A checkmark indicates the component is calibrated and ready. A red X indicates the calibration was unsuccessful. A box with no marks indicates the test/calibration has not been performed. A grayed-out box indicates the CO2 sensor is not enabled.

5.4.1 Performing the preoperational check

Before proceeding, review the safety information in Chapter 1.

When to perform

Before connecting a new patient to the ventilator.

To perform the preoperational check

1. Use a setup as described in Table 5-3.
2. Perform all of the steps in Table 5-4.

To ensure that the ventilator functions according to specifications on your patient, we recommend that your test circuit be equivalent to the circuit used for ventilation.

Table 5-3. Test breathing circuit setup

Component	Specification
Breathing circuit	Adult/pediatric, ID10 to ID22
Flow sensor	Adult/pediatric, with calibration adapter
Test lung	Demonstration lung, 2 liter, with adult ET tube between flow sensor and lung

If using heliox, follow the preoperational steps described in Table 5-5.

Table 5-4. Preoperational check

Do or observe...	Verify ...
1 Connect ventilator to primary power and an oxygen supply.	
2 Assemble the patient breathing circuit.	The breathing circuit is assembled correctly.
3 Turn on the ventilator.	During the self test, the alarm lamp is lit red and the buzzer sounds briefly.
4 With the ventilator in Standby, touch Preop check in the Standby window.	The System > Tests & calib window opens.
5 Perform the tightness test.	The test passes. See Section 5.4.2.
6 Calibrate the flow sensor.	The calibration is successful. See Section 5.4.3.
7 If necessary, run the O ₂ sensor calibration.	The calibration is successful. See Section 5.4.4.
8 If necessary, run the CO ₂ sensor zero calibration.	The zero calibration is successful. See Section 5.4.5.
9 Generate test alarms.	The corresponding alarm message is displayed in the message bar. See Section 5.4.6. Note that patient alarms are suppressed in Standby.

Table 5-5. Preoperational check with Heliox

Do or observe...	Verify ...
1 Connect ventilator to primary power, Heliox, compressed air, and oxygen supplies.	
2 Assemble the patient breathing circuit.	Breathing circuit is assembled correctly.
3 Turn on the ventilator.	During the self test, the alarm lamp is lit red and the buzzer sounds briefly.
4 Select Air as the gas source, disconnect the air supply, and generate an Air supply failed alarm.	See Section 5.4.6.1.
5 Select Heliox as the gas source, disconnect the Heliox supply, and generate a Heliox supply failed alarm.	See Section 5.4.6.1.
6 Select the gas source to use for ventilation.	
7 Perform the tightness test.	The test passes. See Section 5.4.2.
8 Calibrate the flow sensor.	The calibration is successful. See Section 5.4.3.
9 If necessary, calibrate the O2 sensor.	The calibration is successful. See Section 5.4.4.
10 If necessary, run the CO2 sensor zero calibration.	The zero calibration is successful. See Section 5.4.5.

Corrective action

A checkmark indicates the component is calibrated and ready. A red **X** indicates the calibration was unsuccessful.

If the ventilator does not pass the preoperational check, have it serviced.

5.4.2 Performing the breathing circuit tightness test

Before proceeding, review the safety information in Chapter 1.

This test checks for leakage in the patient breathing circuit.

When to perform

After installing a new or decontaminated breathing circuit or component (including a flow sensor).

To perform the tightness test

1. Set up the ventilator for ventilation, complete with breathing circuit and flow sensor.
2. In the System > Tests & calib window, touch **Tightness**.

The text **Disconnect patient** is now displayed.

3. Disconnect the breathing circuit at the patient side of the flow sensor. Do not block the open end of the flow sensor.

The text **Tighten patient system** is now displayed.

- Block the opening (wearing a glove is recommended).



The text **Patient system tight** is now displayed.

- Connect the patient.
- When the test is complete, verify that there is a checkmark in the **Tightness** checkbox.

To cancel the test while it is in progress

- Touch **Tightness** again.

In case of test failure

If the test fails, a red **X** is displayed in the **Tightness** checkbox.

Perform the following checks, repeating the tightness test after each one, until the test is successful:

- Check the breathing circuit for a disconnection between the ventilator and the flow sensor, or for other large leaks (for example, breathing circuit, humidifier).
- Check that the flow sensor and expiratory valve set are properly seated.
- If the calibration still fails, replace the flow sensor.
- If the calibration still fails, replace the expiratory valve membrane.
- If the calibration still fails, replace the expiratory valve set.
- If the calibration still fails, replace the breathing circuit.

If the problem still persists, have the ventilator serviced.

5.4.3 Calibrating the adult/pediatric flow sensor

This calibration checks and resets the calibration points specific to the flow sensor in use, and measures circuit resistance compensation.

Ensure you are using the correct flow sensor for the selected patient group. If there is a mismatch, calibration fails.

For details about calibrating a neonatal flow sensor, see Section 6.2.1.

When to perform

After connecting a breathing circuit or component.

To calibrate an adult/pediatric flow sensor

- Set up the ventilator for ventilation, complete with breathing circuit and flow sensor.
- In the System > Tests & calib window, touch **Flow Sensor**.
If you have not already disconnected the patient, the message line displays **Disconnect patient**.
- Disconnect the patient now.

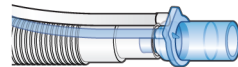

- When prompted, attach the calibration adapter to the flow sensor and flip them 180° so the adapter is

directly connected to the limb (as shown below).

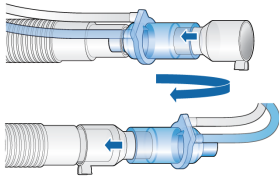

5. When prompted, flip the flow sensor/adapter 180° again, so the flow sensor is directly connected to the limb, and remove the calibration adapter.

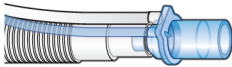

6. When calibration is complete, verify that there is a checkmark in the Flow Sensor checkbox.
7. When successful, continue with other tests or ventilation.

To cancel an ongoing calibration

- ▶ Touch **Flow Sensor** again.

In case of calibration failure

If the calibration fails, a red **X** is displayed in the **Flow Sensor** checkbox.

Perform the following checks, repeating the calibration after each one, until calibration is successful:

- Ensure that the flow sensor is appropriate for the selected patient group.
- Check the breathing circuit for a disconnection between the ventilator and the flow sensor, or for other large leaks (for example, breathing circuit, humidifier).
- Check that the flow sensor and expiratory valve set are properly seated.

- If the calibration still fails, replace the flow sensor.
- If the calibration still fails, replace the expiratory valve membrane.
- If the calibration still fails, replace the expiratory valve set.

If the problem persists, have the ventilator serviced.

5.4.4 Calibrating the O₂ sensor

The device tests the O₂ sensor and resets the calibration points specific to the sensor in use.

The galvanic O₂ sensor requires approximately 30 minutes startup time to reach stable values. O₂ monitoring during this time period may be more variable. We recommend waiting 30 minutes prior to calibrating the O₂ sensor.

The paramagnetic O₂ sensor does not require startup time, and is only calibrated once, upon installation.

To perform O2 sensor calibration

1. Ensure the appropriate gas supplies are connected to the ventilator.
2. In the System > Tests & calib window, touch O2 sensor.
3. When calibration is complete, the message **O2 sensor calibration OK** is displayed. Verify that there is a checkmark in the O2 sensor checkbox.

In case of calibration failure

If the calibration fails, a red **X** is displayed in the O2 sensor checkbox.

Perform the following checks, repeating the calibration after each one, until calibration is successful:

- Ensure a Hamilton Medical O2 sensor is installed.
- If the second calibration attempt fails, and you are using a galvanic O2 sensor, replace the sensor.

If the problem persists, have the ventilator serviced.

5.4.5 Performing a zero calibration on the CO2 sensor/adapter**⚠ CAUTION**

- *Always perform zero calibration with the CO2 sensor (mainstream) or CO2 module (sidestream) connected to the airway adapter.*
- *Be sure NOT to cover both ends of the airway adapter with your fingers.*

Before proceeding, review the safety information in Chapter 1.

The CO2 adapter zero calibration compensates for optical differences between airway adapters and for sensor drift.

Note that the CO2 sensors are calibrated at the factory; you only need to zero the adapters as described below.

Zero calibration requirements for mainstream CO2 sensors

Perform a zero calibration in the following cases:

- With the first use of the sensor
- When changing between airway adapter types (for example, from single use to reusable)
- When the CO2 sensor calibration needed alarm is generated

Zero calibration requirements for sidestream CO2 sensors

You only need to perform a zero calibration with sidestream CO2 sensors when the CO2 sensor calibration needed alarm is generated.

Wait at least 20 seconds — and for best results, 2 minutes — to perform the zero calibration after removing the adapter from the patient's airway. This time allows any CO2 remaining in the adapter to dissipate.

To perform the zero calibration of the CO2 sensor/adapter (mainstream) and sensor/module (sidestream)

For reference, see Figure 4-4 for the mainstream CO2 assembly and Figure 4-6 for the sidestream assembly.

1. Connect the CO2 sensor (mainstream) or the CO2 module (sidestream) to the ventilator, and ensure CO2 monitoring is enabled.

Once connected, wait approximately 90 seconds for the device to warm up.

2. Disconnect the CO2 adapter from the breathing circuit.
3. Attach the CO2 adapter to the sensor (mainstream) or plug the sample cell into the CO2 module (sidestream).

Place these components away from all sources of CO2 (including the patient's and your own exhaled breath) and the exhaust port of the expiratory valve.

4. In the System > Tests & calib window, touch **CO2 sensor**.

Do not move the components during calibration.

5. When the zero calibration is complete, verify that there is a checkmark in the CO2 sensor checkbox.

In case of zero calibration failure

If the zero calibration fails, a red **X** is displayed in the CO2 sensor checkbox.

Perform the following checks, repeating the zero calibration after each one, until it is successful:

- Check the airway adapter and clean if necessary.
- If the zero calibration still fails, ensure there is no source of CO2 near the airway adapter.
- If the zero calibration still fails, connect a new adapter.
- If the zero calibration still fails, connect a new CO2 sensor (mainstream) or CO2 module (sidestream).

If the problem persists, have the ventilator serviced.

5.4.6 Testing the alarms

The HAMILTON-S1 performs a self-check that verifies proper alarm function during startup.

We recommend testing the alarms as part of the preoperational check.

For all of the tests, use a demonstration lung assembly as described in Section 5.4.1.

5.4.6.1 Testing the air and Heliox supply failure alarms

To test the Air supply failure alarm

1. In Standby, open the System > Gas source window, and touch the **Air** button.
2. Disconnect the air supply hose.
3. Start ventilation.
4. Verify that the **Air supply failed** alarm is generated.
5. Return to Standby.

To test the Heliox supply failure alarm

1. In Standby, open the System > Gas source window, and touch the **Heliox** button.
2. Disconnect the heliox supply hose.
3. Start ventilation.
4. Verify that the **Heliox supply failed** alarm is generated.
5. Return to Standby.

5.4.6.2 High pressure alarm test

1. Select the P-CMV mode and start ventilation.
2. Set the **High pressure** alarm limit to 15 cmH₂O above the measured **Ppeak**.
3. Squeeze the demonstration lung hard during inspiration.
4. Verify that the **High pressure** alarm is generated, the ventilator cycles into exhalation, and pressure falls to the PEEP/CPAP level.

5.4.6.3 Low minute volume alarm test

1. Select a mode, for example, P-CMV, and start ventilation.
2. Let the ventilator deliver 10 breaths with no alarms.
3. Adjust the low **ExpMinVol** alarm limit so it is higher than the measured value.
4. Verify that the **Low minute volume** alarm is generated.

5.4.6.4 Low oxygen alarm test

1. Select a mode, for example, P-CMV, and start ventilation.
2. Set the **Oxygen** control to 50%.
3. Wait for two minutes.
4. Disconnect the oxygen supply.
5. Verify the following:
 - The oxygen concentration displayed in the Monitoring window decreases.
 - The **Oxygen supply failed** alarm is generated.
 - The **Low oxygen** alarm is generated.
6. Wait 30 seconds or until the oxygen concentration falls below 40%.
7. Reconnect the oxygen supply.
8. Verify that the **Low oxygen** and **Oxygen supply failed** alarms reset.

The alarm should reset when the measured oxygen exceeds 45%.

5.4.6.5 Disconnection on patient side alarm test

1. Disconnect the demonstration lung during active ventilation.
2. Verify that the **Disconnection on patient side** alarm is generated.
3. Reconnect the demonstration lung.
4. Verify that the alarm resets and that the ventilator automatically resumes ventilation.

5.4.6.6 Loss of external power alarm test

1. With the ventilator connected to primary power, turn it on.
2. Disconnect the power cord.
3. Verify that the **Loss of mains power** alarm is generated and that the ventilator is powered by its backup battery.
4. Reconnect the ventilator to primary power.
5. Verify that the alarm resets and that the ventilator is again powered by primary AC power.

5.4.6.7 Exhalation obstructed alarm test

1. Block the expiratory valve exhaust port during active ventilation.
2. Observe the pressure rise.
3. Verify that the **Exhalation obstructed** alarm is activated.

5.4.6.8 Apnea alarm test

1. Select the SPONT mode.
Make sure Apnea backup ventilation is disabled.
2. Wait for the set apnea time.
3. Verify that the **Apnea** alarm is generated.
4. Squeeze the demonstration lung twice.
5. Verify that the **Apnea** alarm resets.

5.5 Selecting the ventilation mode

The active ventilation mode is displayed at the top right corner of the display together with the selected patient group.

When first starting to ventilate a patient, the mode associated with the default for the patient group is pre-selected. You can change it, if needed.

For details about each of the modes, see Chapter 7.

To select a mode

1. Touch the **Modes** button (1).

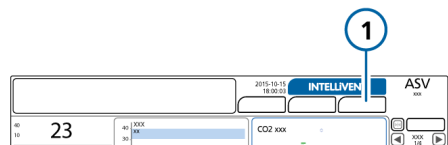

2. In the Modes window, touch the desired mode, then touch **Continue**.
The **Continue** button is only displayed after you select a different mode in the window.
The Controls window opens.
3. Review and, if needed, adjust the control settings (Figure 5-4), then touch **Confirm** to enable the new mode.

The newly selected mode is not active *until* you touch **Confirm** in the Controls window. If you do not touch **Confirm**, the window closes after a short time and the currently active mode remains in place.

Figure 5-3. Modes window, changing modes

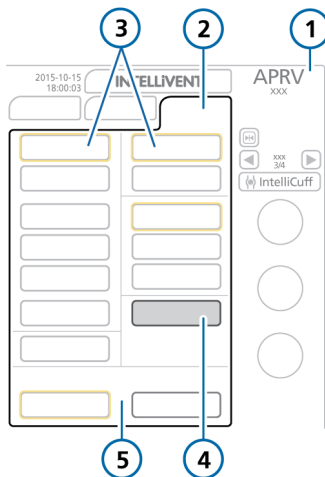

- 1 Active mode, patient group
- 2 Modes
- 3 Backup mode for mode group (framed in yellow)
- 4 New mode
- 5 Cancel/Confirm

Figure 5-4. Controls window, changing modes

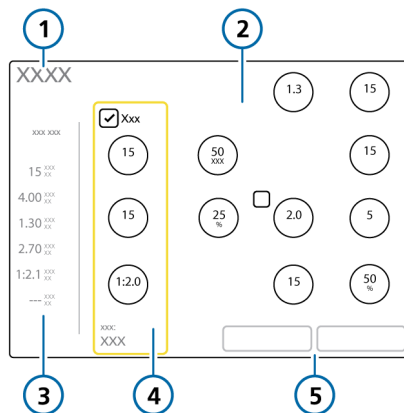

- 1 New mode
- 2 Controls for new mode
- 3 Values depending on mode
- 4 Apnea Backup On/Off and controls (if applicable)
- 5 Cancel/Confirm mode

5.5.1 Reviewing and adjusting ventilation settings

You specify ventilation settings in the Controls and Additions windows. The Patient window provides access to patient data during ventilation.

Which windows are available depends on which mode is selected, as well as whether you are in Standby or active ventilation.

In addition, the Controls window changes slightly depending on whether you are changing settings for the active mode or you are changing modes.

To change the control settings for the active mode

1. Open the Controls window and select and adjust settings as needed. See Figure 5-5. The change takes effect immediately. For details about changing the trigger type, see Section 5.5.2.
2. Open the Additions > Sigh window to enable/disable Sigh, if needed. When Sigh is active, the text Sigh is displayed at the top right corner of the display below the current mode and patient group.
3. If applicable, open the Controls window and select or deselect Backup as needed.
4. If applicable, open the Additions > TRC window and enable/disable/adjust settings as needed. See Section 5.5.4. When TRC is active, the text ET tube or Trach tube is displayed at the top right corner of the display below the current mode and patient group.

5. If you need to change basic patient data, touch **Patient** and adjust settings as needed. See Section 5.3.

Figure 5-5. Controls window, settings for active mode

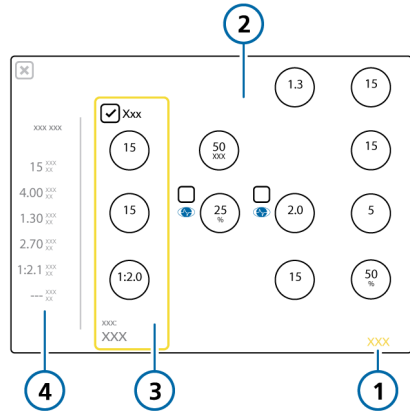

- | | |
|-----------------|--|
| 1 Controls | 3 Apnea Backup On/Off and controls (if applicable) |
| 2 Mode controls | 4 Values depending on mode (Rate, I:E, Ttotal, TI, TE, Pause, IRV) |

5.5.2 About the trigger types

Before proceeding, review the safety information in Chapter 1.

You can select the conditions that cause the ventilator to trigger inspiration based on flow, pressure, or using the IntelliSync+ trigger¹³ (Section 5.5.2.1).



In addition, you can select the conditions that cause the ventilator to trigger expiration based on flow or using the IntelliSync+ trigger¹³ (Section 5.5.2.2).

¹³ If the IntelliSync+ option is installed.

5.5.2.1 Selecting the inspiratory trigger type

You can select the inspiratory trigger type to use. Table 5-6 describes the trigger types, how they are displayed, and their behavior.

Table 5-6. Inspiratory trigger types

Trigger type and indicator	Description
Flow trigger 	The patient's inspiratory flow triggers the ventilator to deliver a breath.
Pressure trigger 	The drop in airway pressure when the patient tries to inhale triggers the ventilator to deliver a breath.
IntelliSync+ ^{13, 14} 	<i>Adult/Pediatric patients only.</i> The ventilator monitors incoming sensor signals from the patient and reacts dynamically to initiate inspiration in real time.
Trigger off	This setting prevents the ventilator from recognizing a patient trigger in (S)CMV, P-CMV, and APVcmv modes.

⚠ WARNING! Never select Trigger off for spontaneously breathing patients without sound clinical reasons, as this can affect patient-ventilator synchrony.

To specify the inspiratory trigger type and setting

1. In the Controls window, touch the box to the left of the **Trigger** control to change between the trigger types.
2. Adjust the **Trigger** setting as needed.
If IntelliSync+ is selected, the control shows the text, **IntelliSync+**, indicating that the ventilator dynamically adjusts the setting in real-time.

Note the following:

- Changing the setting during the inspiratory phase affects the next breath. Changing it during the expiratory phase affects the breath after the next breath.
- If the trigger is set higher than the patient's efforts can achieve, a breath cannot be triggered. Reset the trigger to an achievable value, adjusting the sensitivity of the trigger to the patient's ability.

¹⁴ Not available in all markets.

Figure 5-6. Inspiratory and expiratory trigger controls

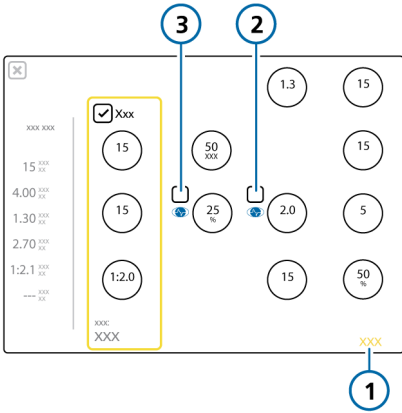

- 1 Controls
- 2 Inspiratory trigger selection box
- 3 Expiratory trigger selection box

5.5.2.2 Selecting the expiratory trigger type

You can select the expiratory trigger type to use. Table 5-7 describes the options and behavior.¹⁵

Table 5-7. Expiratory trigger types

Trigger type	Description
ETS	The percent of peak inspiratory flow at which the ventilator cycles from inspiration to exhalation.
IntelliSync+	<i>Adult/Pediatric patients only.</i> The ventilator monitors incoming sensor signals from the patient and reacts dynamically to initiate expiration in real time.

To specify the expiratory trigger type and setting

- In the Controls window, touch the box to the left of the ETS control to change between the trigger types.
- If ETS is selected, adjust the ETS setting as needed.

If IntelliSync+ is selected, the control shows the text, **IntelliSync+**, indicating that the ventilator dynamically adjusts the setting in real-time.

5.5.2.3 About IntelliSync+ indicators on the ventilator

The IntelliSync+ symbol in the Controls window indicates whether the option is installed on the device, and whether it is active.



The icon is grayed out if IntelliSync+ is not installed on your device.

When active, the IntelliSync+ symbol is also shown on the uppermost waveform on the display.

Additional symbols are shown on the waveform, indicating the patient trigger and inspiratory time, depending on whether IntelliSync+ is selected as the inspiratory and/or expiratory trigger (Figure 5-7).

¹⁵ If the IntelliSync+ option is installed.

Figure 5-7. IntelliSync+ symbols on the waveform

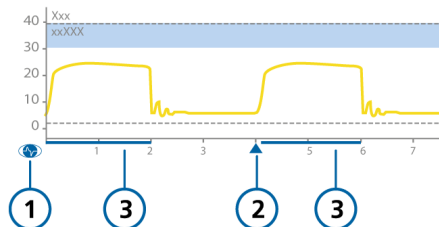

- 1 IntelliSync+ symbol
- 3 Blue bar indicating inspiratory time**

2 Blue patient inspiratory trigger symbol*

* When IntelliSync+ is selected as the inspiratory trigger.

** When IntelliSync+ is selected as the expiratory trigger.

5.5.3 About apnea backup ventilation

Before proceeding, review the safety information in Chapter 1.

The HAMILTON-S1 provides apnea backup ventilation, a mechanism that minimizes possible patient injury due to apnea or cessation of respiration. Apnea backup is available in APVsimv, SIMV, P-SIMV, SPONT, DuoPAP, APRV, VS, and NIV modes.

Apnea backup ventilation enabled

Apnea backup provides ventilation after the apnea time passes with no breath attempts detected. The apnea time is set in the Alarms window using the Apnea time control.

When this occurs, the ventilator automatically and immediately switches into apnea backup ventilation.

It generates a low-priority alarm, displays the alarm **Apnea ventilation**, and provides ventilation using the settings specified in Section 7.1.3.

When Backup is enabled, the control setting for the Apnea backup mode depends on the IBW (or weight for neonates) of the patient.

To change the Apnea backup control settings

1. In the Controls window, select the Backup checkbox. The settings controls are enabled.
2. Change the values as desired. The changes take effect immediately.

Figure 5-8. Controls window, Apnea controls

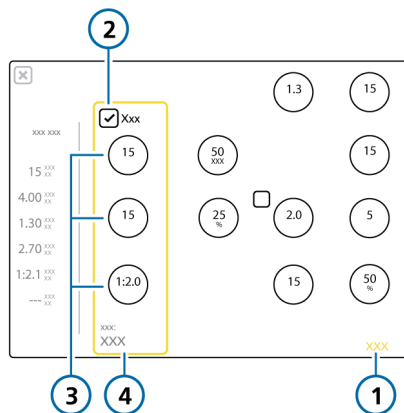

- 1 Controls
- 2 Backup enabled/disabled check box
- 3 Control settings corresponding to the mode
- 4 Backup mode

If the patient triggers two consecutive breaths, the ventilator reverts to ventilation in the original support mode and at the original settings, and displays the message, *Apnea ventilation ended*.

Once Apnea backup ventilation is enabled or disabled, it retains this status in all applicable modes. Apnea backup ventilation requires no clinician intervention, although you can freely change the mode during Apnea backup ventilation, either switching to a new mode or accepting the backup mode as the new mode.

Apnea backup ventilation disabled

When Apnea backup is disabled, the high-priority Apnea alarm is generated when apnea occurs and there is no patient trigger within the operator-set interval.

5.5.4 About tube resistance compensation (TRC)

Before proceeding, review the safety information in Chapter 1.

TRC is intended for use with spontaneously breathing patients.

Tube resistance compensation (TRC) is flow-proportional pressure support to compensate the flow resistance of the ventilation tube (endotracheal (ET) or tracheostomy (Trach)).

100% compensation indicates that resistance due to the tube itself is compensated. Note that internal resistance (for example, from secretions) and external resistance (for example, from tube kinking) are not compensated.

TRC can be enabled or disabled for the expiration phase, as well.

By default, TRC is disabled.

When TRC is enabled:

- The additional work of breathing due to the tube can be partially or completely compensated.
- The tracheal pressure (P_{trach}) waveform (orange) is shown together with the Paw waveform (yellow).
- At the beginning of the inspiratory phase, the pressure will be higher than without TRC, and will drop below PEEP at the beginning of the exhalation phase to compensate the flow-dependent resistance. See Figure 5-9 for an example.
- The displayed P_{peak} may be higher than the set PEEP/CPAP plus $P_{control}$ / $P_{support}$ due to the additional pressure required to work against the tube resistance.

Figure 5-9. $P_{trachea}$ (orange) and Paw (yellow) waveforms, with TRC active

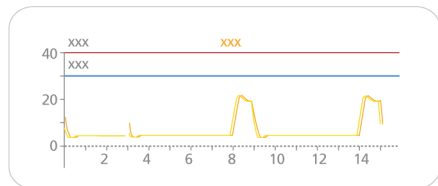

The Ptrachea waveform is calculated as follows:

$$\Delta P_{ETT} = K_{tube} \times \dot{V}$$

where

ΔP_{ETT} Flow-proportional pressure drop over the tube. This is the difference between the Ptrachea and Paw waveforms.

K_{tube} Tube coefficient (k-factor). Dependent on inner diameter and length of tube, is equal to flow/resistance at a flow of 1 l/s.

\dot{V} Flow of the breathing gas.

To specify TRC settings

1. Touch **Additions > TRC**.
2. In the TRC window (Figure 5-10), touch the **ET tube** button to set the ET tube compensation settings. To set the tracheostomy tube compensation settings, touch the **Trach tube** button.
3. Using the **Tube size** and **Compensate** controls, specify the tube diameter (in mm) and compensation percentage (%) to apply (Figure 5-10). If the tube is shortened, reduce the compensation percentage.
4. To disable TRC if it has been enabled, touch **Disable TRC**.
5. Touch **Confirm** to apply the settings.

Figure 5-10. Additions > TRC window

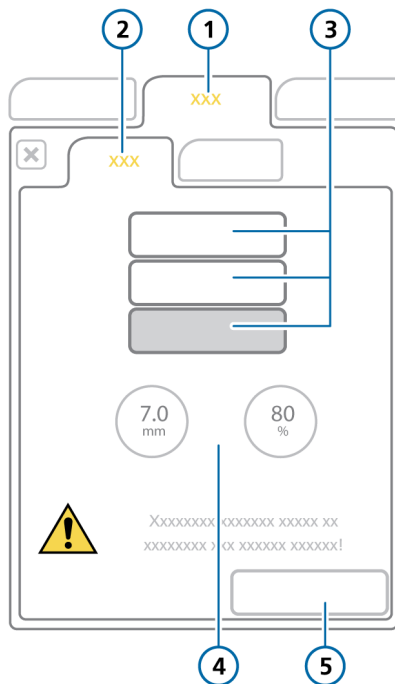

- | | |
|----------------------------------|--|
| 1 Additions | 4 Tube size (I.D.) and Compensate controls |
| 2 TRC | 5 Confirm |
| 3 ET and Trach tube, Disable TRC | |

5.6 Setting alarm limits

Before proceeding, review the safety information in Chapter 1.

You can access the Alarms window and change alarm settings at any time, without affecting ventilation.

Figure 5-11. Alarms > Limits 1 window

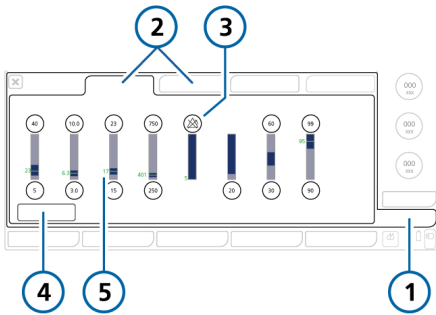

- | | |
|--|---------------------------|
| 1 Alarms | 4 Auto |
| 2 Limits 1, 2 | 5 Current monitored value |
| 3 Alarm Off symbol when an alarm limit is set to Off | |

To review and adjust alarms

1. Either touch the **Alarms** button.
The Alarms > Limits 1 window is displayed (Figure 5-11).
2. To set an alarm limit individually, touch the alarm control and adjust the value. Repeat for any other alarm.

Additional alarm settings are available, if used, in the Limits 2 window.

Note that when an alarm limit is set to **Off**, the device displays the Alarm Off symbol.

3. To set alarm limits automatically, touch the **Auto** button in the Limits 1 window.

Selecting **Auto** automatically sets alarm limits around the current monitoring parameter values except for the **Apnea time** alarm limit¹⁶. The **Apnea time** alarm must be set manually to the desired level.

Note that some automatic settings are not appropriate under all clinical conditions. Check the validity of the settings as soon as possible.

4. Close the window.

The following table briefly describes each of the adjustable ventilator alarms. Additional details are available in Table 16-9.

For SpO₂-related alarms, see the *Pulse Oximetry Instructions for use*.

¹⁶ SpO₂-related alarms are also not automatically set.

Table 5-8. Adjustable alarms

Alarm	Definition
Apnea time	<p>The maximum time allowed from the beginning of one inspiration to the beginning of the next inspiration.</p> <p>If the patient does not trigger a breath during this time:</p> <ul style="list-style-type: none"> • A low-priority alarm sounds if Apnea backup is enabled. Apnea ventilation begins. • A high-priority alarm sounds if Apnea backup is disabled <p>The Apnea alarm can be turned off in nCPAP-PS mode.</p>
ExpMinVol (low and high)	<p>Low and high expiratory minute volume. If either limit is reached, a high-priority alarm is generated.</p> <p>In nCPAP-PS, the ExpMinVol low/high alarms can be turned off.</p>
Leak	<p>High leakage. Leak is the percentage of delivered inspiratory volume that is not returned during exhalation on the patient side of the flow sensor.</p>
PetCO ₂ (low and high)	<p>Low and high monitored PetCO₂. If either limit is reached, a medium-priority alarm is generated.</p>
Pressure (low and high)	<p>Low and high monitored pressure at the patient airway (P_{peak}). If the high Pressure limit is reached or the device fails to reach the low Pressure limit, a high-priority alarm is generated.</p> <p>When pressure reaches the high pressure limit minus 10 cmH₂O, pressure is limited to this setting; the pressure is not increased further.</p> <p>If the delivered pressure is the same as the set high Pressure alarm limit, the device aborts the breath and reduces the pressure to PEEP level.</p> <p>Sigh breaths are an exception to this rule. In this case, the ventilator may apply inspiratory pressure 3 cmH₂O below the high Pressure alarm limit.</p>
Rate (low and high)	<p>Low and high monitored total breath rate (f_{Total}), including both spontaneous and mandatory breaths. If either limit is reached, a medium-priority alarm is generated.</p>
Vt (low and high)	<p>Low and high expiratory tidal volume, for two consecutive breaths. If either limit is reached, a medium-priority alarm is generated.</p>

5.7 Starting ventilation

Before starting ventilation, review the patient information in the Standby window and ensure it is correct.

To start ventilation

- ▶ Do either of the following:
 - In Standby, press the **Standby** key.
 - In Standby, touch **Start**.
 - Using the P&T knob, move the cursor to the **Start** button, and press the P&T knob.
- If the mode selected is Hi Flow O2, the button is labeled **Start therapy**.

Ventilation starts.

During active ventilation, the Standby key light is white.

5.8 Stopping ventilation

To enter Standby and stop ventilation

1. Press the **Standby** key.
2. In the confirmation window, touch **Activate standby**.

The device enters Standby (Figure 5-1). The yellow counter shows the time elapsed in Standby.

5.9 About the control parameters

Table 5-9 briefly describes each of the ventilator control parameters.

Table 16-5 provides the control parameter ranges and default settings, including accuracy.

Table 5-9. Control parameters, defined

Parameter	Definition
%MinVol	Percentage of minute volume to be delivered in ASV mode. The ventilator uses the %MinVol, Patient height, and sex settings to calculate the target minute ventilation.
%TI	Inspiratory time, the length of time to deliver gas for inspiration at the Pcontrol setting as a percentage of the total breath cycle. Used with Rate to set the breath cycle time.
Apnea backup	A function that provides ventilation after the adjustable apnea time passes without breath attempts. If Automatic is enabled, control parameters are calculated based on the patient's IBW. Applies in APVsimv, SIMV, P-SIMV, SPONT, DuoPAP, APRV, VS, and NIV modes. <i>Be sure to review the safety information in Chapter 1.</i>
ETS	See Trigger, expiratory.
Flow trigger	See Trigger.
Flow	In Hi Flow O2, Flow is the continuous and constant flow of medical gas to the patient in liters per minute.
FlowPattern	Flow pattern for gas delivery. This is not affected by patient pressure or other limitations as long as the peak inspiratory flow or pressure limit is not exceeded. Applies to volume-controlled mandatory breaths.
Gender	Sex of patient. Used to compute ideal body weight (IBW) for adults and pediatric patients.
HAMILTON-H900-related parameters	Displayed when a HAMILTON-H900 humidifier is connected. See Section 12.1.7.
I:E	Ratio of inspiratory time to expiratory time. Applies to mandatory breaths, and in APVcmv, (S)CMV, and P-CMV.
IntelliCuff-related parameters	Displayed when an IntelliCuff cuff pressure controller is connected. See Section 12.2.7.
Oxygen	Oxygen concentration to be delivered. Applies to all breaths.

Parameter	Definition
P ASV limit	<p>The maximum pressure to apply in ASV mode.</p> <p>For the ASV controller to function correctly, P ASV limit must be at least 15 cmH₂O above PEEP/CPAP.</p> <p>Changing P ASV limit or the Pressure alarm limit automatically changes the other: The Pressure alarm limit is always 10 cmH₂O greater than P ASV limit.</p>
P high	The high pressure setting in APRV and DuoPAP modes. Absolute pressure, including PEEP.
P low	The low pressure setting in APRV.
Patient height	Patient height. It determines the ideal body weight (IBW), used in calculations for ASV and ventilation settings for adult/pediatric patients.
Pause	<p>Inspiratory pause or plateau, as a percentage of total breath cycle time.</p> <p>After the required gas is delivered (after the operator-set V_t is reached), gas remains in the lungs and exhalation is blocked during the Pause time. The use of a pause increases the residence time of gas in the patient's lungs.</p> <p>Applies to volume-controlled mandatory breaths, when the device is configured in this manner (Section 14.3.2).</p>
Pcontrol	The pressure (additional to PEEP/CPAP) to apply during the inspiratory phase in P-CMV and P-SIMV modes.
Peak flow	<p>Peak (maximum) inspiratory flow.</p> <p>Applies to volume-controlled mandatory breaths, when the device is configured in this manner (Section 14.3.2).</p>
PEEP/CPAP	<p>Positive end expiratory pressure and continuous positive airway pressure, baseline pressures applied during the expiratory phase.</p> <p>Applies to all breaths, except in APRV and with Hi Flow O₂.</p>

Parameter	Definition
P-ramp	<p>Pressure ramp. The rate at which pressure rises to meet the set value. The set Pressure is generally reached after approximately 2 x P-ramp.</p> <p>The P-ramp setting lets you fine-tune the initial flow output during a pressure-controlled or pressure-supported breath to match the ventilator flow to the patient's demand. Applies to all breaths.</p> <p>Notes:</p> <ul style="list-style-type: none"> • Short P-ramp settings (0 to 50 ms) provide higher initial flow rates and result in faster attainment of the target pressure. This may benefit patients with elevated respiratory drive. • Lower P-ramp values have been correlated with reduced work of breathing in certain patients. • Setting the P-ramp too low, especially in combination with a small ET tube (high resistance), may result in a noticeable pressure overshoot during the early stage of inspiration. • Setting the P-ramp too high may prevent the ventilator from attaining the set inspiratory pressure. A square (rectangular) pressure profile is the goal.
Psupport	<p>Pressure support for spontaneous breaths. It is the pressure (additional to PEEP/CPAP) to apply during the inspiratory phase.</p> <p>Pressure support helps the patient counteract the flow resistance of the breathing circuit and endotracheal tube. It compensates for the decreasing tidal volume and rising respiratory rate of a spontaneously breathing patient.</p>
P-trigger	See Trigger, inspiratory.
Rate	Respiratory frequency or number of breaths per minute.
Sigh	<p>When Sigh is activated, every 50th breath is applied using one of the following settings:</p> <ul style="list-style-type: none"> • In pressure-controlled modes, the pressure delivered is > 10 cmH₂O above the currently set Pcontrol or P_{insp}. • In volume-controlled modes, the tidal volume delivered is 150% of the current tidal volume (V_t) setting. <p>During sigh breaths, the Pressure and V_t alarm limits remain in effect to help protect the patient from excessive pressures and volumes.</p> <p>Not available in DuoPAP, APRV, or Hi Flow O₂ modes.</p>
T high	Length of time at the higher pressure level, P high, in DuoPAP and APRV modes.
T low	Length of time at the lower pressure level, P low, in APRV mode.

Parameter	Definition
TI max	<p>Maximum inspiratory time for cycled breaths in NIV, NIV-ST, and SPONT in neonatal modes, as well as the neonatal mode, nCPAP-PS.</p> <p>For all patient groups, the switchover from inspiration to exhalation in spontaneous breaths is normally controlled by the ETS (expiratory trigger sensitivity). If gas leakage is significant, however, the set cycle may never be reached. The TI max setting provides a backup so inspiration can be terminated. The ventilator switches over to exhalation when the set TI max is reached.</p>
TI	Inspiratory time, the length of time to deliver gas for inspiration at the Pcontrol setting. Used with Rate to set the breath cycle time.
Tip	<p>Inspiratory pause or plateau time.</p> <p>After the required gas is delivered (after the operator-set Vt is reached), gas remains in the lungs and exhalation is blocked during the Tip time.</p> <p>The use of an inspiratory pause increases the residence time of gas in the patient's lungs.</p> <p>Applies to volume-controlled mandatory breaths, when the device is configured in this manner (Section 14.3.2).</p>
TRC: Compensate	Compensation percentage (%).
TRC: Tube size (I.D.)	Inner diameter of the tube, in mm.
TRC: Tube type/ Disable TRC	Options are: ET (endotracheal) tube, Trach (tracheostomy) tube, Disable TRC (TRC off)
TRC-related settings	<p>Tube resistance compensation. Reduces the patient's work of breathing by offsetting tube resistance.</p> <p><i>Review the safety information in Chapter 1.</i></p>
Trigger, expiratory	<p>ETS</p> <p>ETS (expiratory trigger sensitivity) is the percent of peak inspiratory flow at which the ventilator cycles from inspiration to exhalation.</p> <p>Increasing the ETS setting results in a shorter inspiratory time, which may be beneficial in patients with obstructive lung disease. The ETS setting lets you match the inspiratory time of pressure-supported breaths to the patient's neural timing.</p>
Trigger, expiratory	<p>IntelliSync+</p> <p>With IntelliSync+, the ventilator monitors incoming sensor signals from the patient and reacts dynamically to initiate inspiration and expiration in real time.</p> <p>Applies to spontaneous breaths.</p>

Parameter	Definition
Trigger, expiratory	The ventilator offers the following cycling options: ETS and IntelliSync+ ^{17, 18} , which apply to all breaths. For details on selecting the trigger to use, see Section 5.5.2.2.
Trigger, inspiratory	<p>The ventilator offers the following trigger types: Flow, Pressure, and IntelliSync+¹⁷, which apply to all breaths. For details on selecting the trigger to use, see Section 5.5.2.</p> <p>If the trigger is set higher than the patient is able to meet, a breath cannot be triggered. Reset the trigger to an achievable value, adjusting the sensitivity of the trigger to the patient's ability.</p>
Trigger, inspiratory	<p>Flow</p> <p>The patient's inspiratory flow that triggers the ventilator to deliver a breath.</p>
Trigger, inspiratory	<p>IntelliSync+</p> <p>With IntelliSync+, the ventilator monitors incoming sensor signals from the patient and, using a comprehensive set of algorithms, analyzes this data and dynamically adjusts the setting in real-time to address changing patient or system conditions.</p>
Trigger, inspiratory	<p>Pressure</p> <p>The drop in airway pressure when the patient tries to inhale triggers the ventilator to deliver a breath.</p> <p>Changing the setting during the:</p> <ul style="list-style-type: none"> • <i>Inspiratory phase</i> affects the next breath • <i>Expiratory phase</i> affects the breath after next
Trigger, inspiratory	<p>Trigger off</p> <p>This setting prevents the ventilator from recognizing a patient trigger in (S)CMV, P-CMV, and APVcmv modes.</p> <p>⚠ WARNING! Never select Trigger off for spontaneously breathing patients without sound clinical reasons, as this can affect patient-ventilator synchrony.</p>
V limit	Volume limit to be applied during neonatal ventilation in APVcmv, APVsimv, and VS modes.
Vt/IBW Vt/Wt	Tidal volume per weight.

¹⁷ If the IntelliSync+ option is installed.

¹⁸ Not available in all markets.

Parameter	Definition
V _{target}	Target tidal volume to be delivered during inspiration. The device meets V _{target} by adjusting the inspiratory pressure by 1 cmH ₂ O per breath. Applies to breaths in APV _{cmv} , APV _{simv} , and VS modes.
V _t	Tidal volume delivered during inspiration in (S)CMV and SIMV modes.
Weight	Actual body weight. Used only with neonates.

6

Specifying neonatal settings

6.1	Setting up for neonatal ventilation	106
6.2	Performing the preoperational check, tests, and calibrations	109
6.3	Selecting the ventilation mode	111
6.4	Setting the patient weight for ventilation	111
6.5	Alarms for neonatal ventilation	112
6.6	O2 enrichment for neonates	112
6.7	Specifying volume limitation for neonates	112

6.1 Setting up for neonatal ventilation

Before proceeding, review the safety information in Chapter 1.

Setting up for neonatal ventilation comprises the following steps:

To ...	See ...
On the ventilator, select the patient group and specify weight.	Section 6.1.1
Install the expiratory valve.	Section 3.4.2
Select and assemble the appropriate breathing circuit and components.	Section 6.1.2
Adjust the position of the breathing circuit.	Section 6.1.2.5
Connect external devices.	Chapter 4
Perform the preoperational check and any required tests and calibrations.	Sections 6.2 and 5.4
Select the ventilation mode.	Sections 6.3 and 5.5

6.1.1 Setting the patient group and weight

You select the patient group and weight in the Standby window when first setting up the ventilator for the patient.

You can edit this information during ventilation, if needed, in the Patient window.

Figure 6-1. Neonatal Standby window

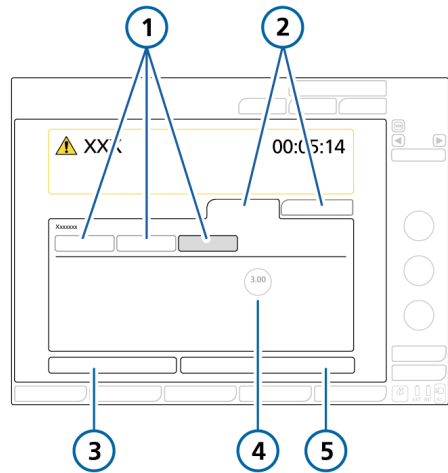

- | | |
|--|--|
| 1 Patient group tabs (Neonatal selected) | 4 Weight |
| 2 New patient, Last patient tabs | 5 Start (when Hi Flow O2 is selected: Start therapy) |
| 3 Preop check | |

To select the patient group

1. In the Standby window, touch the **Neonatal** tab. See Figure 6-1.
The default settings saved with the patient group are loaded and displayed.
2. Touch the **Weight** control and set the patient's body weight.
By default, the weight is set to 2 kg.

You can now select the ventilation mode, if the desired mode is not already selected.

6.1.2 Setting up the patient breathing circuit

Setting up a neonatal breathing circuit comprises the following steps:

Table 6-1. Assembling the breathing circuit

To ...	See ...
Select the components	Section 6.1.2.1
Connect the breathing circuit	Section 6.1.2.2
Connect the flow sensor	Section 6.1.2.4
Position the circuit	Section 6.1.2.5

6.1.2.1 Selecting the breathing circuit components

Select the correct breathing circuit and components for your patient from Table 6-2.

Table 6-2. Neonatal breathing circuit part specifications

Patient group/component	Specification
Patient group	Neonatal
Weight (kg)	0.2 to 30
Tracheal tube ID (mm)	≤ 4
Breathing circuit tube ID (mm)	10 to 12
Flow sensor	Neonatal
CO2 airway adapter	Neonatal

6.1.2.2 Connecting the neonatal breathing circuit

Figures 2-9 through 2-11 in Chapter 2 show typical neonatal breathing circuit configurations.

6.1.2.3 Working with the expiratory valve

The process is the same as for adult and pediatric patients. See Section 3.4.2.

6.1.2.4 Connecting the neonatal flow sensor

Use a Hamilton Medical neonatal flow sensor to ventilate your neonatal patient. Do not use an adult/pediatric flow sensor. Note that the neonatal flow sensor adds 1.3 ml of dead space.

During calibration, the flow sensor is *always* placed after the Y-piece, regardless of which ventilator mode is selected.

To connect the neonatal flow sensor

1. For all modes except nCPAP-PS and Hi Flow O2, connect a flow sensor between the Y-piece of the breathing circuit and the patient connection. See Figure 6-2.

When using the nCPAP-PS mode, connect the flow sensor between the end of the expiratory limb and the expiratory valve on the ventilator (Figure 6-3).

Note that during calibration you place the flow sensor proximal to the patient.

High flow oxygen therapy does not use a flow sensor.

2. Connect the blue and clear tubes to the flow sensor connection ports on the ventilator. The blue tube attaches to the blue connection port. The clear tube attaches to the silver connection port.
3. Calibrate the flow sensor and perform the tightness test. See Section 6.2.

Figure 6-2. Connect flow sensor between the Y-piece and patient interface

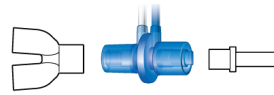
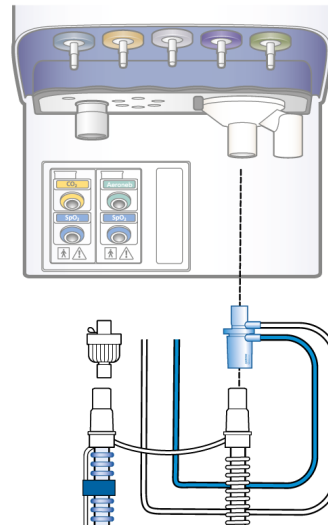

Figure 6-3. Connecting the flow sensor to the expiratory valve, nCPAP-PS mode



6.1.2.5 Positioning the breathing circuit

After assembly, position the breathing circuit so that the hoses will not be pushed, pulled, or kinked as a result of a patient's movement, transport, or other activities, including scanner bed operation and nebulization.

6.2 Performing the preoperational check, tests, and calibrations

Before proceeding, review the safety information in Chapter 1.

The following sections in this chapter provide information that is specific to neonatal ventilation, and is intended as a supplement to the information provided in Chapter 5.

For details about when to perform the tests, and about the full preoperational check process, see Section 5.4.

When to perform

Before connecting a new patient to the ventilator.

To perform the preoperational check

1. Use a setup as described in Table 5-3.
2. Perform all of the steps in Table 5-4.

To ensure that the ventilator functions according to specifications on your patient, we recommend that your test circuit be equivalent to the circuit used for ventilation.

Table 6-3. Test breathing circuit setup

Component	Specification
Breathing circuit	Neonatal, ID10 to ID12
Flow sensor	Neonatal, with calibration adapter
Test lung	Neonatal, with neonatal ET tube between flow sensor and lung model (an IngMar neonatal lung model is recommended)

Table 6-4. Preoperational check, overview

To ...	See ...
Perform the preoperational check.	Section 5.4 in Chapter 5
Perform the tightness test.	Section 5.4.2 in Chapter 5
Calibrate the neonatal flow sensor.	Section 6.2.1
Perform other calibrations, as needed.	Section 5.4 in Chapter 5

6.2.1 Calibrating the neonatal flow sensor

Calibrate the flow sensor after connecting a new flow sensor or whenever the Flow sensor calibration needed alarm is generated.

During calibration, the flow sensor is *always* placed after the Y-piece, regardless of which ventilator mode is selected.

A flow sensor is required for all modes except Hi Flow O2 mode. Before proceeding, ensure you have the calibration adapter available.

To calibrate a neonatal flow sensor

1. Set up the ventilator for ventilation, complete with breathing circuit and flow sensor.
2. Make sure that the Neonatal patient group is selected, a neonatal flow sensor is connected, and the calibration adapter is available.
3. In the System > Tests & calib window, touch **Flow Sensor**.
If you have not already disconnected the patient, the message line displays Disconnect patient.
4. Disconnect the patient now.

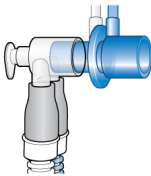

5. When prompted on the display, attach the calibration adapter to the patient end of the flow sensor.

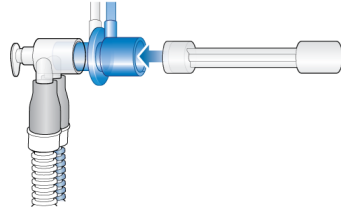

6. When prompted, flip the flow sensor/calibration adapter 180° so the adapter is directly connected to the Y-piece (as shown below).

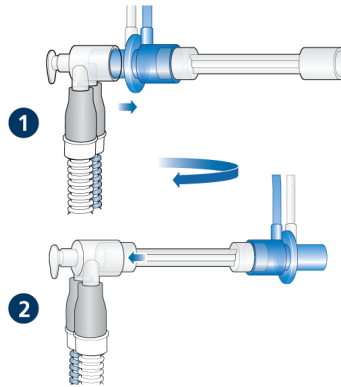

7. When prompted to turn the flow sensor again, remove the calibration adapter, and flip the flow sensor 180° back to its starting position.

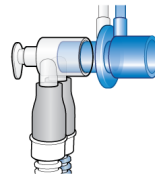

8. When calibration is complete, verify that there is a checkmark in the Flow Sensor checkbox.

9. When successful, continue with other tests or ventilation.

In case of calibration failure

If the calibration fails, a red **X** is displayed in the **Flow Sensor** checkbox.

Perform the following checks, repeating the calibration after each one, until calibration is successful:

- Ensure that the flow sensor is appropriate for the selected patient group.
- Check the breathing circuit for a disconnection between the ventilator and the flow sensor, or for other large leaks (for example, breathing circuit, humidifier).
- Check that the correct flow sensor is connected, and that the flow sensor and expiratory valve/membrane are properly seated.
- If the calibration still fails, replace the flow sensor.
- If the calibration still fails, replace the expiratory valve membrane.
- If the calibration still fails, replace the expiratory valve set.

If the problem persists, have the ventilator serviced.

6.3 Selecting the ventilation mode

The neonatal modes available on the ventilator are either pressure controlled or adaptive (pressure regulated and volume targeted) modes.

Note that the ventilator generates a continuous and constant base flow from the inspiratory outlet to the expiratory outlet during the later part of exhalation.

For the list of supported modes and details about each one, see Chapter 7.

To select the ventilation mode

- ▶ See Section 5.5.

6.4 Setting the patient weight for ventilation

For neonates, the ventilator uses actual body weight (instead of a calculated **IBW**), set in the **Weight** control.

Specifying the correct weight is particularly important as the ventilator uses this data as the basis for some calculations and mode control settings. By default, neonatal weight is set to 3 kg.

To set up the patient, see Section 6.1.1.

6.5 Alarms for neonatal ventilation

Note that the following adjustable alarms use patient weight to set the initial alarm limits:

- Tidal volume, high and low (Vt)
- Minute volume, high and low (ExpMin-Vol)

Be sure to set the correct patient weight in the Standby window before starting ventilation. See Section 6.1.1.

6.6 O2 enrichment for neonates

The applied oxygen concentration during the enrichment maneuver is increased by 25% of the last oxygen setting.

When adjustable O2 enrichment is available, the applied oxygen concentration can be set in the System > O2 enrichment window.

For additional details on performing O2 enrichment, see Chapter 10.

6.7 Specifying volume limitation for neonates

You can specify the volume limitation¹⁹, V limit, during neonatal ventilation in APVcmv, APVsimv, and VS modes. This control is not available for adult and pediatric patients.

Set V limit within the following range:

Table 6-5. V limit allowable range

Minimum	110% of Vtarget or Vtarget + 2 ml, whichever is greater
Maximum	200% of Vtarget

Setting V limit outside of this range generates the Check volume limit alarm (Table 9-2).

Note that when you adjust Vtarget, V limit is automatically readjusted to the default value (150% of Vtarget) and the ventilator displays the message Volume limit changed.

To change the volume limit setting

1. Open the Controls window.
2. Touch **V limit** and adjust the control.

The specified setting is applied immediately.

Figure 6-4. Controls window, V limit

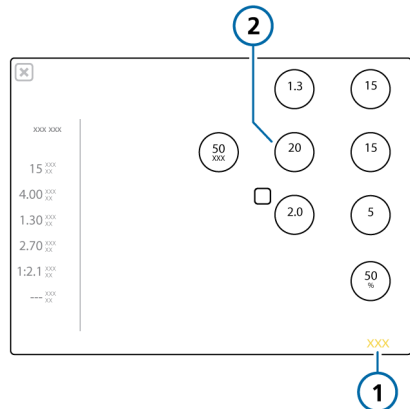

1 Controls

2 V limit

¹⁹ Not available in all markets.

7

Ventilation modes

7.1	Overview.....	114
7.2	Volume-controlled modes, flow control.....	118
7.3	Volume-controlled modes, flow cycled.....	120
7.4	Volume-targeted modes, adaptive pressure control.....	122
7.5	Pressure-controlled modes.....	126
7.6	Intelligent Ventilation.....	131
7.7	Noninvasive modes.....	134
7.8	Ambient state.....	138
7.9	Working with noninvasive modes.....	138
7.10	Working with ASV.....	141

7.1 Overview

The HAMILTON-S1 offers a full range of ventilation modes that provide full and partial ventilatory support.

The primary aims of mechanical ventilation are:

- Elimination of CO₂
- Oxygenation
- Decreased work of breathing
- Patient synchronization

The detailed mode descriptions provided in this chapter illustrate how the controls work to achieve these goals.

7.1.1 Breath types and timing options

Hamilton Medical ventilators support two main breathing methods: mandatory breaths and spontaneous breaths.

Mandatory breaths. The start of inspiration (triggering) is determined by the ventilator or the patient. The end of inspiration (cycling) is determined by the ventilator.

Spontaneous breaths. The start of inspiration (triggering) and end of inspiration (cycling) is determined by the patient. The patient breathes independently or receives support from the ventilator.

The ventilator controls mandatory breath timing using a combination of inspiratory time (TI) and Rate.

For some modes, you can set the ventilator to use any of the following combinations to control breath timing: I:E/Pause, Ti/Pause, %Ti/Pause, or Peak Flow/Tip.

To select the breath timing to use, see Section 14.3.2.

Figure 7-1. Breath timing parameters

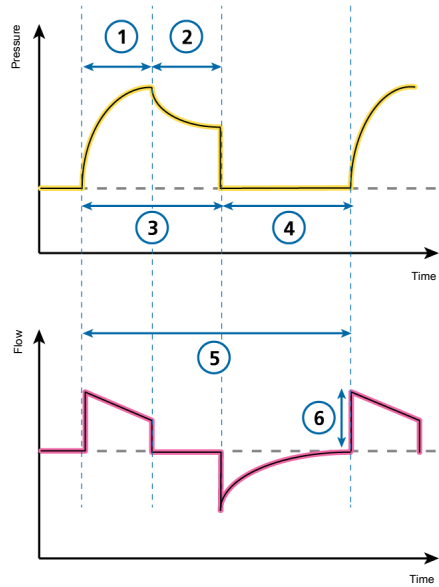

- | | | | |
|---|--------------|---|-----------|
| 1 | TI or %TI | 4 | I:E ratio |
| 2 | Pause or Tip | 5 | Rate |
| 3 | I:E ratio | 6 | Peak flow |

Note that in the breath patterns shown in this chapter, we show I:E. What is actually displayed on your device depends on the breath timing selection on the ventilator.

7.1.2 Ventilation modes

The choice of mode is a medical decision that depends on the patient's CO₂ elimination, oxygenation, activity, and breathing effort.

A ventilation mode combines breath type, breath sequence, and control variables.

Table 7-1. HAMILTON-S1 ventilation modes, description and applicable patient group

Mode name	Patient group	Mode
Volume-controlled modes, flow controlled		
(S)CMV	Adult/Pediatric	Breaths are volume controlled and mandatory, including patient-triggered breaths.
SIMV	Adult/Pediatric	A fixed rate is set for volume-controlled mandatory breaths. These breaths can be alternated with pressure-supported spontaneous breaths.
Volume-controlled modes, flow cycled		
VS	All	Breaths are flow cycled and deliver a set tidal volume to support patient-initiated breaths.
Volume-targeted modes, adaptive pressure controlled		
APVcmv	All	Breaths are volume targeted and mandatory.
APVsimv	All	Volume-targeted mandatory breaths can be alternated with pressure-supported spontaneous breaths.
Pressure-controlled modes		
P-CMV	All	All breaths, whether triggered by the patient or the ventilator, are pressure-controlled and mandatory.
P-SIMV	All	Mandatory breaths are pressure controlled. Mandatory breaths can be alternated with pressure-supported spontaneous breaths.
DuoPAP	All	Mandatory breaths are pressure controlled. Spontaneous breaths can be triggered at both pressure levels.
APRV	All	Spontaneous breaths can be continuously triggered. The pressure release between the levels contributes to ventilation.
SPONT	All	Every breath is spontaneous, with or without pressure-supported spontaneous breaths.
Intelligent ventilation		
ASV	Adult/Pediatric	Operator sets %MinVol, PEEP, and Oxygen. Frequency, tidal volume, pressure, and I:E ratio are based on physiological input from the patient.
INTELLiVENT-ASV	Adult/Pediatric	Fully automated management of ventilation and oxygenation based on physiological input from the patient. The underlying mode is ASV.

Mode name	Patient group	Mode
Noninvasive modes		
NIV	All	Every breath is spontaneous.
NIV-ST	All	Every breath is spontaneous as long as the patient is breathing above the set rate. A backup rate can be set for mandatory breaths.
nCPAP-PS	Neonatal	Every breath is spontaneous as long as the patient is breathing above the set rate. A backup rate can be set for mandatory breaths.
Hi Flow O2	All	High flow oxygen therapy. No supported breaths.

7.1.3 Ventilation controls and settings

The table on the following page provides an overview of all of the modes and their control settings.

Mode type	Intelligent Ventilation		Vol targeted, adaptive press control		Volume controlled		Volume support	Pressure controlled						Noninvasive			
	ASV ***	INTELLIVENT-ASV***	APV/cmv	APV/aimv	(S)CMV ***	SIMV ***		VS	P-CMV	P-SIMV	DuoPAP	APRV	SPONT	NIV	NIV-ST	nCPAP-PS**	HIFlow O2
Mode	--	--	Rate	Rate	Rate	Rate	--	Rate	Rate	Rate	T low	--	--	Rate	Rate	Rate	--
Timing	--	--	* Vtarget	TI	* Vt	* Vt	--	* Pcontrol	TI	T high	T high	--	--	TI	TI	TI	--
Mandatory breaths	--	--	Vtarget	Vtarget	Vt	Vt	--	Pcontrol	Pcontrol	P high	P high	--	--	--	--	--	--
Spontaneous breaths	--	--	--	Psupport	--	Psupport	Vtarget	Pcontrol	Psupport	Psupport	Psupport	Psupport	Psup port	Psupport	Psupport	Psupport	--
	ETS	ETS	ETS	ETS	--	ETS	ETS	ETS	ETS	ETS	ETS	ETS	ETS	ETS	ETS	ETS	ETS
	--	--	--	--	--	--	--	--	--	--	--	--	TI max	TI max	TI max	TI max	--
Baseline press. PEEP/CPAP	X	AUTO	X	X	X	X	X	X	X	X	P low	X	X	X	X	X	--
Trigger	X	X	X	X	X	X	X	X	X	X	X	X	X	X	X	X	--
P-ramp	X	X	X	X	--	X	X	X	X	X	X	X	X	X	X	X	--
Oxygen	X	AUTO	X	X	X	X	X	X	X	X	X	X	X	X	X	X	X
Gender	X	X	X	X	X	X	X	X	X	X	X	X	X	X	X	X	X
Patient height	X	X	X	X	X	X	X	X	X	X	X	X	X	X	X	X	X
Mode specific	%MinVol	AUTO %MinVol	--	--	Flow Pattern	Flow Pattern	--	--	--	--	--	--	--	--	--	--	Flow
	P ASV limit	P ASV limit	--	--	Pause	Pause	Pause	Pause	Pause	Pause	Pause	Pause	Pause	Pause	Pause	Pause	Flow
Sigh	X	X	X	X	X	X	X	X	X	X	X	X	X	X	X	X	--
Apnea backup	--	--	--	APV/cmv	--	(S)CMV	APV/cmv	--	P-CMV	P-CMV	P-CMV	P-CMV	P-CMV	P-CMV	P-CMV	P-CMV	--

* I:E/Pause, TI/Pause, or Peak flow/TIP
 ** Neonatal only
 *** Adult/Peed only
 X applies to this mode
 -- not applicable

7.2 Volume-controlled modes, flow control

The following modes are volume controlled, with flow control:

- (S)CMV
- SIMV

7.2.1 (S)CMV mode

(S)CMV stands for *synchronized controlled mandatory ventilation*.

Breaths in (S)CMV mode are volume-controlled and mandatory.

The breath can be triggered by the ventilator or by the patient. If the breath is spontaneous (triggered by the patient), the inspiratory rate may increase.

If a breath is not triggered by patient effort within a preset time, the ventilator delivers a set tidal volume with a constant flow or operator-selected flow pattern for a set inspiratory time at a set respiratory rate.

The ventilator always delivers the set tidal volume; pressure in the airway can increase or decrease depending on the resistance and compliance of the patient's lungs.

To protect the patient's lungs it is important to carefully set an upper pressure limit.

- The tidal volume (V_t) setting defines the delivered volume.
- The Rate and I:E define the timing of the breath cycle.
- The Pause setting (in %) is always set in relation to the total breath time.

Figure 7-2. (S)CMV mode: Breathing pattern and controls

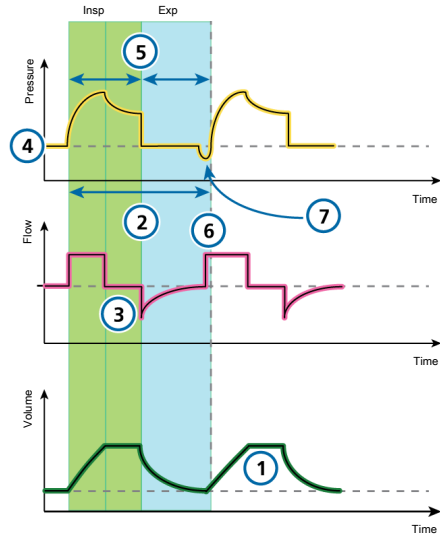

Ventilator controls

CO₂ elimination

- | | | | |
|---|-------|---|------------------|
| 1 | V_t | 3 | Pause |
| 2 | Rate | | Sigh (not shown) |

Oxygenation

- | | | | |
|---|-------------------|---|--------------------|
| 4 | PEEP | 6 | FlowPattern |
| 5 | I:E ²⁰ | | Oxygen (not shown) |

Patient synchronization

- | | |
|---|---------|
| 7 | Trigger |
|---|---------|

²⁰ Depending on the selected breath timing philosophy (I:E, TI, or other supported option, if available).

7.2.2 SIMV mode

SIMV stands for *synchronized intermittent mandatory ventilation*.

The SIMV mode combines attributes of the (S)CMV and SPONT modes, delivering volume-controlled mandatory breaths or pressure-supported spontaneous (patient-triggered) breaths.

SIMV mode ensures that the set target volume is delivered during the mandatory breaths. After the mandatory breath is delivered, the patient is free to take any number of spontaneous breaths for the remainder of the SIMV breath interval.

Each SIMV breath interval includes mandatory time (T_{mand}) and spontaneous time (T_{spont}).

If the patient triggers a breath during T_{mand} , the ventilator immediately delivers a mandatory breath. If the patient triggers a breath during T_{spont} , the ventilator delivers a spontaneous, pressure-supported breath.

If the patient does not trigger a breath during T_{spont} , the ventilator automatically delivers a mandatory breath at the end of T_{mand} .

In SIMV mode, parameters for both the mandatory and spontaneous breath types are set.

- The tidal volume (V_t) setting defines the delivered volume of mandatory breaths.
- Rate and I:E define the timing of the breath cycle.
- $P_{support}$ defines the pressure support above PEEP. For spontaneous breaths, the expiratory trigger sensitivity (ETS)

setting defines the percentage of peak flow that cycles the ventilator into exhalation.

Figure 7-3. SIMV mode: Breathing pattern and controls

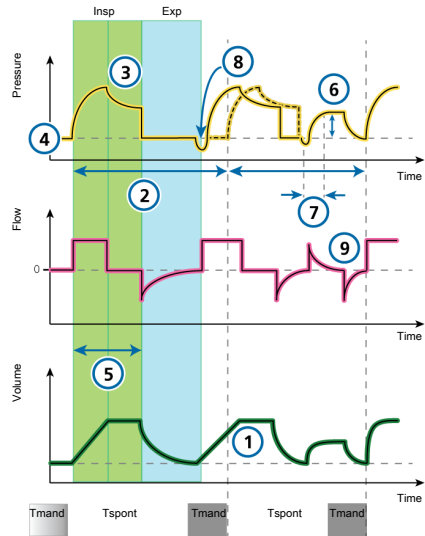

Ventilator controls

CO₂ elimination

- | | |
|---------|---------------------------|
| 1 V_t | 3 Pause |
| 2 Rate | Sigh (<i>not shown</i>) |

Oxygenation

- | | |
|---------------------|---|
| 4 PEEP | 6 $P_{support}$ |
| 5 I:E ²¹ | Oxygen (<i>not shown</i>)
FlowPattern (<i>not shown</i>) |

Patient synchronization

- | | |
|-----------|-------|
| 7 P-ramp | 9 ETS |
| 8 Trigger | |

²¹ Depending on the selected breath timing philosophy (I:E, TI, or other supported option, if available).

7.3 Volume-controlled modes, flow cycled

The Volume Support mode is a flow-cycled, volume controlled mode.

7.3.1 Volume Support (VS)

Volume Support (VS) mode is for spontaneously breathing patients. The ventilator provides flow-cycled support to patient-initiated breaths to deliver the desired tidal volume, at a level appropriate to the patient's efforts. This mode allows the ventilator to vary the support in response to changing patient conditions and inspiratory effort levels.

This mode guarantees that a set tidal volume is delivered. To achieve this volume, the device decreases support when the patient's breathing activity increases, and conversely, increases support when the patient's inspiratory efforts decrease.

When VS mode is selected, the ventilator works with the first four breaths as follows:

- *Assessing the breathing pattern.* The VS mode starts by determining the patient's volume/pressure response (V/P) based on the previous ventilation or on a sequence of three (3) test breaths. V/P is defined as: $V_t / (P_{\text{peak}} - \text{PEEP}/\text{CPAP})$
- *Achieving the target volume.* The ventilator uses V/P to calculate the lowest inspiratory pressure applied to achieve the target tidal volume (V_{target}). The minimum pressure delivered is 3 cmH₂O above PEEP.

The operator sets V_{target} , PEEP/CPAP, and the high Pressure alarm limit. The adaptive controller compares the monitored V_t to V_{target} . If the patient's current tidal volume is equal to V_{target} , the ventilator maintains the inspiratory pressure. If the monitored volume is higher or lower than the target volume, the inspiratory pressure is gradually adjusted by up to 2 cmH₂O per breath to attain the target level.

The inspiratory pressure is adjusted within this range: (PEEP + 3 cmH₂O) to (high Pressure alarm limit – 10 cmH₂O). In this case, we recommend a high Pressure alarm limit setting at least 10 cmH₂O above the peak pressure. The PAW waveform on the ventilator displays a blue band 10 cmH₂O below the set high Pressure alarm limit.

- *Maintaining the target volume with the lowest inspiratory pressure.* The parameters needed for VS are measured breath by breath. When required, the ventilator recalculates the minimum inspiratory pressure to achieve the target volume based on the current lung characteristics. The minimum inspiratory pressure is limited to a minimum of 3 cmH₂O above PEEP.

The continuous reassessment of the patient's dynamic lung status is designed to guarantee the required ventilation while preventing hypoventilation or barotrauma.

Figure 7-4. Volume Support mode: Breathing pattern and controls

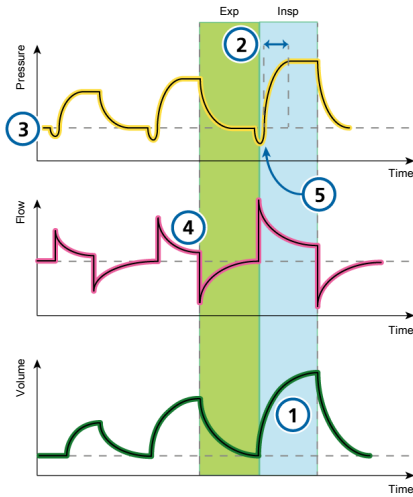

- | | |
|----------|-------------|
| 1 Vt | 4 P-Trigger |
| 2 P-ramp | 5 ETS |
| 3 PEEP | |

7.4 Volume-targeted modes, adaptive pressure control

The following modes are volume targeted, with adaptive pressure control:

- APVcmv
- APVsimv

NOTICE

- The minimum inspiratory pressure ($P_{peak} - PEEP$) in APVcmv and APVsimv modes is 5 cmH₂O. Be aware that a small set tidal volume with high lung compliance may lead to higher-than-expected tidal volumes.
- For adaptive modes, such as APVcmv or APVsimv, be sure the Pressure alarm is set appropriately. This alarm provides a safety pressure limit for the device to appropriately adjust the inspiratory pressure necessary to achieve the target tidal volume.

The maximum available inspiratory pressure is 10 cmH₂O below the high Pressure limit, indicated by a blue line on the pressure waveform display.

If the Pressure limit is set too low, there may not be enough margin for the device to adjust its inspiratory pressure to deliver the target tidal volume.

7.4.1 APVcmv mode

APVcmv stands for *adaptive pressure ventilation with controlled mandatory ventilation*.

APVcmv is a volume-targeted pressure-controlled ventilation mode. It functions similarly to the conventional volume-controlled mode of ventilation, (S)CMV, except that pressure is the control variable rather than flow. Pressure is adjusted between breaths to achieve the target tidal volume.

The breath can be triggered by the ventilator or by the patient. If the breath is triggered by the patient, the inspiratory rate may increase.

The ventilator uses the high Pressure alarm limit minus 10 cmH₂O as a safety boundary for its inspiratory pressure adjustment, and does not exceed this value. An exception is sigh breaths, when the ventilator may apply inspiratory pressures 3 cmH₂O below the high Pressure alarm limit.

Breaths in APVcmv mode are volume-targeted and mandatory, delivered at the lowest possible pressure depending on lung conditions.

The operator sets the target tidal volume (V_t).

The ventilator delivers the set target volume (V_t) at a preset rate. The patient can trigger mandatory breaths between preset rate breaths.

Figure 7-5. APVcmv: Breathing pattern and controls

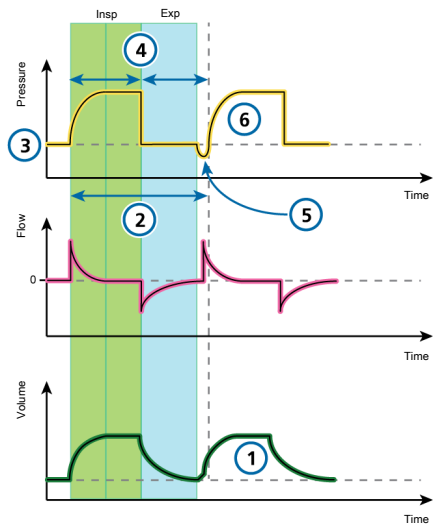

Ventilator controls

CO2 elimination

- 1 Vt
- 2 Rate

Sigh (not shown)

Oxygenation

- 3 PEEP
- 4 I:E²²

Oxygen (not shown)

Patient synchronization

- 5 Trigger
- 6 P-ramp

²² Depending on the selected breath timing philosophy (I:E, TI, or other supported option, if available).

7.4.2 APVsimv mode

APVsimv stands for *adaptive pressure ventilation with synchronized intermittent mandatory ventilation*.

The APVsimv mode combines attributes of the APVcmv and SPONT modes, delivering volume-targeted mandatory breaths or pressure-supported spontaneous (patient-triggered) breaths.

APVsimv mode ensures that the set target volume is delivered during the mandatory breaths.

After the mandatory breath is delivered, the patient is free to take any number of spontaneous breaths for the remainder of the APV breath interval.

The ventilator uses the high Pressure limit minus 10 cmH₂O as a safety boundary for its inspiratory pressure adjustment, and does not exceed this value. An exception is sigh breaths, when the ventilator may apply inspiratory pressures 3 cmH₂O below the high Pressure limit.

Each breath interval includes mandatory time (T_{mand}) and spontaneous time (T_{spont}).

- If the patient triggers a breath during T_{mand}, the ventilator immediately delivers a mandatory breath.
- If the patient triggers a breath during T_{spont}, the ventilator delivers a spontaneous pressure-supported breath.

If the patient does not trigger a breath during T_{spont}, the ventilator automatically delivers a mandatory breath at the end of T_{mand}.

In this mode, parameters for both mandatory and spontaneous breath types are set.

- The tidal volume (V_t) setting defines the delivered volume of mandatory breaths.
- Rate and I:E define the timing of the breath cycle for mandatory breaths.
- For spontaneous breaths, P_{support} defines the pressure support above PEEP. ETS defines the inspiratory timing of the breaths.

Figure 7-6. APVsimv: Breathing pattern and controls

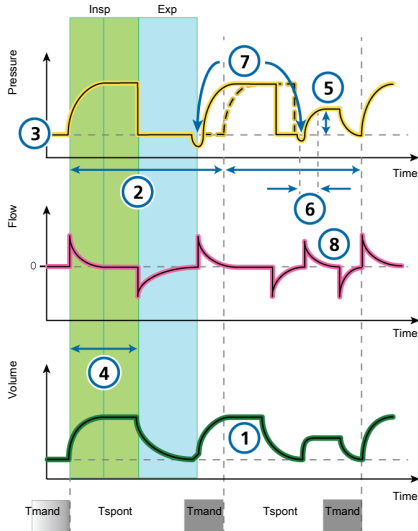

Ventilator controls

CO₂ elimination

- 1 Vt 2 Rate

Sigh (*not shown*)

Oxygenation

- 3 PEEP 5 Psupport
4 I:E²³ Oxygen (*not shown*)

Patient synchronization

- 6 P-ramp 8 ETS
7 Trigger

²³ Depending on the selected breath timing philosophy (I:E, TI, or other supported option, if available).

7.5 Pressure-controlled modes

The following modes are pressure controlled:

- P-CMV
- P-SIMV
- DuoPAP
- APRV
- SPONT

7.5.1 P-CMV mode

P-CMV stands for *pressure-controlled ventilation*.

Breaths in P-CMV mode are pressure controlled and mandatory.

The ventilator delivers a constant level of pressure, so the volume depends on the pressure settings, the inspiration time, and the resistance and compliance of the patient's lungs.

In P-CMV mode, parameters are set only for mandatory breaths.

- The pressure control (Pcontrol) setting defines the applied pressure above PEEP.
- Rate and I:E define the timing of the breath cycle.
- The P-ramp setting controls the speed with which the ventilator arrives at the desired pressure.

Figure 7-7. P-CMV mode: Breathing pattern and controls

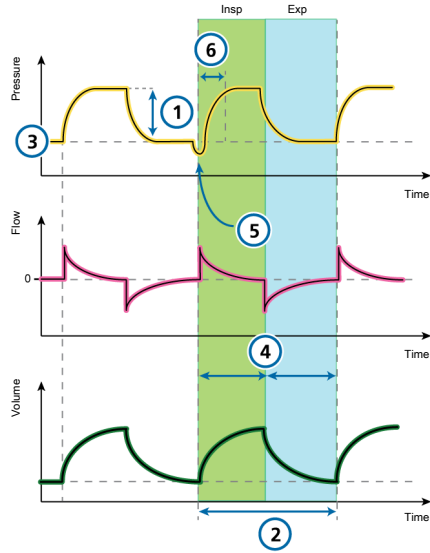

Ventilator controls

CO2 elimination

- | | |
|------------|--------|
| 1 Pcontrol | 2 Rate |
|------------|--------|

Sigh (not shown)

Oxygenation

- | | |
|--------|---------------------|
| 3 PEEP | 4 I:E ²⁴ |
|--------|---------------------|

Oxygen (not shown)

Patient synchronization

- | | |
|-----------|----------|
| 5 Trigger | 6 P-ramp |
|-----------|----------|

²⁴ Depending on the selected breath timing philosophy (I:E, TI, or other supported option, if available).

7.5.2 P-SIMV mode

P-SIMV stands for *pressure-controlled synchronized intermittent mandatory ventilation*.

In P-SIMV mode, the mandatory breaths are P-CMV breaths. These can be alternated with spontaneous breaths.

Each SIMV breath interval includes mandatory time (Tmand) and spontaneous time (Tspont).

- If the patient triggers a breath during Tmand, the ventilator immediately delivers a mandatory breath.
- If the patient triggers a breath during Tspont, the ventilator delivers a spontaneous, pressure-supported breath.
- If the patient does not trigger a breath during Tspont, the ventilator automatically delivers a mandatory breath at the end of Tmand.

In P-SIMV mode, parameters for both mandatory and spontaneous breath types are set.

- For mandatory breaths, the pressure control (Pcontrol) setting defines the applied pressure above PEEP. Rate and I:E define the timing of the breath cycle. Rate and I:E define the timing of the breath cycle.
- For spontaneous breaths, Psupport defines the pressure support above PEEP. ETS defines the inspiratory timing of the breaths.

Figure 7-8. P-SIMV mode: Breathing pattern and controls

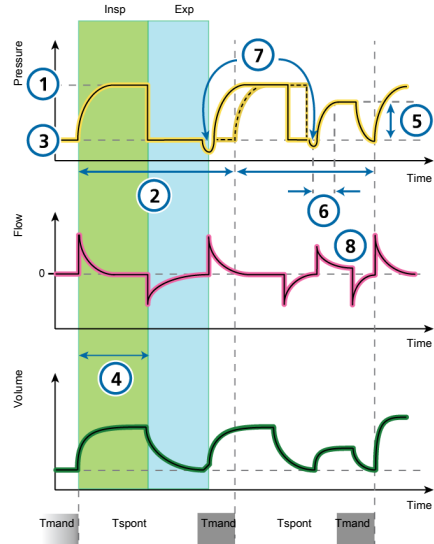

Ventilator controls

CO2 elimination

- | | |
|------------------|--------|
| 1 Pcontrol | 2 Rate |
| Sigh (not shown) | |

Oxygenation

- | | |
|---------------------|--------------------|
| 3 PEEP | 5 Psupport |
| 4 I:E ²⁵ | Oxygen (not shown) |

Patient synchronization

- | | |
|-----------|-------|
| 6 P-ramp | 8 ETS |
| 7 Trigger | |

²⁵ Depending on the selected breath timing philosophy (I:E, TI, or other supported option, if available).

7.5.3 DuoPAP mode

DuoPAP stands for *duo positive airway pressure*.

DuoPAP is a type of pressure ventilation designed to support spontaneous breathing on two alternating levels of CPAP.

In this mode, the ventilator switches automatically and regularly between two operator-selected levels of positive airway pressure or CPAP.

Cycling between the levels is triggered by DuoPAP timing settings or by patient effort.

In DuoPAP, the switch-over between the two levels is defined by the pressure settings, P high and PEEP/CPAP, and the time settings, T high and Rate.

Note the following:

- At conventional settings and in the absence of spontaneous breathing, DuoPAP resembles P-CMV.
- As you decrease the rate, keeping T high short relative to the time at the lower pressure level, the mode looks more like P-SIMV, with spontaneous breaths following mandatory breaths.
- If T high is set to almost the breath cycle time with just enough time at the low level to allow full or near-full exhalation, this mode looks like APRV (Section 7.5.4).

Pressure support can be set to assist spontaneous breaths in DuoPAP, whether they occur at the PEEP/CPAP or P high level.

Psupport is set relative to (above) PEEP/CPAP, which means that spontaneous breaths at the P high level are supported only when this target pressure is greater than P high.

Figure 7-9. DuoPAP mode: Breathing pattern and controls

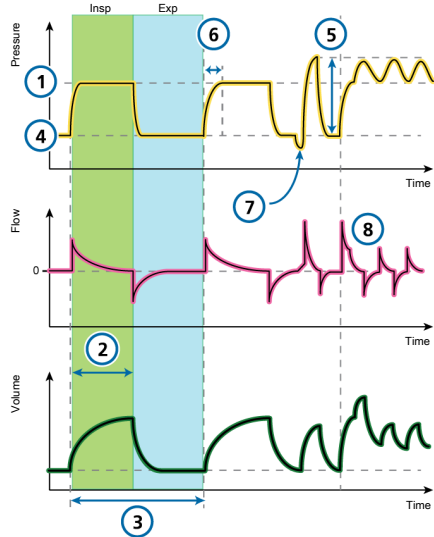

Ventilator controls

CO2 elimination

- | | |
|----------|--------|
| 1 P high | 3 Rate |
| 2 T high | |

Oxygenation

- | | |
|-------------|------------|
| 4 PEEP/CPAP | 5 Psupport |
|-------------|------------|

Oxygen (*not shown*)

Patient synchronization

- | | |
|------------------------|-------|
| 6 P-ramp ²⁶ | 8 ETS |
| 7 Trigger | |

²⁶ Pressure rise time to P high and Psupport.

7.5.4 APRV mode

APRV stands for *airway pressure release ventilation*.

Set airway pressure **P high** is transiently released to a lower level **P low**, after which it is quickly restored to reinflate the lungs.

For a patient who has no spontaneous breathing efforts, APRV is similar to pressure-controlled inverse ratio ventilation.

APRV allows spontaneous breathing at any time during the respiratory cycle.

APRV is an independent mode. When changing modes, the pressure and timing settings from any other mode are not transferred to APRV, and vice versa. When switching to APRV for the first time, the timing and pressure settings proposed are based on Table 7-2.

Table 7-2. Default settings for APRV (Adult/Ped)

Patient group	P high / P low (cmH ₂ O)	T high (s)	T low (s)
Adult	20 / 5	1.3	0.5
Pediatric	20 / 5	0.8	0.3
Neonatal	20 / 5	0.6	0.2

Figure 7-10. APRV mode: Breathing pattern and controls

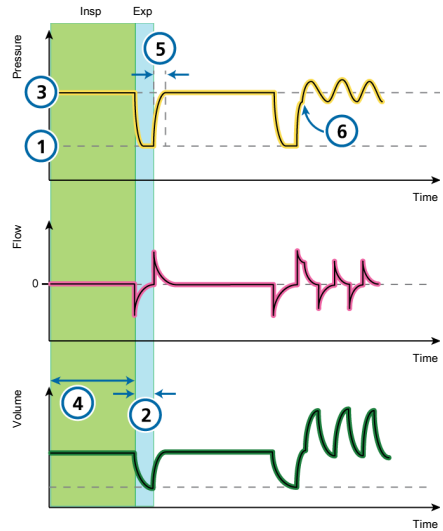

Ventilator controls

CO₂ elimination

- 1 P low 2 T low

Oxygenation

- 3 P high²⁷ 4 T high

Oxygen (*not shown*)

Patient synchronization

- 5 P-ramp (to P high) 6 Trigger

²⁷ With prolonged T high settings and short T low settings, the P high setting in effect becomes the PEEP level.

7.5.5 SPONT mode

SPONT stands for *spontaneous mode*.

SPONT delivers spontaneous breaths and operator-initiated manual, mandatory breaths.

When pressure support is set to zero, the ventilator functions like a conventional CPAP system.

- The pressure support (P_{support}) setting defines the applied pressure during inspiration.
- ETS defines the inspiratory timing of the breaths.
- The PEEP setting defines the PEEP applied during expiration.

Figure 7-11. SPONT mode: Breathing pattern and controls

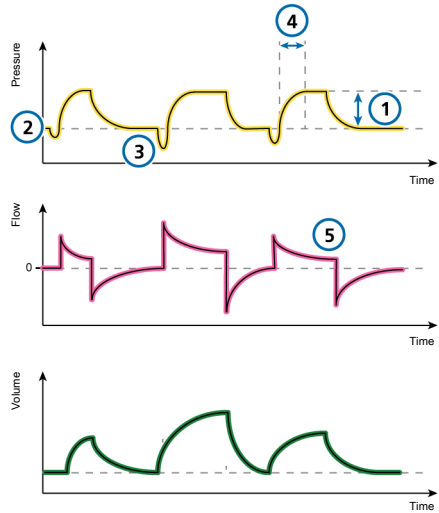

Ventilator controls

CO₂ elimination

- 1 P_{support} Sigh (*not shown*)

Oxygenation

- 2 PEEP Oxygen (*not shown*)

Patient synchronization

- 3 Trigger 5 ETS
4 P-ramp

7.6 Intelligent Ventilation

The following are volume-controlled Intelligent Ventilation modes:

- ASV™
- INTELLiVENT-ASV™

ASV and INTELLiVENT-ASV are not available for neonatal patients.

7.6.1 ASV mode

ASV stands for *adaptive support ventilation*.

ASV maintains an operator-preset, minimum minute ventilation independent of the patient's breathing activity.

The target breathing pattern (tidal volume and inspiratory rate) is calculated by the ventilator, based on the assumption that the optimal breath pattern results in the least work of breathing, and the minimal force of breathing also results in the least amount of ventilator-applied inspiratory pressure when there is no patient breathing effort. For initial settings, see Table 7-3.

ASV adjusts inspiratory pressure and machine rate on a breath-by-breath basis taking into account the changing patient condition (resistance, compliance, RC_{exp}) and applying lung-protective strategies to meet the targets.

A decrease in pressure limitation will follow with a decrease in tidal volume (V_t) and an increase in **Rate**.

Figure 7-12. ASV mode: Breathing pattern and controls

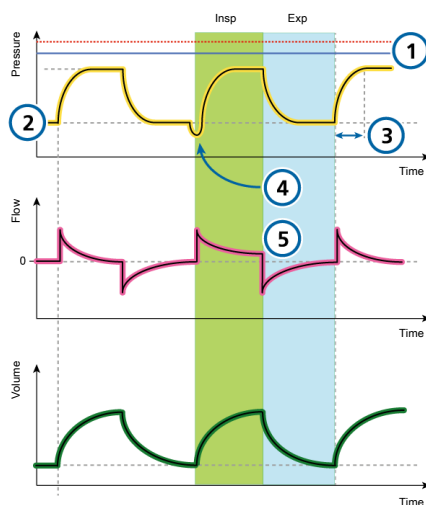

Ventilator controls

CO₂ elimination

- | | | |
|---|-------------|---------------------------|
| 1 | P ASV limit | Sigh (<i>not shown</i>) |
| | %MinVol | (<i>not shown</i>) |

Oxygenation

- | | | |
|---|-----------|-----------------------------|
| 2 | PEEP/CPAP | Oxygen (<i>not shown</i>) |
|---|-----------|-----------------------------|

Patient synchronization

- | | | | |
|---|---------|---|-----|
| 3 | P-ramp | 5 | ETS |
| 4 | Trigger | | |

ASV maintains a **preset minimum minute ventilation**:

- Automatically and smoothly adjusts for changing patient conditions between active and passive states
- Mandatory breaths are pressure controlled
- Spontaneous breaths are pressure supported
- Prevents tachypnea

- Prevents AutoPEEP
- Prevents dead space ventilation
- Does not exceed a P_{insp} pressure of **10 cmH₂O below the upper pressure limit**

The operator sets the %MinVol, PEEP, and Oxygen.

For details about working with ASV, see Section 7.10.

Table 7-3. ASV mode initial breath pattern settings

Patient group	IBW (kg)	P _{insp} (cmH ₂ O)	TI (s)	Initial rate (b/min)
Pediatric	3 to 5	15	0.4	30
	6 to 8	15	0.6	25
	9 to 11	15	0.6	25
	12 to 14	15	0.7	20
	15 to 20	15	0.8	20
	21 to 23	15	0.9	20
	24 to 29	15	1	20
	> 30	15	1	20
Adult	10 to 29	15	1	20
	30 to 39	15	1	18
	40 to 59	15	1	15
	60 to 89	15	1	15
	90 to 99	18	1.5	15
	> 100	20	1.5	15

7.6.1.1 ASV and ASV 1.1

ASV 1.1 is the default setting for the ASV mode. The previous version of ASV is also available on the device, and can be selected in Configuration.

ASV 1.1 extends the use of ASV with the following additional features and changes:

- Increased target rate and reduced tidal volumes for the majority of patients compared to standard ASV.
- In cases of high time constants and high minute volumes, V_t max is limited to 15 ml/kg.

For details about working with ASV, see Section 7.10.

7.6.2 INTELLiVENT-ASV mode

INTELLiVENT-ASV is an advanced ventilation mode, based on the proven Adaptive Support Ventilation (ASV) mode, to automatically regulate CO₂ elimination and oxygenation for both passive and active patients, based on both physiologic data from the patient and clinician-set targets.

With this mode, the clinician sets targets for PetCO₂ and SpO₂ for the patient. INTELLiVENT-ASV then automates management of the controls for CO₂ elimination (%MinVol), and oxygenation (PEEP and Oxygen) based on these targets and on the physiologic input from the patient (PetCO₂ and SpO₂).

INTELLiVENT-ASV continuously monitors patient conditions and automatically and safely adjusts parameters to keep the patient within target ranges, with minimal clinician interaction, from intubation to extubation.

For operation details, see the *INTELLiVENT-ASV Operator's Manual*.

7.7 Noninvasive modes

The following modes are noninvasive:

- NIV
- NIV-ST
- nCPAP-PS
- Hi Flow O2

The NIV and NIV-ST modes are implementations of noninvasive positive pressure ventilation (NPPV).

nCPAP-PS is a neonatal mode that offers nasal continuous positive airway pressure and intermittent positive pressure support through a nasal interface (mask or prongs) for infants and neonates.

Hi Flow O2 is a mode that delivers a continuous air/gas mixture to the patient.

For details about working with noninvasive modes, see Section 7.9.

7.7.1 NIV mode

NIV stands for *noninvasive ventilation*.

NIV mode delivers spontaneous breaths.

NIV is designed for use with a mask or other noninvasive patient interface.

When pressure support is set to zero, the ventilator functions like a conventional CPAP system.

- The pressure support (**Psupport**) setting defines the applied pressure during inspiration.
- ETS defines the inspiratory timing of the breaths.
If the ventilator does not detect an expiratory trigger (for example, due to a leak), inspiratory time is limited by **TI max**.

- The PEEP setting defines the PEEP applied during expiration.

For additional details about working with noninvasive modes, see Section 7.9.

Figure 7-13. NIV mode: Breathing pattern and controls

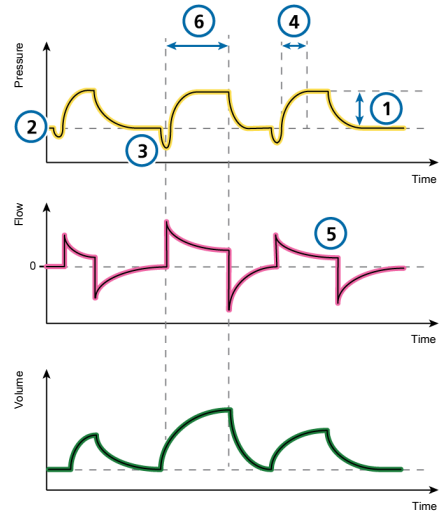

Ventilator controls

CO2 elimination

- | | |
|------------|------------------|
| 1 Psupport | Sigh (not shown) |
|------------|------------------|

Oxygenation

- | | |
|--------|--------------------|
| 2 PEEP | Oxygen (not shown) |
|--------|--------------------|

Patient synchronization

- | | |
|-----------|----------|
| 3 Trigger | 5 ETS |
| 4 P-ramp | 6 TI max |

7.7.2 NIV-ST mode

NIV-ST stands for *spontaneous/timed non-invasive ventilation*.

NIV-ST mode delivers time-cycled or flow-cycled breaths. Every patient trigger results in a flow-cycled, pressure-supported breath.

If the rate of patient-triggered breaths falls below the set mandatory Rate, time-cycled breaths are delivered at the set Rate and timing.

If the patient triggers a breath during the breath interval *timv*, the ventilator immediately delivers a spontaneous breath. If the patient does not trigger an inspiration during this time, the ventilator initiates a mandatory breath at the end of *timv*.

When pressure support is set to zero, the ventilator functions like a conventional CPAP system.

This mode requires that you set the parameters needed for both mandatory and spontaneous breath types.

- The inspiratory pressure setting, *Pinsp*, defines the applied pressure for both mandatory and spontaneous breaths.
- The *Rate* and *TI* (inspiratory time) control settings define the breath timing.
- For spontaneous breaths, the *ETS* setting defines the percentage of peak flow that cycles the device into exhalation.

If the ventilator does not detect an expiratory trigger (for example, due to a leak), inspiratory time is limited by *TI max*.

Figure 7-14. NIV-ST mode: Breathing pattern and controls

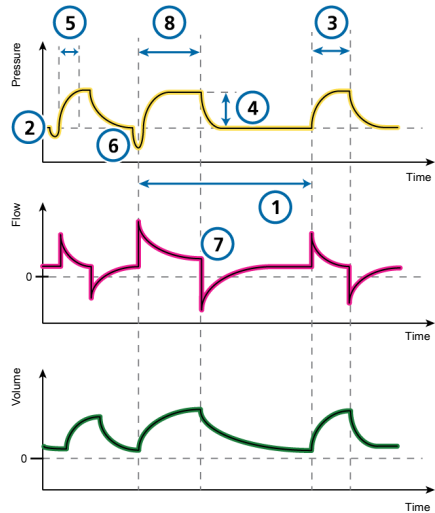

Ventilator controls

CO2 elimination

- | | | |
|---|------|------------------|
| 1 | Rate | Sigh (not shown) |
|---|------|------------------|

Oxygenation

- | | | | |
|---|------|---|----|
| 2 | PEEP | 3 | TI |
|---|------|---|----|
- Oxygen (not shown)

Patient synchronization

- | | | | |
|---|--------------|---|--------|
| 4 | <i>Pinsp</i> | 7 | ETS |
| 5 | P-ramp | 8 | TI max |
| 6 | Trigger | | |

7.7.4 High flow oxygen therapy

High flow oxygen (Hi Flow O2) is indicated for adult, pediatric, and neonatal patients who are able to inhale and exhale spontaneously.²⁸

Hi Flow O2 is an optional therapy in which a continuous flow of heated and humidified respiratory gases are delivered to the patient. The set flow can vary from 1 to 60 l/min, depending on the patient interface. An operating humidifier is required.

The operator sets the oxygen and flow rate. If a flow sensor is connected, PEEP is monitored.

Pressure is measured at the ventilator's pressure release valve. Flow stops and the safety valve opens if pressure exceeds the set high Pressure alarm limit. Therapy resumes when the pressure is released.

This respiratory support is usually delivered through a nasal cannula, with the flow exceeding the patient's peak inspiratory flow to provide inspired oxygen of up to 100%.

High flow oxygen therapy can be delivered using single or double limb breathing circuits, using a high-flow nasal cannula or a tracheal adapter/tracheal mask to enable the patient to exhale.

Note that during high flow oxygen therapy, disconnection and apnea alarms are inactive.

7.7.4.1 Delivering high flow oxygen therapy

Note that you must be in Standby to change the mode.

To deliver high flow oxygen therapy

1. Set up the patient with an appropriate breathing circuit. Figures 2-8 and 2-10 show a noninvasive circuit set.
2. Place the ventilator in Standby, and open the Modes window.
3. Touch the Hi Flow O2 mode button and touch **Confirm**.

The Controls window opens.

Be sure to carefully read the safety information displayed in the window:



Use only interfaces intended for high flow O2.

The use of unsuitable interfaces poses a risk to the patient.

Active humidification is mandatory.

4. Set the desired values for **Oxygen** and **Flow**, then touch **Confirm**.

You can change these settings any-time.

The Standby window is displayed, showing the **Start therapy** button.

5. Perform the preoperational checks, especially the tightness test. See Section 5.4.

²⁸ Not available in all markets.

6. In the Standby window, touch **Start therapy** to begin the oxygen therapy. The main display changes to show the following safety information about oxygen therapy in addition to graphics and parameter values related to the therapy.



Hi Flow O2 therapy
No apnea detection!
No disconnection detection!

7.7.4.2 Parameters monitored in Hi Flow O2 mode

When high flow oxygen therapy is in progress, the following parameters are monitored: **Oxygen**, **Flow**, and **Paux**, as well as **SpO2**, if enabled.

7.8 Ambient state

If the technical fault alarm is serious enough to possibly compromise safe ventilation, the ventilator enters the Ambient state.

The following conditions apply to ventilation in the Ambient state:

- The inspiratory channel and expiratory valves are opened, letting the patient breathe room air unassisted.
- Provide alternative ventilation immediately.
- You must turn off ventilator power to exit the Ambient state.

7.9 Working with noninvasive modes

This section provides an overview of non-invasive ventilation requirements, contraindications for use, and important information about settings and alarms.

When using NPPV, you can use a mask, mouthpiece, or helmet-type patient interface rather than an invasive conduit such as an endotracheal tube.

7.9.1 Required conditions for use

Before proceeding, review the safety information in Chapter 1.

The following requirements **must be met** to use noninvasive ventilation:

- The patient must be able to trigger the ventilator and must have regular spontaneous breaths.
Noninvasive ventilation is intended to provide supplemental ventilatory support to patients with regular spontaneous breaths.
- The patient must be conscious.
- The patient must be able to maintain an adequate airway.
- Intubation must be possible at any time.
- The mask or interface is a good fit.

7.9.2 Contraindications

CAUTION

- *If you place an additional component, such as an HMEF, between the flow sensor and the patient, the additional resistance limits the ventilator's ability to identify disconnection at the patient.
To correctly identify a patient disconnection, be sure to appropriately set the lower limit of the Pressure alarm, as well as the Volume alarm limits, and carefully monitor the patient's SpO2 and, if available, PetCO2 values.*
- *To prevent possible patient injury, do NOT use noninvasive ventilation on patients with no or irregular spontaneous breaths. Noninvasive ventilation is intended to provide supplemental ventilatory support to patients with regular spontaneous breaths.*
- *To prevent possible patient injury, do NOT attempt to use noninvasive ventilation on intubated patients.*

Using noninvasive ventilation is contraindicated if **any** of the following conditions are met:

- The patient does not have the drive to breathe
- Partial or complete airway obstruction
- Gastrointestinal bleeding
- Anatomic or subjective intolerance of NIV interface

7.9.3 Potential adverse reactions

The following reactions to noninvasive ventilation are possible:

- Aspiration, gastric insufflation
- Increase of intracranial pressure (ICP)
- Decrease of arterial pressure
- CO2 rebreathing
- Claustrophobia
- Discomfort
- Dyssynchrony
- Skin or conjunctiva lesions

7.9.4 Control settings in noninvasive ventilation

WARNING

- The exhaled volume from the patient can differ from the measured exhaled volume due to leaks around the mask.
- Peak pressures exceeding 33 cmH2O may increase the risk of aspiration due to gastric insufflation. When ventilating with such pressures, consider using an invasive mode.

When a significant leak occurs, the inspiratory flow can never fall below ETS, thus not allowing the ventilator to cycle into exhalation and resulting in endless inspiration. The TI max setting provides an alternative way to cycle into exhalation. When inspiration lasts longer than TI max, the ventilator cycles into exhalation.

Ensure the TI max setting is sufficiently long to give ETS the chance to cycle the ventilator.

- Adjusting the TI max setting increases or decreases the allowable inspiratory time.
- Increasing ETS above the default 25% allows the ventilator to cycle to terminate inspiration at a higher flow, to accommodate larger leaks.

Other controls require special attention:

- Carefully observe the patient/ventilator interaction.
- Adjust Psupport or P_{insp} to obtain appropriate tidal volumes.
- The leakage in noninvasive modes can reduce the actual applied PEEP and give rise to autotriggering.
- Adjust PEEP further, considering oxygenation and AutoPEEP.

7.9.5 Alarms in noninvasive ventilation

Due to the changing and unpredictable amount of leakage, volume alarms are less meaningful in noninvasive modes than in other modes. Alarms are based on the returned expiratory gas volume measured at the flow sensor; this value can be significantly lower than the delivered tidal volume, because the delivered tidal volume is the sum of the displayed VTE and the leakage volume.

To avoid nuisance volume alarms, set the low V_t and ExpMinVol alarms to a low level.

Because the noninvasive modes are pressure modes, however, do pay attention to the pressure-related alarms. If the defined PEEP and inspiratory pressure can be maintained, the ventilator is compensating the gas leak sufficiently.

7.9.6 Monitored parameters in noninvasive ventilation

NOTICE

- The following numeric monitoring parameters cannot be used for reliable analysis of patient conditions: ExpMinVol, RCexp, R_{insp}, Insp Flow, AutoPEEP, and Cstat.
- Continuous monitoring of the clinical parameters and patient comfort is critically important.
- The parameters VTE NIV, MinVol NIV, MVSp_o NIV, and MVLeak are leak compensated, and are used in noninvasive modes. These parameters are estimations and may not reflect exact values.

Due to the leakage at the patient interface, displayed exhaled volumes in the noninvasive modes can be substantially smaller than the delivered volumes.

The flow sensor measures the delivered volume and the exhaled tidal volume; the ventilator displays the difference as VLeak in percent (%), and as MVLeak in l/min. Use VLeak and MVLeak to assess the fit of the mask or other noninvasive patient interface.

While a leak at the patient interface influences the tidal volume measurement, leaks in the breathing circuit itself do not influence the tidal volume measurement.

In addition to other clinical parameters, TI, P_{peak}, PEEP/CPAP, I:E, f_{Total}, P_{mean}, and f_{Spont} can be used to assess the patient's ventilatory status.

7.9.7 Additional notes about using noninvasive ventilation

Due to some unique characteristics, consider the following points when using noninvasive ventilation.

IntelliTrig (intelligent trigger) function

To synchronize, IntelliTrig compensates for leaks and resistance between the ventilator and the patient, and with each breath, it measures the leakage at the patient interface (mask).

With this information, IntelliTrig adjusts the trigger mechanism, reducing the influence of leakage and the changing breath pattern on the operator-set trigger sensitivity.

Maintaining PEEP and preventing autotriggering

Significant leakage can be present in noninvasive ventilation, which can serve to reduce the actual applied PEEP/CPAP and give rise to autotriggering. If you cannot reach the set PEEP/CPAP, check the mask fit.

The Loss of PEEP alarm alerts you to uncompensated leaks (that is, when the measured PEEP/CPAP is 3 cmH₂O lower than the set PEEP/CPAP).

Inspect mask fit and position

Inspect the mask position regularly and adjust as necessary. React promptly and appropriately to any alarms.

The ventilator's VLeak parameter provides one indicator of mask fit.

To verify that the mask fits properly, ensure that the leakage value shown in the Monitoring window (VLeak, MVLeak) is acceptable. To monitor leakage during ventilation, set the low limit of the Pres-

sure alarm to a value near the set pressure for ventilation (PEEP/CPAP + P_{insp}/P_{supp}port). When excessive leaks are present, the ventilator may not be able to reach the set pressure, and generates an alarm.

7.10 Working with ASV

To set up the ventilator using ASV

1. Open the Modes window and touch **ASV**, then touch **Continue**.
2. Set the controls as appropriate:
 - %MinVol: Set a value that results in the same minute volume as a previous mode, if applicable.
 - PEEP, Oxygen, Trigger, ETS, P-ramp: Set according to clinical requirements and the patient condition.
3. Review and adjust alarm limits.
 - Set the high Pressure alarm limit to an appropriate value.
 - The maximum peak pressure delivered in ASV (P ASV limit) is 10 cmH₂O below the high Pressure alarm limit or equal to the upper P ASV limit setting.
 - The maximum peak pressure for ASV can be also set using the P ASV limit control in the Controls window.
 - Changing the P ASV limit value also changes the high Pressure limit.
4. Connect the patient to the ventilator and start ventilation.

The ventilator initiates three test breaths.

The device automatically selects the values for respiratory rate (fTotal), inspiratory time (TI), and inspiratory pressure (P_{insp}) based on the calculated IBW and as specified in Table 7-3.

7.10.1 Clinical workflow with ASV

Figure 7-16 provides an overview of the ASV clinical workflow.

For technical specifications, see Section 16.9.

Figure 7-16. Clinical use of ASV

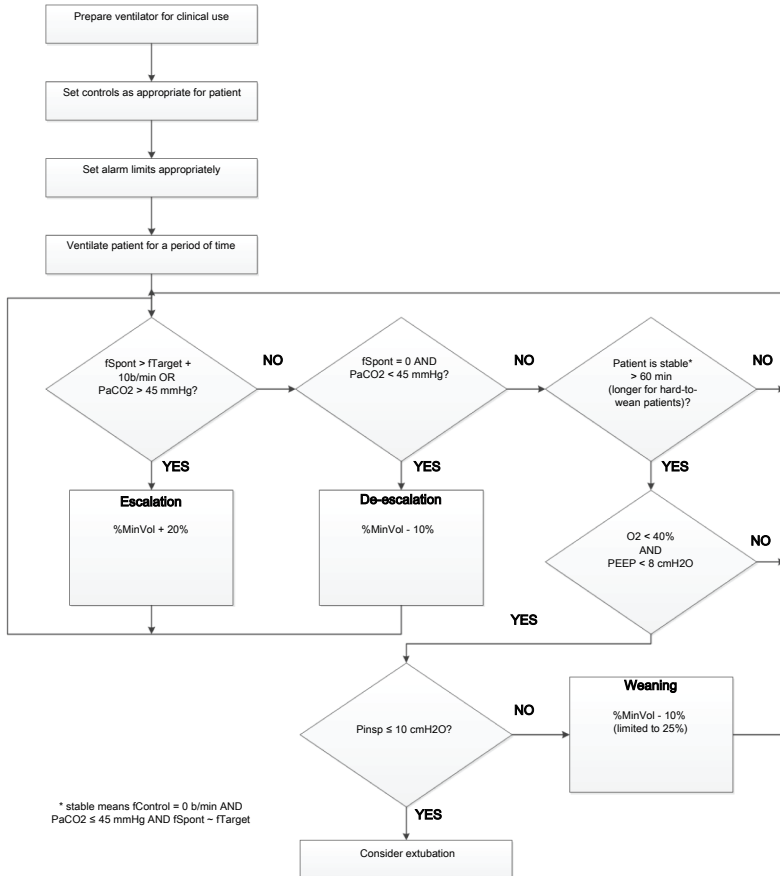

7.10.2 Maintaining adequate ventilation

WARNING

To change the minute volume setting, always use the %MinVol control. Do *not* manipulate the patient height setting to achieve the desired IBW to control minute volume.

Once ASV is started, the ventilator calculates an optimal breath pattern and associated target values for tidal volume and rate according to the rules in ASV and the set %MinVol to achieve the targets. Depending on whether the patient is passive or actively breathing, the ventilator delivers pressure-controlled or pressure-supported breaths in compliance with a lung-protective strategy. For details, see Section 7.10.6.4.

Once the calculated targets are reached, the result of the ventilation needs to be assessed. All monitored parameters can be used for this purpose. However, to assess respiratory acid-base status, it is recommended that arterial blood gases be measured and minute ventilation be adjusted accordingly. Table 7-4 provides examples of how to adjust the %MinVol setting.

Table 7-4. Blood gas and patient conditions and possible adjustments for ASV

Condition	%MinVol change
Normal arterial blood gases	None
High PetCO ₂ or PaCO ₂	Increase %MinVol Pay attention to inspiratory pressures
Low PaCO ₂	Decrease %MinVol Pay attention to mean pressures and oxygenation status
High respiratory drive	Consider increase in %MinVol Consider sedation, analgesia, or other treatments
Low O ₂ saturation	None Consider increase in PEEP/CPAP and/or Oxygen

7.10.3 Reviewing alarm settings

It is *not* possible to select a %MinVol that is incompatible with the lung-protective rules that govern ASV (for a detailed description, see Section 7.10.6.4). As a consequence, ASV tries to achieve the maximum possible ventilation and activates the ASV: Cannot meet target alarm.

Figure 7-17. Example of high %MinVol setting incompatible with the lung-protective rules strategy

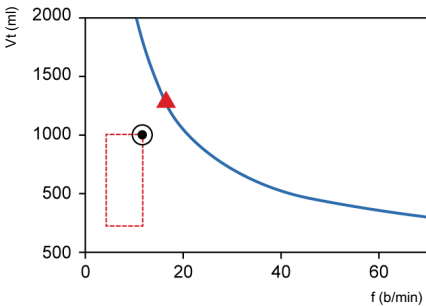

7.10.4 Monitoring ASV

ASV interacts with the patient continuously. Whenever the patient's respiratory mechanics change, ASV adjusts to this change. Whenever the patient's breathing activity changes, ASV adjusts the settings.

The ASV graph, shown in Figure 7-18, provides a real-time graphical view of the patient status relative to the set target. For details about the graph, see Section 8.4.3.

For details on displaying the ASV graph and ASV monitoring values, see Section 8.4.

To monitor progress over time, it is recommended that you plot trends for P_{insp}, f_{Total}, and f_{Spont}. Review these trends, together with the %MinVol setting to gain

insight into the patient's ventilatory status. Table 7-5 provides interpretations of typical ventilatory patterns.

Figure 7-18. ASV Graph panel

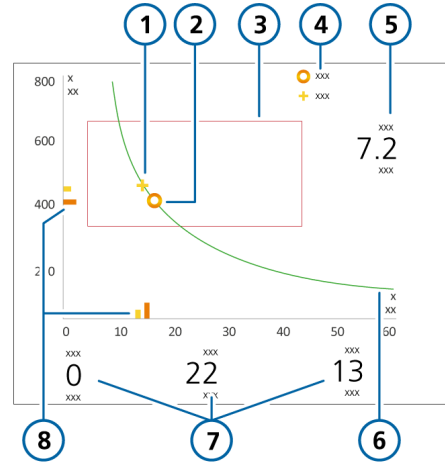

- | | | | |
|---|--|---|---|
| 1 | Current measured point: Intersection of measured tidal volume and rate | 5 | Target minute volume |
| 2 | Target point: Intersection of target tidal volume and target rate | 6 | Minute volume curve |
| 3 | Safety frame | 7 | P _{insp} : Inspiratory pressure set by ventilator
fControl: Machine rate
fSpont: Spontaneous breath rate |
| 4 | Legend | 8 | Current measured point (in yellow) and target value (in orange) |

7.10.5 Weaning

Weaning patients from the ventilator is a clinical task that requires experience and involves more than just ventilation issues. This section does not intend to provide clinical information other than that needed to operate the ventilator with ASV.

ASV always allows patients to take spontaneous breaths. Episodes of spontaneous breathing can occur and are supported by ASV even within a period of fully controlled ventilation. In other words, weaning can start with ASV so early that it may go unrecognized clinically. It is therefore important to monitor the spontaneous efforts of the patient over time.

The weaning progress can be monitored in the trends display when inspiratory pressure (**P_{insp}**), total rate (**f_{Total}**), and spontaneous rate (**f_{Spont}**) are plotted.

It may be necessary to reduce the **%MinVol** setting to 70% or even lower to “motivate” the patient to resume spontaneous breathing. If a patient can sustain minutes or even hours with a low **%MinVol** setting, it does not mean that weaning is complete. In fact, the **%MinVol** setting must always be interpreted in conjunction with the level of **P_{insp}** needed to achieve the set minute ventilation. Only if **P_{insp}** and **f_{Control}** are at their minimum values can weaning be assumed to be complete.

Table 7-5. Interpretation of breathing pattern at lower than 100 %MinVol setting

P_{insp}	f_{Control}	f_{Spont}	Interpretation
> 10	> 10	0	Danger of hypoventilation. Check arterial blood gases and consider increasing %MinVol .
> 10	0	Acceptable	Enforced weaning pattern. Check arterial blood gases and patient respiratory effort. Consider decreasing or increasing %MinVol accordingly.
< 8	0	Acceptable	<i>Unsupported breathing</i> . Consider extubation.
> 10	0	High	Dyspnea. Consider increasing %MinVol and other clinical treatments. Check for autotriggering.

7.10.6 Functional overview

The following sections provide a brief overview of how ASV manages ventilation.

7.10.6.1 Normal minute ventilation

ASV defines normal minute ventilation according to the graph in Figure 7-19.

Figure 7-19. Normal minute ventilation as a function of ideal body weight (IBW)

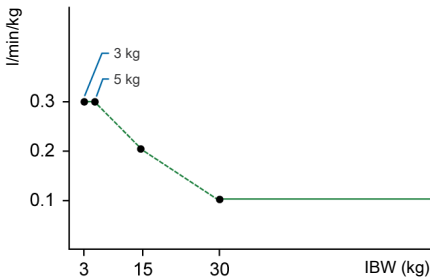

For patients with an IBW ≥ 30 kg, minute ventilation is calculated as $0.1 \text{ l/kg} * \text{IBW}$ (solid line). For patients with an IBW < 30 kg, the value is indicated by the dotted line.

Minute ventilation for a 15 kg patient is calculated as

$$0.2 \text{ l/kg} * 15 \text{ kg} = 3 \text{ l/min}$$

For example, for an IBW of 70 kg, normal minute ventilation corresponds to 7 l/min.

7.10.6.2 Compensation for changes in apparatus dead space

Dead space is calculated as 2.2 ml per kg. This dead space is a nominal value that is valid, on average, for intubated patients whose endotracheal tube is connected to the Y-piece of the ventilator by a standard catheter mount.

Changes in alveolar dead space due to ventilation/perfusion mismatch must be compensated using the %MinVol control.

If this dead space is altered by an artificial airway configuration, such as the use of a heat and moisture exchanging filter (HMEF) or nonstandard tubing, modify the %MinVol setting to take into account the added or removed dead space.

7.10.6.3 Targeted minute ventilation

When you choose ASV, you must select an appropriate minute ventilation for the patient. Minute ventilation is set with the %MinVol control, which, together with the patient height, determines the total minute ventilation in liters per minute.

A %MinVol setting of 100% corresponds to a normal minute ventilation (Section 7.10.6.1). A setting below or above 100% corresponds to a minute ventilation lower or higher than normal.

From the %MinVol, the target minute ventilation (in l/min) is calculated as:

$$\text{Ideal body weight (in kg)} \times \text{NormMinVent (in l/kg/min)} \times (\% \text{MinVol}/100)$$

where NormMinVent is the normal minute ventilation. See Figure 7-19.

For example, with a %MinVol = 100 and an IBW = 70 kg, a target MinVol of 7 l/min is calculated. This target can be achieved with a number of combinations of tidal

volume (V_t) and respiratory rate (f). This is shown in Figure 7-20, where all possible combinations of V_t and f lie on the bold line, the target minute volume curve.

Figure 7-20. MinVol = 7 l/min

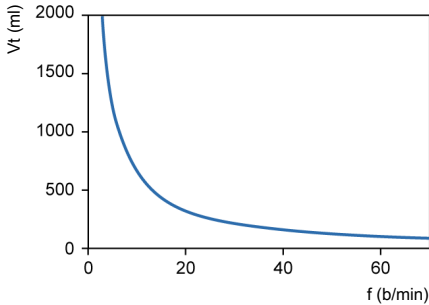

7.10.6.4 Lung-protective strategy

Not all combinations of V_t and f shown in Figure 7-20 are safe for the patient. The high tidal volumes will overdistend the lungs and the small tidal volumes cannot produce alveolar ventilation at all.

Another risk lies in inadequate respiratory rates. High rates can lead to dynamic hyperinflation or breath stacking, and thus inadvertent PEEP. Low rates can lead to hypoventilation and apnea. Therefore, it is necessary to limit the number of possible combinations of V_t and f .

When limits are imposed on the possible combinations of V_t and f , ASV uses a double strategy:

- The operator input for ASV determines the absolute boundaries.
- Internal calculations based on patient measurements further narrow the limits to counteract possible operator errors and to follow changes of respiratory system mechanics.

The effect of the strategy is shown in Figure 7-21 and explained in the subsequent sections.

Figure 7-21. Lung-protective rules strategy

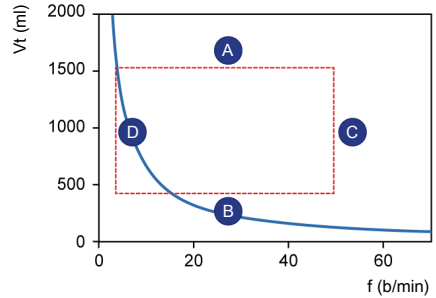

A: High tidal volume limit

The tidal volume applied by ASV is limited (see A in Figure 7-21) by three operator settings: high Pressure alarm limit, high V_t alarm limit, and patient height.

Note the following:

- You must set the high Pressure limit before connecting a patient to the ventilator. The maximum pressure applied in the ASV mode is 10 cmH₂O below the high Pressure alarm limit.
- Additionally, the target volume is limited to 150% of the high V_t alarm limit, and pressure support is limited such that the inspired volume does not exceed the high V_t alarm limit in mechanical breaths for more than a few breaths.
- If you set the Pressure alarm limit to a very high pressure, say 60 cmH₂O, the target volume is limited by the second criterion: 15 ml/kg.
- Check the V_t high setting to make sure the target minute ventilation can be reached in passive patients.

B: Low tidal volume limit

You must use caution with low tidal volumes to avoid insufficient alveolar ventilation.

The determining parameter for alveolar ventilation is dead space (VD_{aw}). Tidal volume value must always be greater than the VD_{aw} value. It is widely accepted that a first approximation of dead space can be obtained by the following simple equation (Radford 1954):

$$VD_{aw} = 2.2 * IBW$$

ASV calculates the lower limit for tidal volume based on the following equation: $IBW * 4.4 \text{ ml/kg}$. The multiplying factor is calculated to be at least twice the dead space.

C: High rate limit

You derive the maximum rate (C in Figure 7-21) from the operator-set %MinVol and the calculated IBW, which is calculated from the operator-set patient height. The equation used to calculate the maximum rate is:

$$f_{max} = \text{target MinVol} / \text{minimum } V_t$$

However, if you choose an excessively high %MinVol of 350%, the maximum rate becomes 77 b/min. To protect the patient against such high rates, ASV employs a further safety mechanism, which takes into account the patient's ability to exhale.

A measure of the ability to exhale is the expiratory time constant (RC_{exp}). To achieve a nearly complete exhalation to the equilibrium point of the respiratory system (90% of the maximum potential volume change), an expiratory time of at least $2 * RC_{exp}$ is theoretically required.

For this reason, ASV calculates the maximum rate based on the principle of giving a minimum inspiratory time equal to $1 * RC_{exp}$ and a minimum expiratory time equal to $2 * RC_{exp}$, which results in these equations:

$$f_{max} = 60 / (3 * RC_{exp}) = 20 / RC_{exp}$$

$$f_{max} \leq 60 \text{ b/min}$$

This limit applies to the respiratory rate of the ventilator only, *not* to the respiratory rate of the patient.

D: Low rate limit

The lowest target rate (see D in Figure 7-21) is predefined according to the IBW. See Table 7-3.

7.10.6.5 Optimal breath pattern

Although the lung-protective rules strategy limits possible combinations of V_t and f , ASV prescribes an explicit target combination. Using the example in Figure 7-21, this shows considerable room for selection within the dotted rectangle. The selection process is an exclusive feature of ASV.

The device works on the assumption that the optimal breath pattern is identical to the one a totally unsupported patient will choose naturally (assuming the patient is capable of maintaining the pattern).

It is common knowledge that the choice of breathing pattern is governed by either work of breathing or the force needed to maintain a pattern. ASV calculates the optimal rate based on the operator-set %MinVol and the calculated IBW, as well as on the measurement of RC_{exp} (Section 7.6.1).

Once the optimal rate is determined, the target V_t is calculated as follows:

$$V_t = \text{target MinVol} / \text{optimal rate}$$

Figure 7-22 shows the position of the target breathing pattern as well as the safety limits imposed by the lung-protective rules strategy. The rectangle shows the safety limits; the circle shows the target breath pattern.

Figure 7-22. Anatomy of the ASV target graphics window

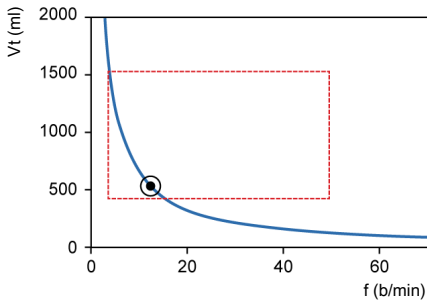

7.10.6.6 Initial breaths: How ASV starts

How do you achieve the target values for a given patient if you do not know whether or not the patient can breathe spontaneously? For this purpose, ASV uses a predefined rate according to the calculated IBW. For more information see Table 7-3.

Patient-triggered breaths are pressure supported and flow cycled, or, the transition to exhalation is made based on Intelli-Sync+, if selected. If the patient does not trigger the breath, the delivery of the breath is with a preset pressure and time cycled.

The following controls are operator-set (manual):

- PEEP/CPAP
- Oxygen
- P-ramp
- ETS
- Trigger type and sensitivity

This list of controls is adjusted automatically by ASV, and cannot be adjusted by the operator:

- Mandatory breath rate: to change total respiratory rate
- Inspiratory pressure level: to change inspiratory volume
- Inspiratory time: to allow gas flow into the lungs
- Startup breath pattern

To safely start ASV, you set the Patient height (Pat. height) and sex, which are then used to calculate the IBW.

Upon starting ventilation, three initial test breaths are delivered. The resulting rate and tidal volume are measured and compared with the target values. ASV then responds to the differences between the current and target tidal volumes, as well as the current and target rates.

7.10.6.7 Approaching the target

Figure 7-23 shows a possible scenario after the three initial test breaths. The current breath pattern, which is plotted as the patient symbol, shows clear deviation from the target. ASV's task is to move the patient symbol as close to the circle as possible.

Figure 7-23. Example after three initial breaths

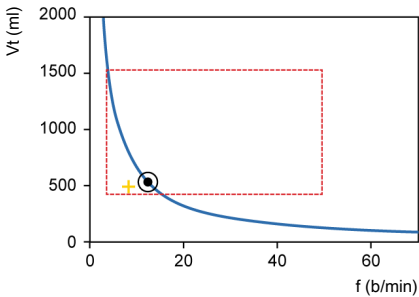

The patient symbol marks the actual measured value for V_t and Rate.

To achieve the target, ASV uses the following strategy:

- If actual V_t < target V_t , the inspiratory pressure is increased.
- If actual V_t > target V_t , the inspiratory pressure is decreased.
- If actual V_t = target V_t , the inspiratory pressure is left unchanged.
- If actual rate < target rate, the fControl rate is increased.
- If actual rate > target rate, the fControl rate is decreased.
- If actual rate = target rate, the fControl rate is left unchanged.

As a result, the patient symbol in Figure 7-23 moves toward the circle. The current V_t is calculated as the average of inspiratory and expiratory volumes. This definition compensates in parts for leaks in the breathing circuit, including the endotracheal tube.

7.10.6.8 Dynamic adjustment of lung protection

The operator preset values are not changed by ASV, and the corresponding safety limits remain as defined in the previous sections. However, if the respiratory system mechanics change, the safety limits change accordingly, as defined in Section 7.10.6.4. The safety limits are updated on a breath-by-breath basis.

For example, if the lungs stiffen, the high V_t limit is lowered proportionally, and the high rate limit is increased.

This dynamic adjustment ensures that ASV applies a safe breathing pattern at all times. In graphical terms, the dotted rectangle changes as shown in Figure 7-24.

Figure 7-24. Lung-protective limits

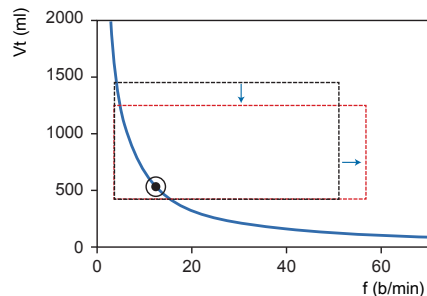

Lung-protective limits are changed dynamically and according to the respiratory system mechanics.

However, the limits set by the operator are never violated.

7.10.6.9 Dynamic adjustment of optimal breath pattern

After it is calculated, the optimal breath pattern is revised with each breath according to the **RC_{exp}** measurements. A new target breathing pattern is calculated using ASV algorithms. The targets do not change under steady-state conditions. However, if the patient's respiratory system mechanics change, the target values also change.

8

Monitoring ventilation

8.1	Overview.....	154
8.2	Viewing numeric patient data	154
8.3	Viewing graphical patient data	156
8.4	Working with Intelligent panels	165
8.5	Monitoring transpulmonary/esophageal pressure	171
8.6	About the monitored parameters	172
8.7	Viewing patient ventilation time	182
8.8	Viewing device-specific information	182

8.1 Overview

You can configure how to view patient data during ventilation, including displaying waveforms, loops, trends, and Intelligent Panel graphics to suit your institution's needs (Figure 8-1).

Data is also available in the Monitoring window, which you can access at any time without affecting breath delivery.

For the list of monitored parameters, see Section 8.6.

Figure 8-1. Main display

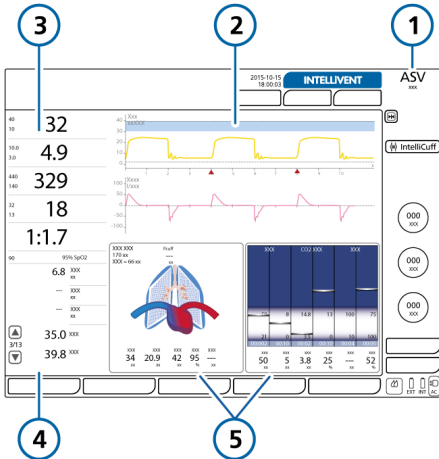

- 1 Current mode
- 2 Full-screen waveforms
- 3 Main monitoring parameters (MMP) (Section 8.2.1)
- 4 Secondary monitoring parameters (SMP) (Section 8.2.2)
- 5 Graphic display, configurable (Section 8.3)

8.2 Viewing numeric patient data

Numeric patient data is readily available as follows:

- The main display prominently shows the configured main monitoring parameters (MMPs). See Section 8.2.1.
- The main display shows additional sets of parameters under the MMPs, referred to as the *secondary monitoring parameters* (SMPs). See Section 8.2.2.
- The Monitoring window provides access to all of the parameter data. See Section 8.2.3.

8.2.1 About the main monitoring parameters (MMP)

The MMPs are the numerical monitoring parameters shown on the left side of the display. Every displayed parameter shows the following elements: the current value, name, and unit of the monitoring parameter, and the set alarm limits, when applicable.

The MMPs that are displayed, as well as their sequence on the display, can be changed in Configuration (Chapter 14). Any of the monitored parameters can be displayed as an MMP. As a result, MMPs may differ between individual ventilators.

An MMP is normally displayed in white. When directly related to an active alarm, the MMP is shown in yellow or red, corresponding to the alarm priority. After the alarm resets, the affected MMP returns to white.

Figure 8-2. MMP and SMP components

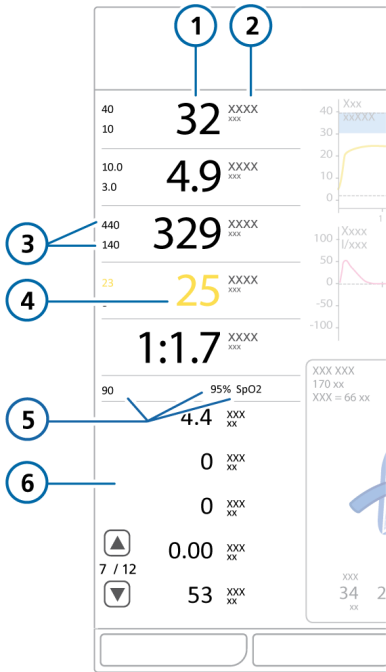

- | | | | |
|---|--------------------------|---|--|
| 1 | MMP value | 4 | Parameter associated with active alarm |
| 2 | Parameter name/units | 5 | SpO2 lower alarm limit, SpO2 value* |
| 3 | Upper/lower alarm limits | 6 | SMP view |

* If SpO2 sensor is enabled and connected

8.2.2 About the secondary monitoring parameters (SMPs)

Additional data, referred to as secondary monitoring parameters (SMPs), is displayed under the MMPs, organized into a series of views, each displaying a group of parameters. You cycle through the views using the navigation arrows.

Figure 8-3. Monitoring panel for SMPs (1)

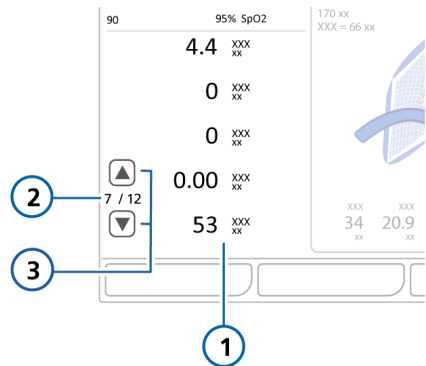

- | | | | |
|---|---------------------------------|---|------------------------|
| 1 | Secondary monitoring parameters | 3 | View navigation arrows |
| 2 | Current view | | |

To navigate the SMP views

- ▶ Touch the up and down navigation arrows to cycle through the SMP views (Figure 8-3).

8.2.3 Viewing patient data in the Monitoring window

The Monitoring window provides access to monitored parameter data as follows:

- The **1** tab (Figure 8-4) provides access to ventilation parameter values.
- The **2** tab provides access to CO₂-, SpO₂-, and Pes (Paux)-related parameter values.
- When using two SpO₂ sensors, the **SpO₂raw** tab provides access to raw SpO₂ data and signal quality information.
- The **Paw/Paux** tab allows you to activate **Paux** as the standard pressure input. For details, see Section 3.5.

Figure 8-4. Monitoring > 1 window

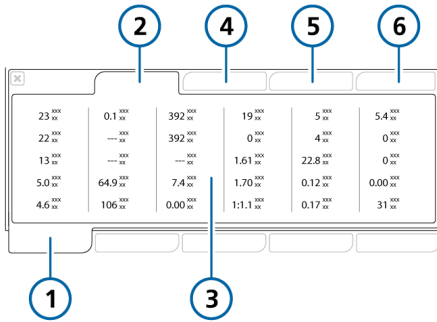

- | | |
|--------------------|--|
| 1 Monitoring | 4 2 tab |
| 2 1 tab | 5 SpO ₂ raw ²⁹
(if enabled) |
| 3 Parameter values | 6 Paw/Paux |

To display the Monitoring window

1. Touch the **Monitoring** button.
2. If not already displayed, touch the **1** tab.

8.3 Viewing graphical patient data

In addition to numerical data, the HAMILTON-S1 shows user-selectable graphical views of real-time patient data (Table 8-1).

The ventilator offers multiple views of this data, and, within preconfigured layouts, allows you to select what to display and where. You choose a layout to show your desired combination of full- and half-screen waveforms, graphics, and informational panels.

You can change individual elements, as well as the display layout, at any time.

²⁹ Available only when using two SpO₂ sensors.

Table 8-1. Graphical view options



Graphic type	Options	
Waveforms (Data values plotted against time)	<ul style="list-style-type: none"> • Paw • Flow • Volume • Off 	<ul style="list-style-type: none"> • PCO₂³⁰ • FCO₂³⁰ • Plethysmogram³¹ • Pes (Paux)³² • Ptranspulm³²
Graphics (Intelligent panels)	<ul style="list-style-type: none"> • Dynamic Lung³³ • Vent Status 	<ul style="list-style-type: none"> • ASV Graph³⁴ • ASV Monitor³⁴
Trends	1-, 3-, 12-, 24-, or 96-h trend data for a selected parameter or combination of parameters	
Loops	<ul style="list-style-type: none"> • Paw/Vol-ume • Paw/Flow 	<ul style="list-style-type: none"> • Flow/Vol-ume • Volume/PCO₂³⁰
You can also choose to display any combination of the following parameters as a loop: Paw, Flow, Volume, Pes (Paux) ³² , Paw/Pes (Paux) ³² , PCO ₂ , FCO ₂		

8.3.1 Selecting a display layout

While you can select a layout and the graphics to display, you can also revert back to the default layout at any time.

Table 8-2 describes the layout options.

Table 8-2. Graphic layout options

	<i>Layout 1.</i> Four full-screen waveforms
	<i>Layout 2.</i> Two full-screen waveforms and any combination of graphic panels and half-screen waveforms
	<i>Layout 3.</i> Any combination of half-screen waveforms and graphic panels

The graphic choices you make for a selected layout are saved for the current patient until you manually change them. When setting up a new patient, each layout reverts to the default graphics specified in the system default for the selected patient group.

Tip. When setting up a new patient, you can individually set up Layouts 1, 2, and 3 with your preferred graphics, and then later quickly switch between these views at any time by selecting the desired layout in the Graphics window.

³⁰ CO₂ option required.

³¹ SpO₂ option required.

³² Data is available only when an esophageal catheter is connected to the Pes port on the ventilator.

³³ Only for adult/pediatric patients.

³⁴ Only in ASV mode.

To change the layout of the display

1. Touch the **Graphics** button (Figure 8-5).
2. Touch the desired layout option.
To revert to the default layout configuration, touch **Restore**.

The window closes automatically, and the display adjusts to the new selection.

Figure 8-5. Graphics window

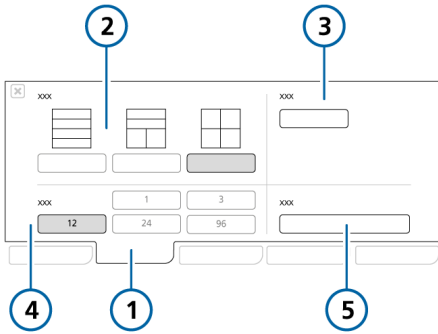

- | | |
|-------------------|----------------|
| 1 Graphics | 4 Trend timing |
| 2 Layouts 1, 2, 3 | 5 Restore |
| 3 Time scale | |

8.3.2 Selecting display options

You can change the graphics at any time.

To change the contents of a graphic panel or waveform

1. Touch the area of the display to change.

The selected panel is highlighted in yellow.

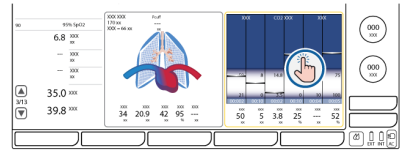

The graphics selection window appears, displaying the current selection (Figure 8-6).

2. Select the desired option from the list using the P&T knob.

The options are Trend, Loop, Waveform, Dynamic Lung, Vent Status, ASV Graph, and ASV Monitor.

After making a selection, the window closes automatically, and the display adjusts to the new selection.

Figure 8-6. Graphics selection list (1)

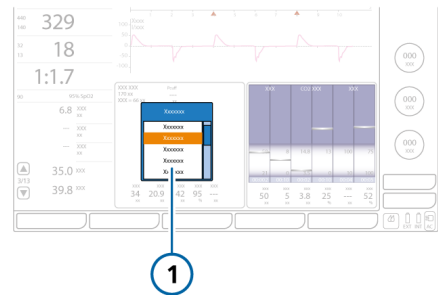

8.3.3 Working with waveforms

The ventilator can plot pressure, volume, and flow against time, in addition to other data as listed in Table 8-1.

8.3.3.1 Waveform views

You can show one or more waveforms on the display, depending on which layout option you select.

Table 8-3. Waveform layout options

Layout 1. Up to four full-screen waveforms

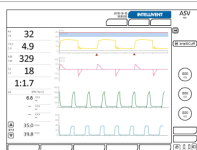

Layout 2. Up to two full-screen waveforms and two or more half-screen waveforms

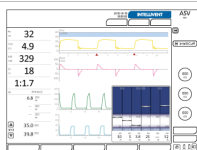

Layout 3. A combination of two or more half-screen waveforms and graphic panels

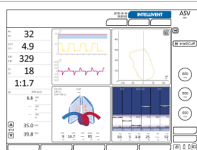

8.3.3.2 Displaying waveforms

You select waveforms directly on the display.

To add or change a full-screen waveform

1. Touch the waveform to change (Section 8.3.2).

The Waveform list opens, displaying available options (Table 8-1).

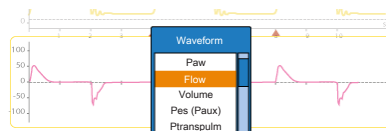

2. Use the P&T knob to find and select the desired option.

The selected waveform is displayed, using the timescale specified in the Graphics window (Figure 8-5).

To add or change a half-screen waveform

1. Touch the graphic panel or waveform to change.

The Graphic list opens, displaying available panel options (Table 8-1).

2. Use the P&T knob to highlight and select **Waveform**.

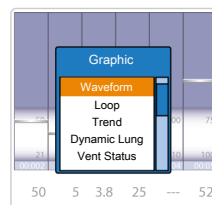

The Upper waveform list opens.

3. Highlight and select the desired option for the top waveform.

The Lower waveform list opens.

4. Highlight and select the desired option for the bottom waveform.

The selected waveforms are displayed, using the timescale specified in the Graphics window (Section 8.3.3.4).

8.3.3.3 About the Pressure/time (Paw) graph

By default, the Pressure/time (Paw) graph is shown at the top of the display.

In APV, VS, and ASV modes, the ventilator uses the high Pressure alarm setting minus 10 cmH₂O as a safety boundary for its inspiratory pressure adjustment, and does not exceed this value.

The blue pressure limit line shows the maximum pressure that the ventilator will apply, which is 10 cmH₂O below the set high Pressure alarm setting. The high Pressure alarm setting is shown as a red line.

Figure 8-7. Pressure/time graph

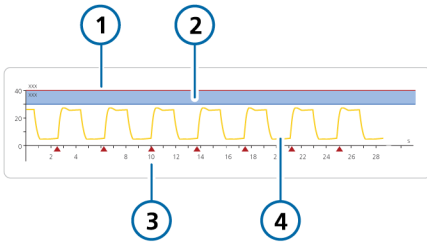

- | | |
|--|----------------------------------|
| 1 High Pressure alarm limit | 3 Patient trigger indicator |
| 2 Pressure limitation: high Pressure alarm limit – 10 cmH ₂ O | 4 Airway pressure (Paw) waveform |

When TRC is enabled, the tracheal pressure (Ptrach) waveform (orange) is shown together with the Paw waveform (yellow). See Section 5.5.4.

8.3.3.4 Changing the waveform scaling

Scaling refers to the values of the x- and y-axis of a waveform or a loop. In the waveforms displayed on the ventilator, the x-axis represents time, while the y-axis can represent a variety of parameters, including pressure, flow, or volume.

The HAMILTON-S1 supports automated scaling (the default) and manual scaling.

Autoscaling

When autoscaling is activated, the ventilator automatically optimizes the scale based on the breath rate. For example, if the patient is breathing rapidly, the ventilator automatically shortens the graph time scale to ensure a clean, readable graph.

Note that, as a result of optimization, the scales used for individual waveforms on the display may differ.

Manual scaling

With manual scaling, you set the desired time scale in the Graphics window, and the desired y-axis values in the individual scaling lists. The selected time scale applies to all of the displayed waveforms.

The HAMILTON-S1 offers the following time scale options, in seconds: Auto, 5, 10, 20, 30, 60

The y-axis scaling options depend on the parameter being graphed. For details, see Table 16-7.

To change the time scale (x-axis)

1. Touch the **Graphics** button (Figure 8-5).
2. Touch the button in the **Time scale** section.
The Time scale list appears.
3. Use the P&T knob to find and select the desired time scale, pressing the P&T knob to confirm the selection.
To set the time scale automatically, select **Auto**.

The time scale button changes to the name of your selection (**Auto** or the selected time). Your selection applies to all displayed waveforms.

To change the parameter scale (y-axis)

1. Touch the y-axis of the waveform to change.
The list of positive scaling values appears.



2. Use the P&T knob to find and select the desired value interval, pressing the P&T knob to confirm the selection.
To set the interval automatically, select **Auto**.
3. If the negative scaling list is displayed, use the P&T knob to find and select the desired value interval.

Once confirmed, the list closes and the waveform is updated.

8.3.3.5 Freezing and reviewing waveforms and trends

You can independently freeze the display of waveforms and trends for a short period of time. After 120 seconds of inactivity, the frozen elements are automatically unfrozen.

When waveform freeze is enabled (Figure 8-8), all of the displayed waveforms are frozen, allowing you to scroll through them for a detailed review. The Freeze function is time-synced across the displayed waveforms.

If one or more Trend graphs are displayed, the **Trend** freeze button is available (Figure 8-9), allowing you to scroll through the trends for a detailed review.

The Freeze function is particularly useful when you perform a breath hold maneuver. The display automatically freezes following a successful inspiratory or expiratory hold maneuver.

To freeze waveforms

1. Touch the waveform **Freeze** button (Figure 8-8).
The displayed waveform/Trend graphs are frozen and cursor bars are displayed.
2. To scroll through the graphics for analysis, turn the P&T knob clockwise or counter-clockwise.
The cursor bars move to the right and to the left.
3. To unfreeze the display and return to displaying real-time data, touch the **Freeze** button again or press the P&T knob.

Figure 8-8. Freezing waveforms

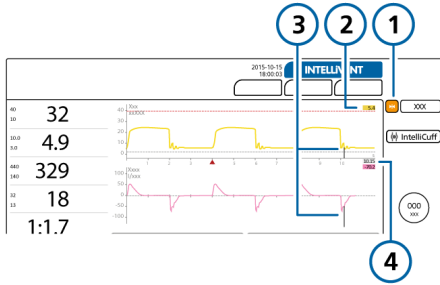

- | | |
|---|-------------------------------|
| 1 Freeze button
(for waveforms) | 3 Cursor |
| 2 Value at cursor
(in yellow and in
pink) | 4 Time at cursor
(in gray) |

To freeze trends

1. Touch the **Trend** freeze button (Figure 8-9).

The displayed waveform/Trend graphs are frozen and cursor bars are displayed.

2. To scroll through the graphics for analysis, turn the P&T knob clockwise or counter-clockwise.

The cursor bars move to the right and to the left.

3. To unfreeze the display and return to displaying real-time data, touch the **Freeze** button again or press the P&T knob.

Figure 8-9. Freezing trends

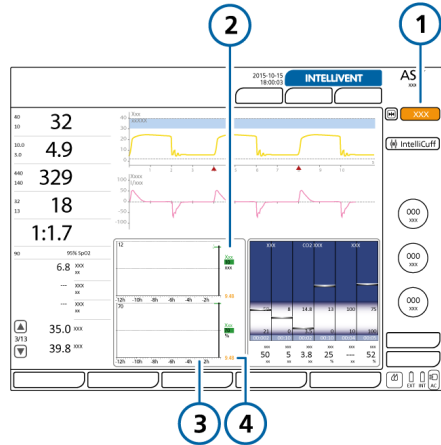

- | | |
|----------------------------|---|
| 1 Freeze trend but-
ton | 3 Elapsed time rela-
tive to present |
| 2 Value at cursor | 4 Time at cursor |

8.3.4 Working with Trend graphs

Trend data includes all data since the ventilator was turned on for a selected parameter for the past 1, 3, 12, 24, or 96 hours.

Figure 8-10. Trend panel

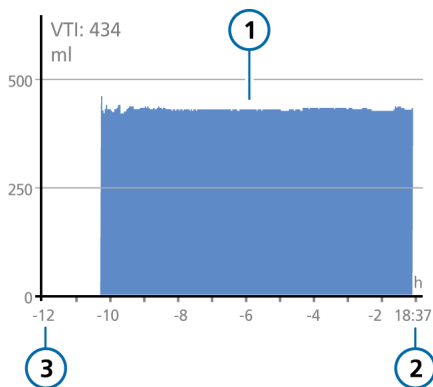

- | | |
|----------------|------------------------------------|
| 1 Trend graph | 3 Elapsed time relative to present |
| 2 Current time | |

From the time the ventilator is turned on, it continuously stores up to 96 hours of monitored parameter data in its memory, including when in Standby.

You can also freeze Trend graphs and examine them more closely. When trends are frozen, the panel shows the time and the corresponding value of the monitored parameter. For details about freezing and reviewing Trend graphs, see Section 8.3.3.5.

Most monitoring parameters can be trended. The following parameters are trended in combination: Ppeak/Pmean/PEEP, ExpMinVol/MVSpont, fTotal/fControl, ExpMinVol/fSpont/Pinsp, and SpO2/PEEP/Oxygen, VDaw/VTE/Vtalv, PetCO2/ExpMinVol, and SpO2/FiO2 (if supported on your device).

8.3.4.1 Displaying trends

Trend graphs can be displayed using graphic layouts 2 and 3 (Table 8-2). They are displayed as a set of two graphs, one above the other.

To display trends

1. Touch the area of the display where you wish to show a trend graph (Section 8.3.2).
The Graphic selection list opens, displaying available panel options.
2. Use the P&T knob to highlight and select **Trend**.
The **Upper** trend list opens.
3. Highlight and select the desired option for the top trend.
The **Lower** trend list opens.
4. Highlight and select the desired option for the bottom trend.

The selected trend information is displayed (Figure 8-10).

8.3.5 Working with loops

The HAMILTON-S1 can display a dynamic loop based on the parameter combinations listed in Table 8-1.

Figure 8-11. Loops panel, Flow/Volume loop displayed

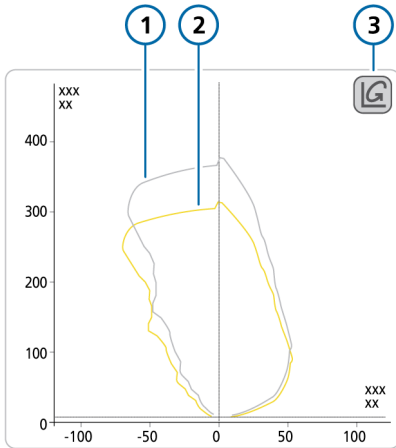

- 1 Stored reference loop
- 2 Current loop
- 3 Loop reference button

8.3.5.1 Displaying loops

To display loops

1. Touch the area of the display where you wish to show a loop (Section 8.3.2).
The Graphic selection list opens, displaying available panel options.
2. Use the P&T knob to highlight and select **Loop**.
3. Highlight and select the desired option to display.

The selected parameter is displayed (Figure 8-11).

8.3.5.2 Storing loops

You can store a loop to use as a reference, for comparison purposes.

To store a new loop

- ▶ In the Loop display (Figure 8-11), touch the **Loop reference** button to store the loop curve with the current date and time.

The previous and current characteristics are shown. Any previously stored loop is discarded.

8.4 Working with Intelligent panels

You can set up the ventilator display to show any of the Intelligent panels:

- Dynamic Lung
- Vent Status
- ASV Graph
- ASV Monitor

The Intelligent panels are all displayed using the graphics selection list.

8.4.1 Dynamic Lung panel: real-time ventilation status

The Dynamic Lung³⁵ shows an up-to-date visual representation of key ventilation data (Figure 8-12).

In addition to the graphic representation, the panel shows numeric data for key parameters. If all values are in a normal range, the panel is framed in green.

The Dynamic Lung comprises the following components:

- Mechanical breath
- Respiratory compliance
- Airway resistance
- Patient triggering
- SpO₂ data (if installed and enabled)
- IntelliCuff data (if connected and active)

Figure 8-12. Dynamic Lung panel

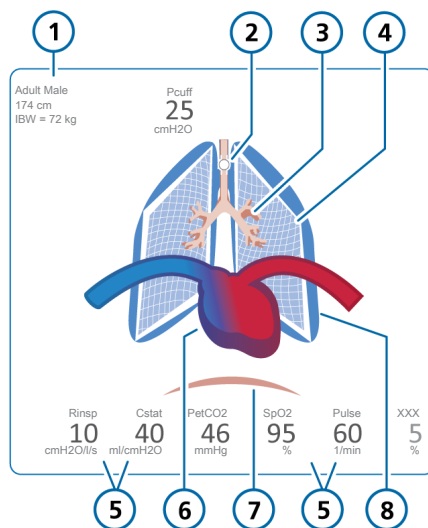

- | | |
|---------------------------------------|--|
| 1 Sex, height, IBW | 5 Monitored parameter values** |
| 2 Cuff indicator* | 6 Heart and pulse display*** |
| 3 Representation of airway resistance | 7 Patient trigger (diaphragm) |
| 4 Representation of lung compliance | 8 Representation of breaths and tidal volume |

* If IntelliCuff is connected and active

** Rinsp and Cstat can be turned on/off in Configuration. May include HLI (Nihon Kohden only, if displayed), PVI (Masimo only)

*** If SpO₂ sensor enabled and connected

³⁵ Only for adult/pediatric patients.

Mechanical breaths, with tidal volume

The mechanical breath is shown as a set of lungs that expand and contract in synchrony with ventilator breath delivery, showing the delivered tidal volume (V_t) in real-time. The lung size displayed is relative to the “normal” size for the patient’s height.

A Disconnection alarm is indicated by a deflated lung. An Exhalation obstructed alarm is indicated by an over-inflated lung.

The movement and shape of the lungs allows you to quickly verify that the ventilator is ventilating the patient and at which rate.

Respiratory compliance

Respiratory compliance is based on the C_{stat} parameter, which includes both lung and chest wall compliance. Compliance is illustrated by the contour lines of the lung, as shown in Figure 8-13. The numeric value is also shown.

Figure 8-13. Examples of lung compliance (C_{stat}) illustrated in Dynamic Lung

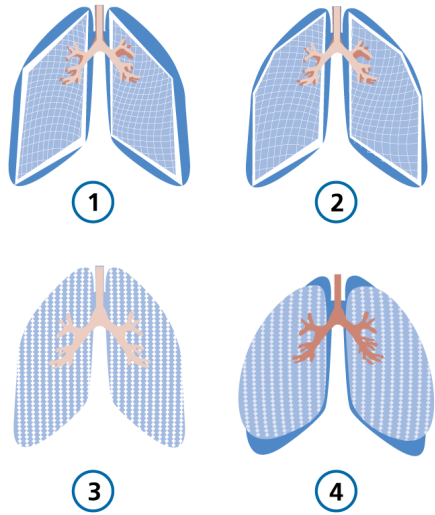

- | | |
|-----------------------|---------------------|
| 1 Very low compliance | 3 Normal compliance |
| 2 Low compliance | 4 High compliance |

Airway resistance

Airway resistance refers to the total resistance imposed by the patient's airway as well as the artificial airway, such as an endotracheal tube or tracheostomy tube. Airway resistance is illustrated by the size and color of the tracheobronchial tree, as shown in Figure 8-14.

Figure 8-14. Examples of resistance shown by the bronchial tree of the Dynamic Lung

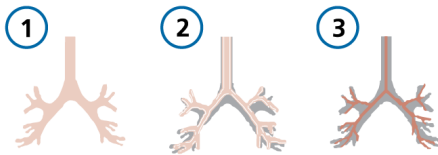

- 1 Normal resistance 3 High resistance
2 Moderately high resistance

Patient trigger

If a patient trigger is detected, an illustration of the diaphragmatic muscle appears briefly at the beginning of inspiration, as shown in Figure 8-15. This allows you to quickly see whether the breath is patient triggered.

Figure 8-15. Patient triggering (1) in Dynamic Lung

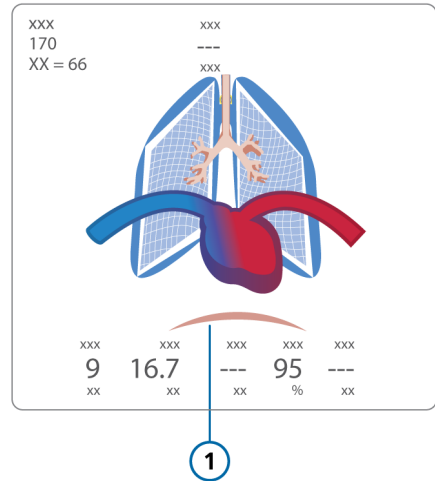

SpO2 data

If the SpO2 option is enabled and a sensor is connected, the Dynamic Lung panel shows a heart and big vessel illustration superimposed on the lungs. The heart beats in synchrony with the patient's pulse rate. See Figure 8-12. For details about SpO2 measurement, see the *Pulse Oximetry Instructions for Use*.

IntelliCuff data

When an IntelliCuff cuff pressure controller is connected to the ventilator, the Dynamic Lung displays the Pcuff parameter. When IntelliCuff is connected, turned on, and active, the Dynamic Lung also includes a cuff symbol in the bronchial tree (Figure 8-12); this symbol also indicates IntelliCuff-related alarm status (see Table 12-7).

8.4.1.1 Displaying the Dynamic Lung

The Dynamic Lung panel can be displayed in layouts 2 and 3 (Table 8-2).

To display the Dynamic Lung

1. Touch the area of the display where you wish to show the Dynamic Lung panel (Section 8.3.1).

A pop-up window opens showing the available display options.

2. Using the P&T knob, highlight and select **Dynamic Lung**.

The Dynamic Lung is displayed (Figure 8-16).

Figure 8-16. Dynamic Lung in display

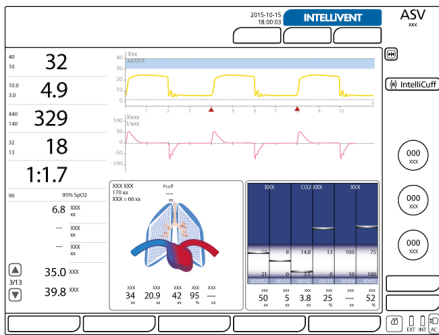

8.4.2 Vent Status panel: real-time ventilator dependence status

The Vent Status panel (Figure 8-17) displays six parameters related to the patient’s ventilator dependence, in the areas of oxygenation, CO2 elimination, and patient activity.

A floating indicator (floater) moving up and down within the column shows the value for a given parameter.

When the indicator is in the light blue (weaning) zone, a timer starts, showing how long that value has been in the weaning zone. When all values are in the weaning zone, the Vent Status panel is framed in green, indicating that weaning should be considered. A timer appears, recording the length of time all values have been in the weaning zone (Figure 8-17).

The panel is updated breath by breath.

Table 8-4 describes the parameters shown in the Vent Status panel.

You can configure the weaning zone ranges for these parameters in Configuration. To set the values, see Section 14.10.

Figure 8-17. Vent Status panel

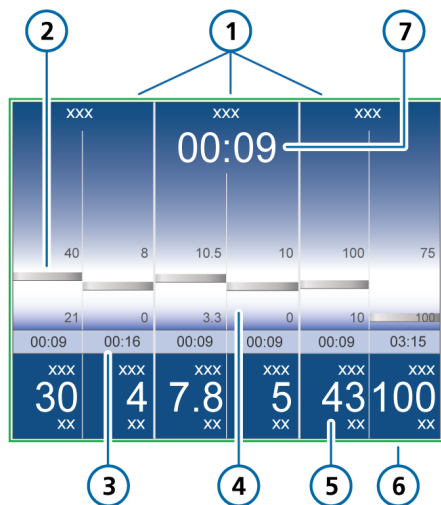

- | | |
|---|---|
| 1 Group title | 5 Monitored value, numeric |
| 2 Monitored value, graphic (floater) | 6 Green outline indicating all values are in the weaning zone |
| 3 Elapsed time value has been in weaning zone | 7 Elapsed time all values have been in weaning zone |
| 4 Weaning zone with user-configurable limits | |

Table 8-4. Vent Status parameters

Parameter (unit)	Definition
<i>For additional details, including ranges and accuracy, see Table 16-5.</i>	
Oxygen (%)	Oxygen setting.
PEEP (cmH2O)	PEEP/CPAP setting.

Parameter (unit)	Definition
MinVol (l/min)	Normal minute ventilation (see Section 7.10).
Pinsp (cmH2O)	Inspiratory pressure, the target pressure (additional to PEEP/CPAP) applied during the inspiratory phase.
RSB (1 / (l*min)) ³⁶	Rapid shallow breathing index. The total breathing frequency (fTotal) divided by the exhaled tidal volume (VTE). Can be configured to display RSB or P0.1.
P0.1 (cmH2O)	Airway occlusion pressure. The pressure drop during the first 100 ms when a breath is triggered. Can be configured to display RSB or P0.1.
%fSpont (%)	Spontaneous breath percentage. The moving average of the percentage of spontaneous breaths over the last 10 total breaths. Can be configured to display %fSpont or VariIndex.
VariIndex (%)	Variability index. The coefficient of variation of the Vt/TI index calculated from the last 100 breaths. Can be configured to display %fSpont or VariIndex.

³⁶ Weaning zone defaults are based on normal values < 100 / (l*min) for adult patients. Default values can be changed in Configuration.

8.4.2.1 Displaying the Vent Status panel

The Vent Status panel can be displayed in layouts 2 and 3 (Table 8-2).

To display the Vent Status panel

1. Touch the area of the display where you wish to show the Vent Status panel (Section 8.3.1).
A pop-up window opens showing the available display options.
2. Using the P&T knob, highlight and select **Vent Status**.

The Vent Status panel is displayed (Figure 8-17).

8.4.3 ASV Graph panel: real-time patient condition and targets

Available in ASV³⁷ mode, the ASV Graph shows how the adaptive lung controller moves toward its targets. The graph shows both the target and real-time patient data for tidal volume, frequency, and minute ventilation.

Figure 7-18 in Chapter 7 describes the graph in detail.

8.4.3.1 Displaying the ASV Graph

The ASV Graph can be displayed in layouts 2 and 3 (Table 8-2).

To display the ASV Graph

1. Touch the area of the display where you wish to show the ASV Graph (Section 8.3.1).
A pop-up window opens showing the available display options.
2. Using the P&T knob, highlight and select **ASV Graph**.

The ASV Graph is displayed (Figure 8-18).

Figure 8-18. ASV Graph panel (1)

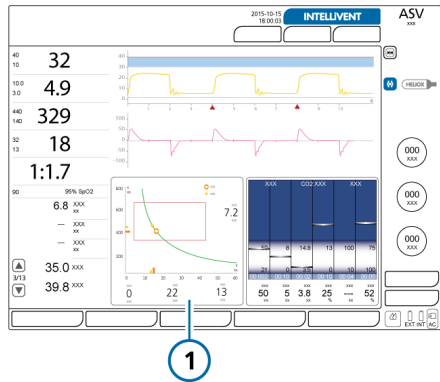

³⁷ Only for adult/pediatric patients.

8.4.4 ASV Monitoring panel: real-time values

The ASV Monitoring panel provides numeric target and current values for tidal volume, pressure, and minute volume.

To display the ASV Monitoring panel

1. Touch the area of the display where you wish to show the ASV Monitoring panel (Section 8.3.1).

A pop-up window opens showing the available display options.

2. Using the P&T knob, highlight and select **ASV Monitor**.

The ASV Monitoring panel is displayed (Figure 8-19).

Figure 8-19. ASV Monitoring panel (1)

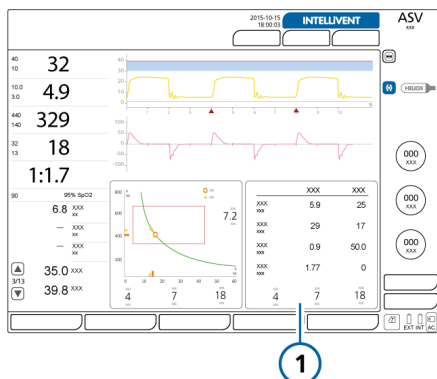

8.5 Monitoring transpulmonary/esophageal pressure

⚠ WARNING

- To monitor the pressure at the end of the tracheal tube as the Paux pressure, you must enable rinse flow. Rinse flow generates a weak flow toward the patient that keeps the lumen of the carina clear of mucus.
- When the rinse flow is enabled, an esophageal balloon *cannot* be used to provide the Pes (Paux) pressure, as this can cause the balloon to overinflate, potentially resulting in patient injury.
- Rinse flow can only be enabled/disabled by authorized service personnel. It is disabled by default.

The Paux port allows you to use pressure readings other than airway pressure (Paw), for example, from an esophageal balloon catheter, for monitoring purposes. While Paw measures the airway pressure at the proximal flow sensor, Paux is measured at the Pes (Paux) port on the ventilator. Using a combination of the Paw and Paux pressures, transpulmonary pressure is also calculated.

For connection details, see Section 3.5.

Once connected, the following parameter values are available (Figure 8-20): Ptrans I, and Ptrans E (see Table 8-5 for descriptions). In addition, pressure-based parameters are shown in orange, indicating that the values are based on Pes (Paux) input: AutoPEEP, Cstat, PEEP/CPAP, Pmean, Pminimum, Ppeak, Pplateau, PTP, P0.1, RCexp, Rinsp, RCinsp, and WOBimp.

Pes and Ptranspulm values can also be viewed as waveforms (Section 8.3.3), loops (Section 8.3.5), and Graphs in P/V Tool (Section 11.6).

Figure 8-20. Pes-related parameters in the Monitoring > 2 window

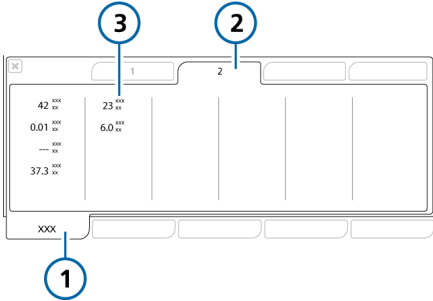

- 1 Monitoring
- 2 2 tab
- 3 Pes (Paux)-related parameter values

8.6 About the monitored parameters

The following table is an alphabetical list of the ventilator’s monitored parameters.

You can review all parameter values in the Monitoring window (Section 8.2.3). The display of monitored parameters is updated every breath or is time driven.

See Section 16.6 for parameter specifications.

For details about SpO2-related parameters, see the *Pulse Oximetry Instructions for Use*.

Table 8-5. Monitored parameters

Parameter (unit)	Definition
Pressure	
AutoPEEP (cmH ₂ O)	<p>The difference between the set PEEP and the calculated total PEEP within the lungs.</p> <p>AutoPEEP is the abnormal pressure generated by air “trapped” in the alveoli due to inadequate lung emptying. Ideally, it should be zero. AutoPEEP is calculated using the LSF method applied to the entire breath.</p> <p>Actively breathing patients can create artifacts or noise, which can affect the accuracy of these measurements.</p> <p>When AutoPEEP is present, volutrauma or barotrauma might develop. In active patients, AutoPEEP may present an extra workload to the patient.</p> <p>AutoPEEP or air trapping may result from an expiratory phase that is too short, which may be observed under the following conditions:</p> <ul style="list-style-type: none"> • Delivered tidal volume too large • Expiratory time too short or respiratory rate too high • Circuit impedance too high or expiratory airway obstruction • Peak expiratory flow too low
Driving pressure, ΔP^{38} (cmH ₂ O)	A calculated value showing the ratio of tidal volume to static compliance, which reflects the difference between P _{plateau} and total PEEP.
Paux (cmH ₂ O)	Auxiliary pressure. Measured at the Paux port, this allows to use pressure readings other than airway pressure, for example, from an esophageal balloon catheter.
PEEP/CPAP (cmH ₂ O)	<p>Monitored PEEP/CPAP. The airway pressure at the end of exhalation.</p> <p>Measured PEEP/CPAP may differ slightly from the set PEEP/CPAP, especially in spontaneously breathing patients.</p>

³⁸ Not available in all markets.

Parameter (unit)	Definition
P _{insp} (cmH ₂ O)	<p>Inspiratory pressure, the automatically calculated target pressure (additional to PEEP) applied during the inspiratory phase.</p> <p>Also displayed in the Vent Status panel.</p> <p>Not all modes use the P_{insp} parameter. Rather, this target pressure is set using the following parameters, depending on the selected mode:</p> <ul style="list-style-type: none"> • APV_{cmv}, APV_{simv}, ASV: Automatically calculated target pressure • P-CMV: P_{control} setting • P-SIMV, NIV-ST, nCPAP-PS: P_{insp} setting • SPONT, NIV: P_{support} setting • APRV, DuoPAP: P high setting
P _{mean} (cmH ₂ O)	<p>Mean airway pressure. The absolute pressure, averaged over the breath cycle.</p> <p>P_{mean} is an important indicator of the possible impact of applied positive pressure on hemodynamics and surrounding organs.</p>
P _{minimum} (cmH ₂ O)	<p>Minimum airway pressure of the previous breath cycle.</p> <p>P_{minimum} can be lower than PEEP/CPAP if TRC is active, or if the patient is making strong inspiratory efforts.</p>
P _{peak} (cmH ₂ O)	<p>Peak airway pressure. The highest pressure during the previous breath cycle.</p> <p>It is influenced by airway resistance and compliance. P_{peak} may differ noticeably from alveolar pressure if airway resistance is high. This value is always displayed.</p> <p>P_{peak} is also used by IntelliCuff to control cuff pressure in Auto mode. For details, see Section 12.2.3.</p>
P _{plateau} (cmH ₂ O)	<p>Plateau or end-inspiratory pressure. The pressure measured at the end of inspiration when flow is at or close to zero.</p> <p>Used as a rough representation of alveolar pressure. P_{plateau} is displayed for mandatory and time-cycled breaths.</p>
P _{trans} E ³⁹	<p>Calculated from the P_{transpulm} waveform. The arithmetic mean value of P_{transpulm} over the last 100 ms of the last expiration.</p>
P _{trans} I ³⁹	<p>Calculated from the P_{transpulm} waveform. The arithmetic mean value of P_{transpulm} over the last 100 ms of the last inspiration.</p>

³⁹ Data is available only when an esophageal catheter is connected to the Pes port on the ventilator.

Parameter (unit)	Definition
Flow	
Flow (l/min)	The set flow of gas to the patient in Hi Flow O2 mode.
Exp Flow (l/min)	Peak expiratory flow.
Insp Flow (l/min)	Peak inspiratory flow, spontaneous or mandatory. Measured every breath.
Volume	
ExpMinVol MinVol NIV (l/min)	Expiratory minute volume. The moving average of the monitored expiratory volume per minute over the last 8 breaths. ExpMinVol changes to MinVol NIV in noninvasive modes. MinVol NIV is an adjusted parameter taking into account the leakage.
MVSpont MVSpO NIV (l/min)	Spontaneous expiratory minute volume. The moving average of the monitored expiratory volume per minute for spontaneous breaths, over the last 8 mandatory and spontaneous breaths. In noninvasive ventilation modes, MVSpont is replaced by MVSpO NIV . MVSpO NIV is an adjusted parameter taking into account the leakage.
VLeak (%) MVLeak (l/min)	Due to the leakage at the patient interface, displayed exhaled volumes in the noninvasive modes can be substantially smaller than the delivered volumes. The flow sensor measures the delivered volume and the exhaled tidal volume; the ventilator displays the difference as VLeak in % or ml, and as MVLeak in l/min, averaged over the past 8 breaths. VLeak/MVLeak can indicate leaks on the patient side of the flow sensor. They do not include leakage between the ventilator and the flow sensor. Use VLeak and MVLeak to assess the fit of the mask or other noninvasive patient interface.
VTE VTE NIV (ml)	Expiratory tidal volume, the volume exhaled by the patient. It is determined from the flow sensor measurement, so it does not show any volume added due to compression or lost due to leaks in the breathing circuit. If there is a gas leak on the patient side, the displayed VTE may be less than the tidal volume the patient actually receives. In noninvasive ventilation modes, VTE is replaced by VTE NIV . VTE NIV is an adjusted parameter taking into account the leakage.

Parameter (unit)	Definition
VTESpont (ml)	Spontaneous expiratory tidal volume, the volume exhaled by the patient. If there is a gas leak on the patient side, the displayed VTESpont may be less than the tidal volume the patient actually receives. Only displayed for spontaneous breaths.
VTI (ml)	Inspiratory tidal volume, the volume delivered to the patient, determined from the flow sensor measurement. If there is a gas leak on the patient side, the displayed VTI may be larger than the displayed VTE.
Vt/IBW Vt/Wt (kg)	Tidal volume is calculated according to ideal body weight (IBW) for adult/pediatric patients and according to the actual body weight for neonatal patients.
Time	
fSpont (b/min)	Spontaneous breath frequency. The moving average of spontaneous breaths per minute over the last 8 total breaths.
fTotal (b/min)	Total breathing frequency. The moving average of the patient's total breathing frequency over the last 8 breaths, including both mandatory and spontaneous breaths. When the patient triggers a breath or the operator initiates a breath, fTotal may be higher than the Rate setting.
I:E	Inspiratory:expiratory ratio. Ratio of the patient's inspiratory time to expiratory time for every breath cycle. This includes both mandatory and spontaneous breaths. I:E may differ from the set I:E ratio if the patient breathes spontaneously.
TE (s)	Expiratory time. In mandatory breaths, TE is measured from the start of exhalation until the set time has elapsed for the switch to inspiration. In spontaneous breaths, TE is measured from the start of exhalation, as dictated by the ETS setting, until the patient triggers the next inspiration. TE may differ from the set expiratory time if the patient breathes spontaneously.
TI (s)	Inspiratory time. In mandatory breaths, TI is measured from the start of breath delivery until the set time has elapsed for the switch to exhalation. In spontaneous breaths, TI is measured from the patient trigger until the flow falls to the ETS setting for the switch to exhalation. TI may differ from the set inspiratory time if the patient breathes spontaneously.

Parameter (unit)	Definition
Other calculated and displayed parameters	
Cstat (ml/cmH ₂ O)	<p>Static compliance of the respiratory system, including lung and chest wall compliances, calculated using the LSF method. Cstat can help diagnose changes in elastic characteristics of the patient's lungs.</p> <p>Actively breathing patients can create artifact or noise, which can affect the accuracy of these measurements.</p>
IBW (kg)	Ideal body weight. A calculated value using height and sex, for adult and pediatric patients.
Oxygen (%)	<p>Oxygen concentration of the delivered gas. It is measured by an O₂ sensor in the inspiratory pneumatics.</p> <p>This parameter is not displayed if the O₂ sensor is not installed, is defective, is not a genuine Hamilton Medical part, or if oxygen monitoring is disabled.</p>
P0.1 (cmH ₂ O)	<p>Airway occlusion pressure. The pressure drop during the first 100 ms when a breath is triggered. P0.1 indicates the patient's respiratory drive and patient inspiration effort.</p> <p>P0.1 applies only to patient-triggered breaths.</p> <p>A P0.1 value of -3 cmH₂O indicates a strong inspiratory effort, and a value of -5 cmH₂O indicates an excessive effort, possibly because the patient is "air hungry" (peak inspiratory flow or total ventilatory support is inadequate) or has an excessive drive.</p> <p>If P0.1 is below -3 cmH₂O:</p> <ul style="list-style-type: none"> • Increase pressure or volume settings (depending on mode) • Increase %MinVol (ASV mode only) • Shorten P-ramp

Parameter (unit)	Definition										
PTP (cmH ₂ O*s)	<p>Inspiratory pressure time product.</p> <p>The measured pressure drop required to trigger the breath multiplied by the time interval until the PEEP/CPAP level is reached at the beginning of inspiration.</p> <p>PTP is valid for patient-initiated breaths only, and indicates work by the patient to trigger the breath. The work depends on:</p> <ul style="list-style-type: none"> • The intensity of the patient’s effort • The trigger sensitivity • The volume and resistance of the breathing circuit <p>PTP does not indicate total patient work but is a good indicator of how well the ventilator is adjusted for the patient.</p> <p>If PTP values increase, do the following:</p> <ul style="list-style-type: none"> • Increase trigger sensitivity • Decrease P-ramp 										
RCexp (s)	<p>Expiratory time constant. The rate at which the lungs empty, as follows:</p> <table border="1"> <thead> <tr> <th>Actual TE</th> <th>% emptying</th> </tr> </thead> <tbody> <tr> <td>1 x RCexp</td> <td>63%</td> </tr> <tr> <td>2 x RCexp</td> <td>86.5%</td> </tr> <tr> <td>3 x RCexp</td> <td>95%</td> </tr> <tr> <td>4 x RCexp</td> <td>98%</td> </tr> </tbody> </table> <p>RCexp is calculated as the ratio between VTE and flow at 75% of the VTE.</p> <p>Normal values in intubated adult patients:</p> <ul style="list-style-type: none"> • Short, < 0.6 seconds: restrictive disease (ARDS, atelectasis, chest wall stiffness) • Normal, 0.6 to 0.9 seconds: normal compliance and resistance, or combined decreased compliance and increased resistance • Long, > 0.9 seconds: obstructive disease (COPD, asthma), bronchospasm, ET tube obstruction, or incorrect positioning <p>Use RCexp to set the optimum TE (Goal: TE ≥ 3 x RCexp):</p> <ul style="list-style-type: none"> • With passive patients: Adjust Rate and I:E • With active patients: Increase Psupport and/or ETS to achieve a longer TE <p>These actions may reduce the incidence of AutoPEEP.</p>	Actual TE	% emptying	1 x RCexp	63%	2 x RCexp	86.5%	3 x RCexp	95%	4 x RCexp	98%
Actual TE	% emptying										
1 x RCexp	63%										
2 x RCexp	86.5%										
3 x RCexp	95%										
4 x RCexp	98%										

Parameter (unit)	Definition
RCinsp (s)	<p>Inspiratory time constant. RCinsp represents the rate at which the lungs inflate. It is calculated from Rinsp and Cstat using the LSF method.</p> <p>An inspiratory time constant shorter than 2 x RCinsp indicates disequilibrium between ventilator and alveolar pressure and can indicate inadequate inspiration.</p>
Rexp (cmH ₂ O / (l/s))	<p>Resistance to expiratory flow caused by the endotracheal tube and the patient's airways during expiration.</p> <p>It is calculated using the LSF method applied to the expiratory phase.</p>
Rinsp (cmH ₂ O / (l/s))	<p>Resistance to inspiratory flow caused by the endotracheal tube and the patient's airways during inspiration.</p> <p>It is calculated using the LSF method applied to the inspiratory phase. Also displayed in the Dynamic Lung panel.</p> <p>Actively breathing patients can create artifact or noise, which can affect the accuracy of these measurements.</p>
RSB (1 / (l*min))	<p>Rapid shallow breathing index.</p> <p>The total breathing frequency (fTotal) divided by the exhaled tidal volume (VTE).</p> <p>Because a patient with dyspnea typically takes faster and shallower breaths than a non-dyspnoeic patient, RSB is high in the dyspnoeic patient and low in the non-dyspnoeic patient.</p> <p>RSB is often used clinically as an indicator of a ventilated patient's readiness for weaning.</p> <p>RSB is only significant for spontaneously breathing patients weighing > 40 kg and is only shown if 80% of the last 25 breaths were spontaneous.</p>
VarilIndex (%)	<p>Variability index. The coefficient of variation of the Vt/TI index calculated from the last 100 breaths.</p>
WOBimp (J/l)	<p>Work of breathing imposed by the inspiratory valve, tubing, and humidifier. It is airway pressure integrated over inspiratory volume until pressure exceeds the PEEP/CPAP level. In the dynamic pressure/volume loop, WOBimp is the area below PEEP/CPAP. This is created exclusively by the patient; thus WOBimp is valid for patient-initiated breaths only.</p> <p>If based on Paw, WOBimp indicates the work required of the patient to be on a ventilator. It does not include work resulting from the endotracheal tube and the total respiratory system. If based on endotracheal pressure using Pes (Paux), WOBimp includes work resulting from the endotracheal tube.</p> <p>The significance of WOBimp is similar to that of PTP. For more information, see the description of PTP in this table.</p>

Parameter (unit)	Definition
CO2 related	
FetCO2 (%)	<p>Fractional end-tidal CO2 concentration.</p> <p>Permits assessment of PaCO2 (arterial CO2). Note that it is inaccurate in pulmonary embolism.</p> <p>Available when a CO2 sensor is connected and enabled.</p>
PetCO2 (mmHg)	<p>End-tidal CO2 pressure.</p> <p>The maximum partial pressure of CO2 exhaled during a tidal breath (just before the start of inspiration). It represents the final portion of air that was involved in the exchange of gases in the alveolar area, thus providing a reliable index of CO2 partial pressure in the arterial blood under certain circumstances.</p> <p>PetCO2 does not reflect PaCO2 in the case of a pulmonary embolism.</p> <p>Available when a CO2 sensor is connected and enabled.</p>
slopeCO2 (%CO2/l)	<p>Slope of the alveolar plateau in the PetCO2 curve, indicating the volume/flow status of the lungs.</p> <p>Permits assessment of chronic hypercapnia, asthma, and inefficient ventilation.</p> <p>Available when a CO2 mainstream sensor is connected and enabled.</p>
V'alv (ml/min)	<p>Alveolar minute ventilation.</p> <p>Permits assessment of actual alveolar ventilation (as opposed to minute ventilation).</p> <p>$V_{alv} * f$ (normalized to 1 min)</p> <p>Available when a CO2 mainstream sensor is connected and enabled.</p>
V'CO2 (ml/min)	<p>CO2 elimination.</p> <p>Net exhaled volume of CO2 per minute. Permits assessment of metabolic rate (for example, it is high with sepsis) and treatment progress.</p> <p>Available when a CO2 mainstream sensor is connected and enabled.</p>
VDaw (ml)	<p>Airway dead space.</p> <p>Gives an effective, in-vivo measure of volume lost in the conducting airways. A relative increase in dead space points to a rise in respiratory insufficiency and can be regarded as an indicator of the current patient situation. Patients with high dead space values are at particular risk if the muscles also show signs of fatigue.</p> <p>Available when a CO2 mainstream sensor is connected and enabled.</p>
VDaw/VTE (%)	<p>Airway dead space fraction at the airway opening.</p> <p>Available when a CO2 mainstream sensor is connected and enabled.</p>

Parameter (unit)	Definition
VeCO2 (ml)	Exhaled CO2 volume, updated breath by breath. Available when a CO2 mainstream sensor is connected and enabled.
ViCO2 (ml)	Inspired CO2 volume, updated breath by breath. Available when a CO2 mainstream sensor is connected and enabled.
Vtalv (ml)	Alveolar tidal ventilation. VTE - VDaw Available when a CO2 mainstream sensor is connected and enabled.
Humidifier related	
T humidifier (°C)	<i>For HAMILTON-H900 humidifier only. See Table 12-5.</i>
IntelliCuff related	
Pcuff (cmH2O)	<i>For IntelliCuff only. See Section 12.2.7.</i>

8.7 Viewing patient ventilation time

The Patient window displays a timer that shows how long the patient has been ventilated.

Figure 8-21. Ventilation timer

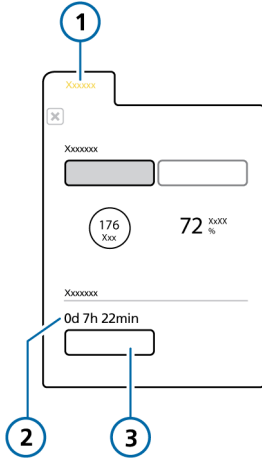

- 1 Patient 3 Reset
2 Ventilation time (days, hours, minutes)

The timer records time as follows:

- The timer starts when you start ventilation.
- When you enter Standby, the timer pauses. It picks up again from the last value when you exit Standby and return to active ventilation.
- When you set up a new patient in the Standby window, and start ventilation, the timer resets to 0.
- When you select **Last Patient** in the Standby window, the timer continues from the last total time recorded.
- When you touch the **Reset** button, the timer resets to 0.

When the timer is reset, an entry is made to the Event log recording the time of the reset, as well as how long the ventilator had been running prior to the reset.

To reset the timer to 0

1. Open the Patient window.
2. Touch the **Reset** button.

The timer starts again at 0d 0h 00min.

8.8 Viewing device-specific information

Open the System > Info window to view device-specific information including serial number, model, operating hours, software version, and installed options.

9

Responding to alarms

9.1	Overview.....	184
9.2	About the alarm buffer	187
9.3	Adjusting alarm loudness (volume)	189
9.4	Troubleshooting alarms	189
9.5	Working with a distributed alarm system (DAS)	205

9.1 Overview

Operator-adjustable and nonadjustable alarms together with a visual alarm indicator help ensure your patient's safety. These alarms notify you of conditions that require your attention.

These alarms can be categorized as high, medium, or low priority, as described in Table 9-1. Figure 9-1 shows the ventilator's visual alarm indications.

Additional alarms conditions are associated with technical fault and technical note alarms, as well as informational messages.

You can view active alarms in the alarm buffer (Figure 9-2). Information about the alarm is also stored in the Event log.

Alarms are indicated in the color associated with the alarm priority as follows:

- The alarm lamp on top of the monitor lights and flashes.
- The alarm text is shown in color in the message bar on the ventilator display.
- An MMP associated with an active alarm, as well as the affected alarm limit, is shown in the associated color.
- In the Monitoring window, a parameter associated with an active alarm is shown in the associated color.
- Any affected parameter shown in the Dynamic Lung is shown in color.
- The alarm text is displayed in the alarm buffer.

When an alarm condition is serious enough to possibly compromise safe ventilation, the device defaults to the Ambient state (Section 7.8). The inspiratory valve closes, and the ambient and expiratory valves are opened, letting the patient breathe room air unassisted.

If communication between the ventilator monitor (referred to as the *interaction panel* in alarm messages) and the ventilator unit is disrupted, the status indicators on the front of the ventilator body provide a visual indication of the ventilator status. For details about the indicators, see Table 2-3.

For details on setting alarm limits, see Section 5.6.

Table 9-1 describes the audio and visual characteristics of these types of alarms and provides guidance on how to respond.

Table 9-1. Alarm indicators

Alarm type	Message bar	Alarm lamp / Alarm status indicator	Audio	Action required
High priority	Red, with alarm message	Red, flashing ⁴⁰ Alarm status indicator on the front of the ventilator body is lit	A sequence of 5 beeps, repeated until the alarm is reset.	The patient's safety is compromised. The problem needs immediate attention.
Medium priority	Yellow, with alarm message	Yellow, flashing ⁴⁰ Alarm status indicator on the front of the ventilator body is lit	A sequence of 3 beeps, repeated periodically.	The patient needs prompt attention.
Low priority	Yellow, with alarm message	Yellow, solid ⁴⁰ Alarm status indicator on the front of the ventilator body is lit	Two sequences of beeps. This is not repeated.	Operator awareness is required.
Technical fault	Red, with the text <i>Technical fault: xxxxxx</i>	Red, flashing Alarm status indicator on the front of the ventilator body is lit	Same as for high-priority alarm, if technically possible. At a minimum, a continuous buzzer tone. The buzzer cannot be silenced.	<ul style="list-style-type: none"> • Provide alternative ventilation. • Turn off the ventilator. • Have the ventilator serviced.

⁴⁰ When heliox is selected, the alarm lamp is always lit blue. If an alarm is generated, the alarm lamp alternates between blue and red/yellow, depending on the alarm priority.

Figure 9-1. Visual alarm indicators

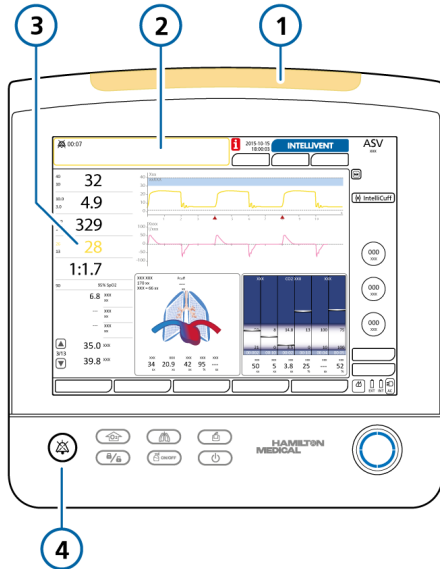

- | | |
|---------------|-----------------------------|
| 1 Alarm lamp | 3 MMP associated with alarm |
| 2 Message bar | 4 Audio Pause key |

9.1.1 Alarm limit indicators

Alarm limits are shown:

- In the Alarms > Limits windows
- On the main display to the left of the MMPs, when appropriate

When an alarm limit is disabled, that is, no limit applies, the device shows the following Alarm Off⁴¹ symbol:



⁴¹ Not available in all markets.

9.1.2 Responding to an alarm

⚠ WARNING

When an audio pause is active, the following critical alarms still generate an audible alarm:

- Apnea
- Apnea backup
- Air supply failed
- Oxygen supply failed
- Heliox supply failed
- Air and heliox supplies failed
- Oxygen and air supplies failed
- Oxygen and heliox supplies failed
- All gas supplies failed
- Low oxygen
- Check internal battery
- Internal battery low
- Internal battery empty
- Loss of mains power
- Low internal pressure
- SpO2 too low
- Panel connection lost
- Ventilator unit connection lost
- Remote communication error
- Remote communication timeout

⚠ CAUTION

Carefully set alarm limits according to the patient's condition. Setting limits too high or too low defeats the purpose of the alarm system.

Alarms may result from either a clinical condition or an equipment issue. In addition, a single alarm condition can generate multiple alarms.

Your search for the causes of the alarm condition should be assisted by, but not limited to, the alarm messages displayed.

To respond to an alarm

1. Approach the patient immediately.
2. Secure sufficient and effective ventilation for the patient.

You can pause the audible alarm, if appropriate and available.

3. Correct the alarm condition from the alarm messages.

For a technical fault, remove the ventilator from use, note the fault code, and have the ventilator serviced.

4. If appropriate, readjust the alarm limit.

9.1.3 Temporarily silencing an alarm

One component of an alarm is the audible alarm sound. With most alarms, you can pause (silence) the alarm sound for two minutes at a time.

When the ventilator is used with a distributed alarm system, you can activate **global AUDIO OFF**, silencing most ventilator alarms for an unlimited period of time. For details about working with a distributed alarm system, see Section 9.5.

To temporarily silence an alarm

- ▶ Press the **Audio Pause** key on the front of the ventilator monitor (Figure 10-2).

The audible ventilator alarm is muted for two minutes. Pressing the key a second time cancels the audio pause.

The **Audio Pause** key backlight is continuously lit in red while an audio pause is active.

The display also indicates an audio pause is engaged as follows (Figure 9-1):

- The **Audio Pause** indicator is displayed.
- A countdown timer on the main display shows the remaining time for the audio pause.

When the time expires and the issue has not yet been resolved, the alarm sounds again.

9.2 About the alarm buffer

The alarm buffer shows up to six alarm messages:

- The alarm buffer shows active alarms as they are generated (Figure 9-2). The alarm messages also alternate in the message bar.
- If no alarms are active, the **Events > Alarms** window shows inactive alarms (Figure 9-3). In addition, the **i**-icon is visible on the display.

To view active alarms

1. Open the Alarms > Buffer window.
2. Touch an active alarm in the message bar at the top of the display (Figure 9-2).

The most recent alarm is at the top of the list.

To view inactive alarms

- ▶ Do either of the following:
 - Open the Events > Alarms window.
 - Touch the inactive alarm indicator (the i-icon) (Figure 9-3).

The most recent alarm is at the top of the list.

Figure 9-2. Alarm buffer with active alarms

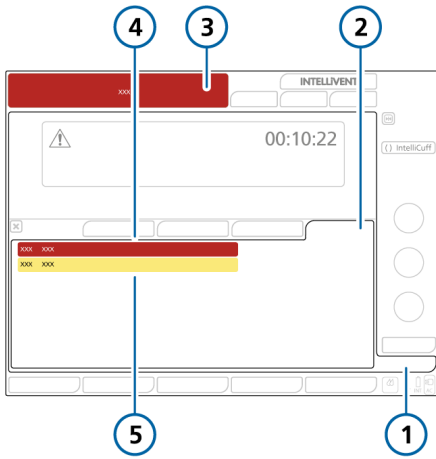

- 1 Alarms
- 2 Buffer
- 3 Alarm text in message bar
- 4 High-priority alarm (red)
- 5 Low- or medium-priority alarm (yellow)

Figure 9-3. Events > Alarms window with inactive alarms

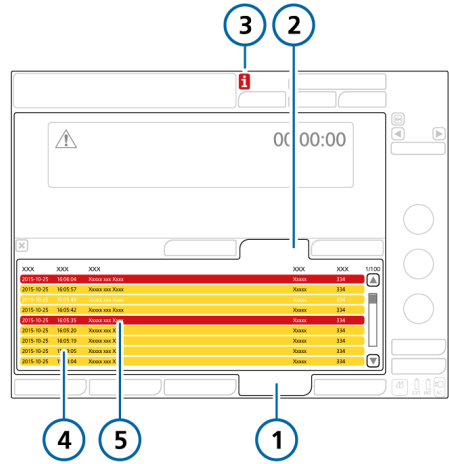

- 1 Events
- 2 Alarms
- 3 i-icon
- 4 Inactive low- or medium-priority alarm (yellow)
- 5 Inactive high-priority alarm (red)

9.3 Adjusting alarm loudness (volume)

WARNING

Be sure to set the auditory alarm loudness above the ambient sound level. Failure to do so can prevent you from hearing and recognizing alarm conditions.

You can set the loudness of the audible alarm.

By default, the loudness is set to 5. If you set the loudness below the default, the next time the ventilator is turned on the loudness is reset to the default value.

You cannot set the loudness below the minimum level configured for the device (Chapter 14).

To adjust the alarm loudness

1. Open the Alarms > Loudness window.
2. Activate and adjust the **Loudness** control, as needed.
3. Touch **Test** to check the loudness level.
Ensure the loudness level is above the ambient sound level.
4. Repeat the process as required, and close the window.

Figure 9-4. Alarm loudness control

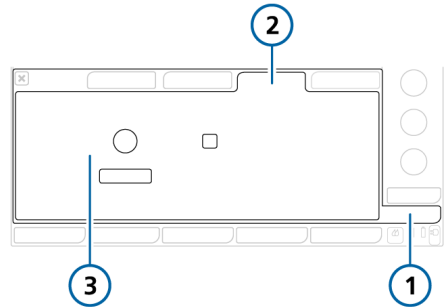

- | | |
|------------|------------------------------------|
| 1 Alarms | 3 Loudness control and Test button |
| 2 Loudness | |

9.4 Troubleshooting alarms

Table 9-2 is an alphabetical list of the alarm messages displayed by the HAMILTON-S1, along with their definitions and suggested corrective actions.

These corrective actions are sequenced to correct the most probable issue or to present the most efficient corrective action first. The proposed actions, however, may not always correct the particular problem.

If your issue is not resolved after performing the recommended tasks, contact your Hamilton Medical authorized service personnel.

For additional alarm information, see the appropriate documentation as follows:

- For SpO₂-related alarms, see the *Pulse Oximetry Instructions for Use*.
- For INTELLiVENT-ASV-related alarms, see the *INTELLiVENT-ASV Operator's Manual*.
- For HAMILTON-H900-related alarms, see Section 12.1.6 and the *HAMILTON-H900 Instructions for use*.
- For IntelliCuff-related alarms, see Section 12.2.6 and the *IntelliCuff Instructions for use*.

Table 9-2. Alarms and other messages

Alarm	Definition	Action needed
Aerogen disconnected	<i>Medium priority.</i> Aerogen is active and the nebulizer cable is disconnected.	Connect the nebulizer cable.
Aerogen module disconnected	<i>Low priority.</i> Aerogen is active and the module is removed or cannot be identified.	Inspect the connection of the module.
Air supply failed	<i>Medium priority.</i> The air supply pressure < 1.9 bar (190 kPa/28 psi) or the input flow dropped below 40 l/min. The device will ventilate the patient with 100% oxygen if the internal pressure can be maintained. (The alarm is not activated when the Oxygen setting is 100%.)	<ul style="list-style-type: none"> • Inspect air supply. • Increase air supply pressure. • Consider changing source.
Air+heliox supplies failed	<i>Medium priority.</i> Both alarms appear at the same time	<ul style="list-style-type: none"> • Inspect all gas supplies. • Consider changing one or more of the gas sources.
All gas supplies failed	<i>High priority.</i> All three alarms appear at the same time	<ul style="list-style-type: none"> • Inspect all gas supplies. • Consider changing one or more of the gas sources.
Apnea ventilation ended	<i>Low priority.</i> Backup mode was reset, and ventilator is again ventilating in its original support (pre-apnea) mode.	No action required.

Alarm	Definition	Action needed
Apnea ventilation	<i>Low priority.</i> Apnea backup ventilation has started. No breath delivered for the operator-set apnea time. Apnea backup ventilation is on.	<ul style="list-style-type: none"> • Check patient condition. • Check trigger sensitivity. • Check the control settings for the backup mode. • Consider changing the mode.
Apnea	<i>High priority.</i> No patient trigger within the operator-set apnea time in APVsimv, VS, SIMV, P-SIMV, SPONT, DuoPAP, APRV, or NIV mode. Apnea backup is off.	<ul style="list-style-type: none"> • Check patient condition. • Check trigger sensitivity. • Consider changing the mode.
APV: Check high pressure limit	<i>Low priority.</i> The calculated APV pressure to reach V_{target} is higher than the operator-set high Pressure alarm limit.	<ul style="list-style-type: none"> • Check patient condition. • Consider increasing the inspiratory time.
APV: Check high pressure limit	<i>Low priority.</i> The operator-set high Pressure alarm limit is too low, the ventilator cannot deliver V_{target} .	<ul style="list-style-type: none"> • Check patient condition. • Consider increasing the high Pressure alarm limit. • Consider decreasing V_{target}.
ASV/APV: Initialization failed	<i>Medium priority.</i> ASV, APVsimv, or APVcmv cannot start, because the test breath results are not acceptable.	<ul style="list-style-type: none"> • Consider increasing the high Pressure alarm limit. The difference between PEEP/CPAP and the high Pressure limit must be > 25 cmH₂O. • Calibrate the flow sensor. • Check the system for leaks. • Replace the flow sensor. • Consider changing the mode.
ASV: Cannot meet the target	<i>Low priority.</i> The operator-set %MinVol cannot be delivered, possibly due to setting conflicts or lung-protective rules.	<ul style="list-style-type: none"> • Check patient condition. • Check the P ASV limit settings and adjust if appropriate. • Consider a mode change. However, be aware that other modes may not enforce lung-protective rules.

Alarm	Definition	Action needed
ASV: Check high pressure limit	<i>Low priority.</i> The operator-set high pressure alarm limit is too low, and the ventilator cannot deliver the calculated target tidal volume.	<ul style="list-style-type: none"> • Check patient condition. • Consider performing a suctioning maneuver. • Check and confirm settings, including alarms.
Cannot reach target flow	<i>Low priority.</i> The ventilator cannot apply the set flow to the patient; the measured flow is 10% or more below the set flow rate.	Check inlet pressure or reduce flow.
Check %MinVol	<i>Low priority.</i> The desired setting cannot be obtained because of setting conflicts	<ul style="list-style-type: none"> • Confirm the new setting. • Adjust other settings, as required.
Check %TI	<i>Low priority.</i> The chosen setting cannot be obtained because of setting conflicts.	<ul style="list-style-type: none"> • Confirm the new setting. • Adjust other settings, as required.
Check CO2 airway adapter	<i>Low priority.</i> Adapter disconnection, optical block or adapter type changed.	<ul style="list-style-type: none"> • Check patient condition. • Check the airway adapter for excess moisture accumulation /contamination by secretions. • Replace / perform zero calibration on airway adapter.
Check CO2 sampling line	<i>Low priority.</i> CO2 sidestream sensor sampling line occluded by water.	<ul style="list-style-type: none"> • Check patient condition. • Replace sampling line.
Check flow sensor for water	<p><i>Neonatal only.</i> Water is detected inside the flow sensor, which is affecting measurements.</p> <p><i>Medium priority.</i> You must acknowledge the alarm within 60 seconds by pressing the Audio Pause key. This gives you time to remove any accumulated water from the flow sensor and tubing. If the alarm is not acknowledged within 60 seconds, the alarm becomes <i>high priority</i>.</p> <p>The alarm is active until flow sensor measurements are again within the expected range.</p>	<ul style="list-style-type: none"> • Remove all water from the flow sensor and flow sensor tubing. • You <i>must</i> position the flow sensor at a > 45° angle to avoid water accumulation.

Alarm	Definition	Action needed
Check flow sensor tubing	<p><i>High priority.</i> The flow sensor tubes are disconnected or occluded.</p> <p>The ventilator switches to P-CMV mode and displays the internal ventilator pressure (Pvent) instead of airway pressure (Paw).</p> <p>The ventilator returns to the previous mode when measurements are within the expected range.</p>	<ul style="list-style-type: none"> • Check the flow sensor connection to the ventilator. • Connect and calibrate a new flow sensor.
Check flow sensor type	<p><i>High priority.</i> The flow sensor in use may not match the selected patient type. This is detected during ventilation.</p>	<ul style="list-style-type: none"> • Make sure the flow sensor is the correct type for the patient (Adult, Pediatric, or Neonatal) • Calibrate the flow sensor.
Check FlowPattern	<p><i>Low priority.</i> The desired setting cannot be obtained because of setting conflicts.</p>	<ul style="list-style-type: none"> • Confirm the new setting. • Adjust other settings, as required.
Check I:E	<p><i>Low priority.</i> The desired setting cannot be obtained because of setting conflicts.</p>	<ul style="list-style-type: none"> • Confirm the new setting. • Adjust other settings, as required.
Check internal battery	<p><i>High priority.</i> The internal battery or cable is disconnected or faulty.</p>	<ul style="list-style-type: none"> • Silence the alarm using the Audio Pause key. • Have the ventilator serviced.
Check patient interface	<p><i>High priority.</i> Internal pressure too high in Hi Flow O2. Flow cannot be delivered to the patient.</p>	<ul style="list-style-type: none"> • Observe the patient • Increase the pressure limit setting as required. • Check respiratory tubes for kinks.
Check pause	<p><i>Low priority.</i> The Pause setting is too long in relation to other breath timing parameters.</p>	<ul style="list-style-type: none"> • Confirm the new setting. • Adjust other settings, as required.
Check peak flow	<p><i>Low priority.</i> The desired setting cannot be obtained because of setting conflicts.</p>	<ul style="list-style-type: none"> • Confirm the new setting. • Adjust other settings, as required.
Check P-ramp	<p><i>Low priority.</i> The chosen setting cannot be obtained because of setting conflicts.</p>	<ul style="list-style-type: none"> • Confirm the new setting. • Adjust other settings, as required.

Alarm	Definition	Action needed
Check pressure alarm	<i>Low priority.</i> Pressure control cannot be changed due to the set alarm limit.	Change set alarm limit.
Check pressure controls	<i>Low priority.</i> Pressure alarm cannot be changed due to the high-pressure control setting.	Change set high-pressure control setting.
Check rate	<i>Low priority.</i> The chosen setting cannot be obtained because of setting conflicts.	<ul style="list-style-type: none"> • Confirm the new setting. • Adjust other settings, as required.
Check TI	<i>Low priority.</i> The chosen setting cannot be obtained because of setting conflicts.	<ul style="list-style-type: none"> • Confirm the new setting. • Adjust other settings, as required.
Check trigger	<i>Low priority.</i> The trigger is OFF and the operator has attempted to activate a mode allowing spontaneous breathing. The ventilator switches to the selected mode and uses a pressure trigger of -3 cmH ₂ O. It continues to alarm.	Verify the P-trigger setting or turn the Flowtrigger on.
Check volume limit	<i>Low priority.</i> The set volume limit is outside of the acceptable range.	<p>No action required.</p> <ul style="list-style-type: none"> • If V limit is set below the minimum, the ventilator automatically adjusts V limit to the minimum allowable setting. • If V limit is set above the maximum, the ventilator automatically adjusts V limit to the maximum allowable setting.
Check Vt	<i>Low priority.</i> The chosen setting cannot be obtained because of setting conflicts.	<ul style="list-style-type: none"> • Confirm the new setting. • Adjust other settings, as required.
CO ₂ sensor disconnected	<i>Low priority.</i> The CO ₂ module is installed, but there is no signal from the CO ₂ sensor. CO ₂ monitoring is enabled.	<ul style="list-style-type: none"> • Make sure a CO₂ sensor is connected. • Check CO₂ sensor connections (CO₂ sensor cable to module, CO₂ module to ventilator). • If the problem persists, have the ventilator serviced.

Alarm	Definition	Action needed
CO2 sensor faulty	<i>Low priority.</i> CO2 sensor signal indicates a hardware error or a third-party sensor is installed.	<ul style="list-style-type: none"> • Disconnect the sensor from the CO2 module. Wait a few seconds, and reconnect. • Perform a zero calibration of the sensor. Ensure the sensor is attached to the airway adapter during zero calibration. • Replace the CO2 sensor. Make sure the sensor is a genuine Hamilton Medical part.
CO2 sensor over temperature	<i>Low priority.</i> Temperature at CO2 sensor too high.	<ul style="list-style-type: none"> • Check whether the sensor is affected by an external heating source. • Remove the sensor from the airway, and disconnect the sensor from the CO2 module. Reconnect. • Verify that system is running within the specified environmental conditions. Check for excessive airway temperature, which could be caused by defective humidifier, heater wire, or probe.
CO2 sensor warming up	<i>Low priority.</i> CO2 operating temperature not yet reached or unstable.	Wait for sensor to warm up.
Disconnection on patient side	<i>High priority.</i> VTE is less than one-eighth of the delivered VTi, and delivered VTi exceeds 50 ml. Applicable in invasive modes. For APRV/DuoPAP, only during pressure phase.	<ul style="list-style-type: none"> • Check patient condition. • Check the breathing circuit for a disconnection between the patient and the flow sensor, or for other large leaks (for example, ET tube).

Alarm	Definition	Action needed
Disconnection on ventilator side	<i>High priority.</i> Measured VTI at the flow sensor is less than one-half of the delivered VTI, and delivered VTI exceeds 50 ml.	<ul style="list-style-type: none"> • Check the expiratory valve: <ul style="list-style-type: none"> – Check the condition of the expiratory valve set. If anything is defective, replace. – Check whether the expiratory valve is affected by any nebulizing agent. – Make sure that the expiratory valve is properly installed. – Check whether there is a disconnection at the expiratory valve. • Replace the expiratory valve. • Check the flow sensor. If needed, replace the flow sensor.
Disconnection	<i>High priority.</i> A disconnection was detected, but tidal volume is too low (< 200 ml) to determine whether it is on the patient or ventilator side.	Troubleshoot according to the Disconnection on patient side or Disconnection on ventilator side alarms.
Exhalation obstructed	<p><i>High priority.</i> Either the end-expiratory pressure is too high or the end-expiratory flow is too low.</p> <p>Note that you must use an inspiratory filter to prevent contamination. The ventilator may be contaminated if no inspiratory filter is used.</p> <p>Not active in Hi Flow O2 mode.</p>	<ul style="list-style-type: none"> • Check patient condition. • Check the expiratory limb for occlusion. • Check the expiratory valve set. Replace if needed. • Check the flow sensor tubes for occlusion. • Adjust breath timing controls to increase the expiratory time. • Provide alternative ventilation until the issue is resolved. • Have the ventilator serviced.
Expiratory valve calibration needed	<i>Low priority.</i> The ventilator does not have correct expiratory valve calibration data	Have the ventilator serviced.

Alarm	Definition	Action needed
External battery empty	<i>Low priority.</i> The extended battery pack is depleted. The device is running on its internal battery.	<ul style="list-style-type: none"> • Replace battery pack with a charged battery pack. • Wait for the extended battery pack to charge. • If extended battery pack is not fully charged after 7 hours, install a new extended battery pack.
Flow sensor calibration needed	<i>Low priority.</i> The ventilator does not have correct calibration data or automatic recalibration of the flow sensor is impossible.	<ul style="list-style-type: none"> • Calibrate the flow sensor as soon as possible. • Flow, volume, and pressure readings are less accurate with an uncalibrated flow sensor.
Heliox supply failed	<i>Medium priority.</i> The air supply Pressure < 1.9bar (190kPa/28psi) or the input Flow < 40 l/min.	<ul style="list-style-type: none"> • Inspect Heliox supply. • Increase Heliox supply Pressure. • Consider changing the Heliox source.
High frequency	<i>Medium priority.</i> The measured fTotal exceeds the set alarm limit.	<ul style="list-style-type: none"> • Check the patient for adequate ventilation (VTE). • Check alarm limits. • Check the trigger sensitivity. • If the ventilator is in ASV mode, see Section 7.10.
High leak	<i>Medium priority.</i> The percentage of delivered inspiratory volume that is not returned during exhalation exceeds the set Leak alarm limit.	Check for leaks at the patient interface, on the patient side of the flow sensor.
High minute volume	<i>High priority.</i> The measured Exp-MinVol exceeds the set alarm limit.	<ul style="list-style-type: none"> • Check patient condition. • Check and confirm settings, including alarms.
High oxygen	<i>High priority.</i> The measured oxygen is more than 5% (absolute) above the current Oxygen control setting.	<ul style="list-style-type: none"> • Calibrate the O2 sensor. • Install a new O2 sensor. • If using a paramagnetic O2 sensor, calibrate the sensor or have the ventilator serviced.

Alarm	Definition	Action needed
High PEEP	<p><i>Medium priority.</i> Monitored PEEP exceeds (set PEEP + 5 cmH₂O) for two consecutive breaths.</p> <p><i>For DuoPAP and APRV only:</i> Alarm applies to both P high and P low settings. The alarm sounds when the monitored P high exceeds (set P high + 5 cmH₂O) or monitored P low exceeds (set P low + 5 cmH₂O) for two consecutive breaths.</p>	<ul style="list-style-type: none"> • Check patient condition. • Check and confirm settings, including alarms. • Check the expiratory valve set for possible obstructions. • Check for obstructions in the expiratory limb.
High PetCO ₂	<p><i>Medium priority.</i> PetCO₂ exceeds the set alarm limit.</p>	<ul style="list-style-type: none"> • Check patient condition. • Check and confirm settings, including alarms.
High pressure during sigh	<p><i>High priority.</i> A sigh cannot be fully delivered because excessive inspiratory pressure would be required. The sigh is partially delivered.</p>	<ul style="list-style-type: none"> • Check patient condition. • Check the artificial airway of the patient for kinks and occlusions. • Check the breathing circuit and flow sensor tubes for kinks and occlusions. • Consider disabling the Sigh function.
High pressure	<p><i>High priority.</i> The measured inspiratory pressure exceeds the set high Pressure alarm limit. The ventilator immediately closes the inspiratory valve to stop gas flow to the patient and opens the expiratory valve to reduce pressure to the PEEP/CPAP level.</p> <p>If the pressure reaches 15 cmH₂O above the high Pressure alarm limit for longer than 5 seconds, the ventilator opens the release valve.</p> <p>If the pressure reaches 15 cmH₂O above the high Pressure alarm limit for longer than 7 seconds, the ventilator enters the Ambient state.</p>	<ul style="list-style-type: none"> • Check patient condition. • Adjust the Pressure alarm limit. • Check the artificial airway of the patient for kinks and occlusions. • Check the breathing circuit and flow sensor tubes for kinks and occlusions. • Provide alternative ventilation once the ventilator enters the Ambient state.

Alarm	Definition	Action needed
High tidal volume	<i>Medium priority.</i> Measured VTE exceeds the set limit for 2 consecutive breaths.	<ul style="list-style-type: none"> • Check the pressure and volume settings for potential leaks and/or disconnections. • Check and confirm settings, including alarms.
Internal battery empty	<i>High priority.</i> The ventilator is running on battery power and the battery charge level can support less than 10 minutes of ventilator operation.	<ul style="list-style-type: none"> • Connect the ventilator to primary power (AC). Connecting to primary power also charges the battery. • Immediately provide alternative ventilation until the issue is resolved. • If the problem still persists, have the ventilator serviced.
Internal battery low	<i>Medium priority.</i> The ventilator is running on battery power and the battery charge level can support less than 30 minutes of ventilator operation.	<ul style="list-style-type: none"> • Connect the ventilator to a primary power source. • Install charged battery. • If necessary, be prepared to provide alternative ventilation.
IRV	<i>Low priority.</i> The set I:E ratio is above 1:1, leading to inverse ratio ventilation. Does not apply in APRV.	Check the timing control settings.
Loss of mains power	<i>Low priority.</i> The ventilator is running on battery power due to loss of a primary power source.	<ul style="list-style-type: none"> • Silence the alarm. • Check integrity of connection to primary power source. • Check battery status. • Prepare for possible power loss. • Provide alternative ventilation until the issue is resolved.
Loss of PEEP	<i>Medium priority.</i> One of the following conditions is in effect: <ul style="list-style-type: none"> • Pressure during exhalation is below (set PEEP/CPAP – 3 cmH₂O) for more than three consecutive breaths. • Measured end-expiratory pressure is below (set PEEP/CPAP – 3 cmH₂O) for two consecutive breaths. 	<ul style="list-style-type: none"> • Check patient condition. • Check the breathing circuit for leaks. Replace the breathing circuit, if necessary. • Check the condition of the expiratory valve set. If anything is defective, replace.

Alarm	Definition	Action needed
Low ExpMinVol alarm off	<i>Low priority.</i> The operator-adjustable low ExpMinVol alarm is set to off.	No action required.
Low frequency	<i>Medium priority.</i> Measured fTotal is below the set alarm limit.	<ul style="list-style-type: none"> • Check patient condition. • Adjust the low fTotal alarm limit.
Low internal pressure <i>This alarm cannot be silenced – Audio Pause is disabled</i>	<p><i>High priority.</i> The internal reservoir pressure < 150 cmH2O for more than 3 seconds and one gas supply registers no pressure.</p> <p>The usual cause is loss of supply pressure.</p> <p>The ventilator enters the Ambient state.</p>	<ul style="list-style-type: none"> • Check patient condition. • Check the oxygen supply. Provide an alternative source of oxygen, if necessary. • Check the oxygen source/supply for potential leakage. • Provide alternative ventilation until the issue is resolved.
Low minute volume	<i>High priority.</i> Measured ExpMinVol is below the set alarm limit.	<ul style="list-style-type: none"> • Check patient condition. • Check the breathing circuit and artificial airway of the patient for leaks and/or disconnection. • Check and confirm settings, including alarms.
Low oxygen	<p><i>High priority.</i></p> <p>The measured oxygen is more than 5% (absolute) below the current Oxygen control setting.</p>	<ul style="list-style-type: none"> • Check patient condition. • Check the oxygen supply. Provide an alternative source of oxygen, if necessary. • Calibrate the O2 sensor. • Provide alternative ventilation and install a new O2 sensor. • If using a paramagnetic O2 sensor, calibrate the sensor or have the ventilator serviced.
Low PetCO2	<i>Medium priority.</i> PetCO2 is below the set alarm limit.	<ul style="list-style-type: none"> • Check patient condition. • Check the breathing circuit and flow sensor/artificial airway of the patient for leaks. • Check and confirm settings, including alarms.

Alarm	Definition	Action needed
Low pressure	<i>High priority.</i> Set pressure during inspiration not reached.	<ul style="list-style-type: none"> • Check patient condition. • Check the breathing circuit for a disconnection between the patient and the flow sensor, or for other large leaks.
Low tidal volume	<i>Medium priority.</i> Measured VTE is below the set limit for 2 consecutive breaths.	<ul style="list-style-type: none"> • Check patient condition. • Check and confirm settings, including alarms. • Check the breathing circuit and artificial airway of the patient for leaks, kinked tubing, or disconnection.
Maximum leak compensation	<i>Low priority.</i> A leak cannot be fully compensated. In APVsimv and APVcmv modes only.	<ul style="list-style-type: none"> • Inspect the system for leaks. • Suction the patient, if needed. • Ensure the high Pressure limit is appropriate. • Switch to a different ventilation mode.
O2 sensor calibration needed	<i>Low priority.</i> O2 sensor calibration data is not within expected range, or sensor is new and requires calibration.	<ul style="list-style-type: none"> • Calibrate the O2 sensor. • Verify temperature settings are within environmental specifications. • Replace O2 sensor if required. • Have the ventilator serviced. • If using a paramagnetic O2 sensor, calibrate the sensor or have the ventilator serviced.
O2 sensor defective	<i>Low priority.</i> The O2 sensor is depleted.	<ul style="list-style-type: none"> • Install a new O2 sensor. • If using a paramagnetic O2 sensor, calibrate the sensor or have the ventilator serviced.
O2 sensor missing	<i>Low priority.</i> There is no signal from the O2 sensor.	<ul style="list-style-type: none"> • Install an O2 sensor or use an external monitor, according to ISO 80601-2-55. • If using a paramagnetic O2 sensor, calibrate the sensor or have the ventilator serviced.

Alarm	Definition	Action needed
Oxygen + air supplies failed	<i>High priority.</i> Oxygen and air source flow is lower than expected.	<ul style="list-style-type: none"> • Check patient condition. • Check the oxygen supply. Provide an alternative source of oxygen, if necessary. • Check the oxygen source/supply for potential leakage. • Provide alternative ventilation until the issue is resolved.
Oxygen + heliox supplies failed	<i>High priority.</i> Oxygen and heliox source flow is lower than expected.	<ul style="list-style-type: none"> • Check patient condition. • Check the oxygen supply. Provide an alternative source of oxygen, if necessary. • Check the oxygen source/supply for potential leakage. • Provide alternative ventilation until the issue is resolved.
Oxygen alarm limit exceeded	<i>Medium priority.</i> Automatic oxygen adjustment exceeds the pre-set limits.	<ul style="list-style-type: none"> • Check patient condition. • Reset the alarm by touching the icon or the alarm buffer.
Oxygen supply failed	<i>High priority.</i> Oxygen source flow is lower than expected.	<ul style="list-style-type: none"> • Check patient condition. • Check the oxygen supply. Provide an alternative source of oxygen, if necessary. • Check the oxygen source/supply for potential leakage. • Provide alternative ventilation until the issue is resolved.
Panel connection lost	<i>Medium priority.</i> A problem has occurred with the communication between the monitor and the ventilator unit.	<ul style="list-style-type: none"> • Make sure that the monitor cable is securely connected to the ventilation unit. • If the problem persists, have the ventilator serviced.
Pressure limit changed	<i>Low priority.</i> Applies in ASV. The P ASV limit was changed. When this setting is changed, the device automatically adjusts the high Pressure alarm limit to 10 cmH2O above the specified P ASV limit setting.	Make sure the pressure limit is high enough so that sufficient pressure can be applied for adequate breath delivery.

Alarm	Definition	Action needed
Pressure low limit reached	<i>Low priority.</i> Inspiratory pressure, including PEEP/CPAP, is 10 cmH ₂ O below Pressure. The ventilator limits applied pressure, so the target pressure or volume may not be achieved.	<ul style="list-style-type: none"> • Check the patient for adequate ventilation. • Check and confirm settings, including alarms.
Pressure not released	<i>High priority.</i> Airway pressure has exceeded the Pressure limit, and the pressure was not released via the expiratory valve after 5 seconds. The ventilator enters the Ambient state.	<ul style="list-style-type: none"> • Check expiratory valve and breathing circuit for kinks and occlusions. • Provide alternative ventilation until the issue is resolved. • Have the ventilator serviced.
Reconnect external battery	<i>High priority.</i> Battery not connected.	Reconnect the external battery.
Remote communication error	<p><i>Only when connected to an external device using the HAMILTON-G5 / Block (ACK) protocol.</i></p> <p><i>Medium priority.</i> Communication with the external device is not functioning properly.</p>	<ul style="list-style-type: none"> • Check the cable connection to the COM port on the ventilator and the connection port on the device. • Consult the manufacturer's <i>Instructions for use</i> for details about resolving communication errors on the external device.
Remote communication timeout	<p><i>Only when connected to an external device using the HAMILTON-G5 / Block (ACK) protocol.</i></p> <p><i>Medium priority.</i> The ventilator has lost communication with the external device for at least 2 seconds.</p> <p>Connection to the external device is lost until the problem is resolved.</p>	<ul style="list-style-type: none"> • Check the cable connection to the COM port on the ventilator and the connection port on the device. • Consult the manufacturer's <i>Instructions for use</i> for details about resolving communication errors on the external device.
Technical fault: xxxxxx	<i>Technical fault.</i> A hardware or software issue was detected.	<ul style="list-style-type: none"> • Provide alternative ventilation until the issue is resolved. • Have the ventilator serviced.

Alarm	Definition	Action needed
Turn the flow sensor	<p><i>Medium priority.</i> Either the flow sensor is connected to the breathing circuit facing the wrong direction or the flow sensor connections to the ventilator are reversed.</p> <p>Ventilation continues, but the ventilator corrects for the reversed signal.</p>	<ul style="list-style-type: none"> • Check the flow sensor. The end marked PATIENT faces the patient. • Reverse the flow sensor tube connections on the ventilator. • The blue tube attaches to the blue connector. The clear tube attaches to the silver connector.
Volume limitation	<p><i>Medium priority.</i> The delivered volume exceeds the set volume limit.</p> <p>The ventilator limits delivered volume to the V limit setting.</p>	<ul style="list-style-type: none"> • Check patient condition. • Check and confirm settings.
Volume too low for nebulizer	<p><i>Low priority.</i> The pneumatic nebulizer was turned on, but it cannot operate because the ventilator settings would require > 50% of the tidal volume to be delivered by the nebulizer.</p>	<p>Check and adjust ventilator settings to increase inspiratory peak flow.</p>
Wrong flow sensor type	<p><i>High priority.</i> The type of flow sensor connected does not match the selected patient group.</p>	<ul style="list-style-type: none"> • Check the patient group selection. • Connect and calibrate the correct flow sensor.

9.5 Working with a distributed alarm system (DAS)

Before proceeding, review the safety information in Chapter 1.

WARNING

- Any distributed alarm system used with the ventilator *must* comply with IEC 60601-1-8:2006/A1:2012 Section 6.11.2.2.1. Any device that does not comply *cannot* be relied upon for the receipt of ventilator alarms.
- Ensure alarms are audible at your distributed alarm system monitoring device.
- Regularly check the patient and the ventilator when connected to a distributed alarm system.

NOTICE

The delay between the generation of an alarm and the transmission of that alarm to the connected DAS is less than 2 seconds.

A distributed alarm system (DAS) comprises a network of medical devices capable of detecting alarm conditions, sending generated alarms to one or more external monitoring devices, and displaying the alarms on these external devices, for example, at a central station.

The ventilator can be configured as a part of a distributed alarm system (DAS) using a COM port on the back of the ventilator.⁴² The COM port must be configured with the HAMILTON-G5 / Block (ACK) protocol.

When configured as part of a distributed alarm system, the HAMILTON-S1's audible alarm sound can be paused for an unlimited period of time, referred to as *global AUDIO OFF*.

When *global AUDIO OFF* is enabled, ventilator alarms are transmitted to other devices in the DAS, while the visual alarm indicators on the ventilator remain active (Section 9.1).

If you wish to pause the audible alarm on the ventilator, enabling *Global AUDIO OFF* comprises the following steps:

To ...	See ...
Connect ventilator to a DAS	Section 4.9 and the <i>Communication Interface user guide</i>
Select the communication protocol	Section 14.6.4
Enable <i>global AUDIO OFF</i>	Section 9.5.1

For details about the other devices in your distributed alarm system, see the associated manufacturer's *Instructions for Use*.

⁴² Not available in all markets.

9.5.1 Enabling global AUDIO OFF

To enable global AUDIO OFF, the ventilator must be connected to a remote device and the appropriate communication protocol must be selected.

To enable global AUDIO OFF

1. Open the Alarms > Loudness window.
 2. Select the global AUDIO OFF state checkbox (Figure 9-5).
- The text Ready for global AUDIO OFF is displayed in the message bar.
3. Press the Audio Pause key (Figure 9-1) to activate global AUDIO OFF.

The text global AUDIO OFF is displayed in the message bar. Most ventilator alarms are silenced. See Section 9.5.2 for alarms that still generate an audible alarm.

Figure 9-5. Enabling the global AUDIO OFF state

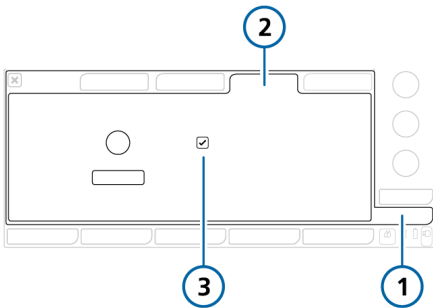

- | | |
|------------|--------------------------|
| 1 Alarms | 3 global AUDIO OFF state |
| 2 Loudness | |

To stop global AUDIO OFF and end the audio pause

- ▶ Press the Audio Pause key (Figure 9-1).

The audio pause on the ventilator is cancelled. All ventilator alarms generate an audible alarm.

9.5.2 About DAS-related alarms

WARNING

When an audio pause is active, the following critical alarms still generate an audible alarm:

- Apnea
- Apnea backup
- Air supply failed
- Oxygen supply failed
- Heliox supply failed
- Air and heliox supplies failed
- Oxygen and air supplies failed
- Oxygen and heliox supplies failed
- All gas supplies failed
- Low oxygen
- Check internal battery
- Internal battery low
- Internal battery empty
- Loss of mains power
- Low internal pressure
- SpO2 too low
- Panel connection lost
- Ventilator unit connection lost
- Remote communication error
- Remote communication timeout

Certain alarms still generate an audible alarm when **global AUDIO OFF** is enabled. When any of the above-listed alarms is generated, **global AUDIO OFF** is disabled, and the ventilator alarm sounds.

You must manually re-enable **global AUDIO OFF** as described next.

To resolve the alarm and enable global AUDIO OFF

1. Resolve the alarm condition (Table 9-2).
2. Press the Audio Pause key (Figure 9-1).

The text **global AUDIO OFF** is again displayed in the message bar. Ventilator alarms are silenced as described in Section 9.5.1.

The following ventilator alarms indicate a communication problem between the ventilator and the remote device:

- Remote communication timeout
- Remote communication error

For details about these alarms, see Table 9-2.

10

Ventilation settings and functions

10.1	Overview.....	210
10.2	Accessing settings during ventilation	210
10.3	Entering/exiting Standby	212
10.4	Oxygen enrichment.....	213
10.5	Manual breath	215
10.6	Inspiratory and expiratory hold	215
10.7	Working with a nebulizer	216
10.8	Locking and unlocking the touch screen.....	218
10.9	Capturing a screenshot	219
10.10	About the Event log	219
10.11	Setting display options	220

10.1 Overview

This chapter describes changing ventilation settings during active ventilation, as well as how to perform special functions on the ventilator.

Before proceeding, review the safety information in Chapter 1.

10.2 Accessing settings during ventilation

You can change patient data and ventilation control settings during ventilation, as needed.

10.2.1 Accessing patient data during ventilation

NOTICE

Changing the patient height automatically adjusts the following settings based on the recalculated IBW:

- Apnea backup setting (when set to Automatic)
- Safety mode startup values

Other settings and alarm limits are not adjusted.

During ventilation, the Patient window displays the basic patient profile, including sex, height, and ventilation time (Section 5.2).

When the ventilator is in Standby, the patient controls are accessible in the Standby window.

Note that if you are ventilating using the Last Patient setup, these controls are greyed out and unavailable.

To change patient data during ventilation

- ▶ Touch the **Patient** button to open the Patient window, and adjust settings as needed.

Figure 10-1. Patient window (Adult/Pediatric shown)

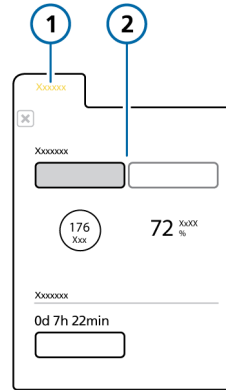

- | | |
|-----------|--|
| 1 Patient | 2 Adult/Pediatric: Gender and height, calculated IBW; Neonatal: Weight |
|-----------|--|

10.2.2 Accessing settings during ventilation

At any time during ventilation, you can adjust settings, as needed. Changes are applied immediately.

- Touch **Alarms** to access the alarm limit controls.
- Touch **Controls** to access the mode controls. Some controls are also available on the right side of the main display.
- Touch the **Modes** button to change the selected ventilation mode. Note that you can only select the Hi Flow O₂ and nCPAP-PS modes when in Standby.
- Touch the **Additions** button to access TRC and Sigh settings.
- Touch the **Patient** button to access patient settings.
- Touch the **IntelliCuff** or **Humidifier** icons to access the respective settings windows.

The ventilator monitor also provides access to key functions.

Keys on the front of the ventilator provide access to important functions, including entering Standby mode and pausing the audible alarm.

Figure 10-2. Function keys

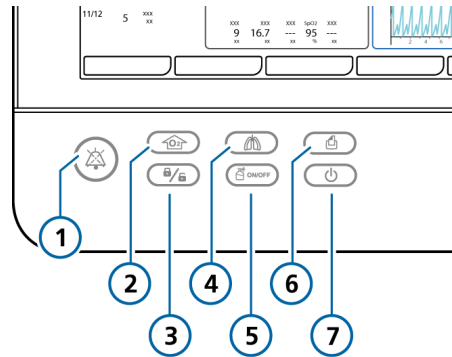

- | | |
|--|--------------------|
| 1 Audio Pause | 5 Nebulizer on/off |
| 2 O ₂ enrichment/
suctioning | 6 Print screen |
| 3 Screen lock/
unlock | 7 Standby |
| 4 Manual breath | |

10.3 Entering/exiting Standby

WARNING
When in Standby, the ventilator does *not* automatically resume ventilation when the patient is reconnected. You must manually restart ventilation.

NOTICE

- Patient alarms are suppressed in Standby.
- Acoustic patient alarms are suppressed for 1 minute after starting ventilation from Standby.

Standby is a waiting mode that lets you maintain ventilator settings while the ventilator is not performing any ventilatory functions.

To put the ventilator into Standby

1. Press and quickly release the Standby key while the ventilator is turned on (Figure 10-2).
The Activate Standby window (1) opens.

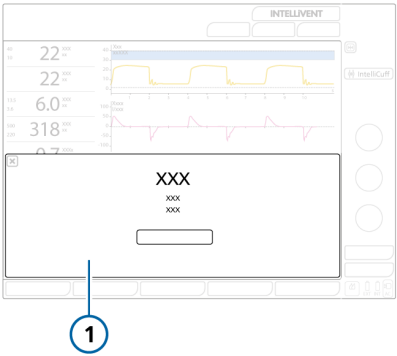

2. Touch **Activate standby**.
The Standby window opens (Figure 10-3).

When the device is in Standby, the Standby key backlight is orange.

While in Standby, the window shows the elapsed time the ventilator has been in Standby.

Figure 10-3. Standby window

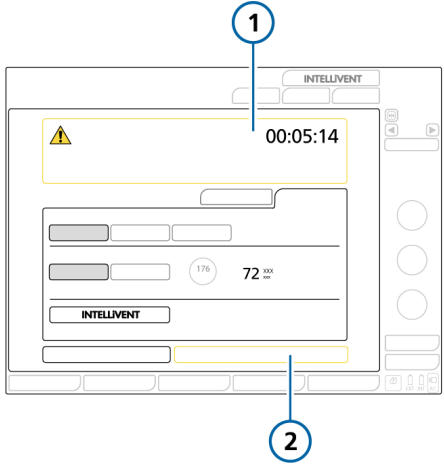

- | | |
|---------------------------|--|
| 1 Elapsed time in Standby | 2 Start (When Hi Flow O2 is selected: Start therapy) |
|---------------------------|--|

To end Standby and start ventilation

- ▶ Do either of the following:
 - Touch the **Start** button.
 If the mode selected is Hi Flow O2, the button is labeled **Start therapy**.
 - Press and quickly release the Standby key.

Ventilation resumes with the previous settings. During active ventilation, the Standby key backlight is white.

10.4 Oxygen enrichment

NOTICE

Oxygen alarms are suppressed while O2 enrichment is active.

Oxygen enrichment is useful before or after tracheal/endotracheal suctioning and for other clinical applications.

You can set the oxygen concentration to be delivered during O2 enrichment. For details, see Section 10.4.1.

To start oxygen enrichment

- ▶ Press the **O2** enrichment key (Figure 10-2).
After a short time, the ventilator starts delivering increased oxygen.

The device delivers the set oxygen level for 2 minutes. You can not change the set oxygen concentration when O2 enrichment is in progress.

When active, the O2 enrichment key backlight is green. In addition, the **Oxygen** control turns green and displays the currently applied concentration, with a countdown timer.



When finished, the ventilator resets the concentration to the previous operator-set value.

To stop O2 enrichment manually

- ▶ Do either of the following:
 - Press the **O2** enrichment key
Ventilation resumes at the previous operator-set oxygen concentration.
 - Change the O2 concentration using the **Oxygen** control
Ventilation resumes at the set oxygen concentration.

You can restore the O2 enrichment settings to the factory defaults, if desired.

10.4.1 Adjusting the oxygenation level for O2 enrichment

When using oxygen enrichment, you set the oxygen concentration to be delivered *in addition* to the current **Oxygen** setting. The setting can be stored as the default setting for the selected patient group (Section 14.10).

Note that the maximum delivered oxygen concentration will not exceed 100%. If the sum of the two settings is greater than 100%, the device delivers 100%.

Example

Current **Oxygen** setting: 50%

Additional O2 for enrichment setting: 40%

When you perform O2 enrichment by pressing the **O2** enrichment key, the ventilator increases the delivered oxygen to 90% for two minutes.

To change the O2 enrichment level

1. Before proceeding:
 - Decide on the total oxygen to deliver during enrichment.
 - Note the current **Oxygen** setting.
2. Open the System > O2 enrichment window (Figure 10-4).
3. Touch the **Additional O2 for enrichment** control and set it to the difference between your current **Oxygen** setting and the desired enrichment level.

During O2 enrichment, the sum of this control setting and the current **Oxygen** setting is delivered.

Figure 10-4. System > O2 Enrichment window

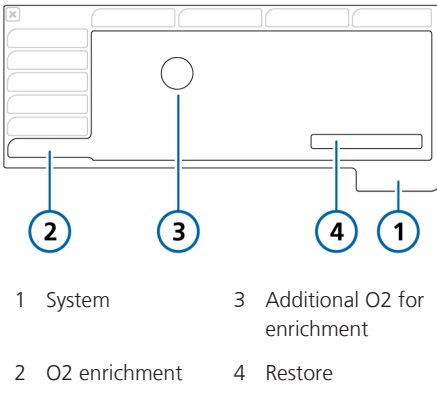

To revert to the default setting

- ▶ In the System > O2 enrichment window, touch **Restore** (Figure 10-4).

The Additional O2 for enrichment setting is reset to the configured default. For details about the control setting ranges and defaults, see Table 16-5.

10.4.2 Suctioning maneuver

The suctioning maneuver is intended to withdraw an excess of tracheal and/or bronchial secretions in the patient's airways while protecting the user from possible contamination, as well as ensuring the patient's safety during the suctioning maneuver. This section describes an open-suctioning maneuver.⁴³

Suctioning may affect measured values.

Note that suctioning is disabled:

- During Hi Flow O2
- When using NIV or NIV-ST modes

To perform the suctioning maneuver

1. Press the **O2 enrichment** key (Figure 10-2) for pre-oxygenation.
2. Disconnect the patient.

Disconnecting the patient stops ventilation so that no gases are blown through the breathing circuit. All alarms are suppressed for one minute.

3. Use a suctioning catheter (not included) to suction all secretions out of the patient's airway.
4. Reconnect the patient to the ventilator.

Post-oxygenation starts and all acoustic alarms are again suppressed for one minute. Alarm messages and alarm lamp are still active.

To stop the maneuver manually

- ▶ Press the **O2 enrichment** key again.

⁴³ A closed-suctioning maneuver is not described here since there is no breathing system disconnection.

10.5 Manual breath

You can deliver a manually triggered breath using the Manual breath key on the ventilator (Figure 10-2).

When active, the key backlight is green.

Note that manual breath is disabled in Hi Flow O2.

To deliver a manual breath

- ▶ Press and release the **Manual breath** key during exhalation.

The manual breath uses the mandatory breath settings (standard or operator set).

If you try to initiate a manual breath during the early stage of inspiration or the early stage of exhalation, the breath will not be delivered.

10.6 Inspiratory and expiratory hold

The ventilator supports both inspiratory and expiratory holds.

Note that holds are disabled in Hi Flow O2.

10.6.1 Inspiratory hold

An inspiratory hold closes the inspiratory and expiratory valves for a short time. Perform this maneuver to calculate true plateau airway pressure.

Figure 10-5. Hold window

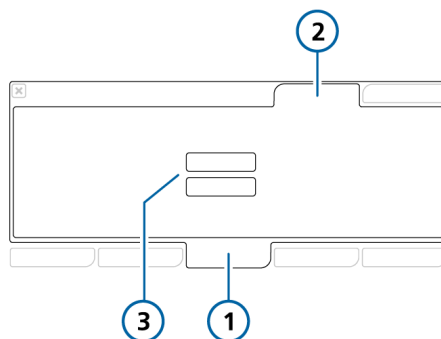

- | | |
|---------|--------------------------|
| 1 Tools | 3 Insp hold and Exp hold |
| 2 Hold | |

To perform an inspiratory hold

1. Open the **Tools > Hold** window.
2. Touch **Insp hold**.
The ventilator performs an inspiratory hold as follows:
 - **Adult/Pediatric**. 10-second hold
 - **Neonatal**. 3-second hold
 To stop the inspiratory hold early, touch the **Insp hold** button again. A progress timer appears for the length of the hold.
At the end of the hold, the window closes. The waveforms are frozen on the display.
3. Review the waveforms as appropriate.
4. Touch the **Freeze** button or press the P&T knob to unfreeze the display.

10.6.2 Expiratory hold

Perform this maneuver to measure the pressure within the patient airways and the patient’s effort and strength for inspiration. It is used to calculate intrinsic PEEP.

To perform an expiratory hold

1. Open the Tools > Hold window.
2. Touch **Exp hold**.
The ventilator performs an expiratory hold as follows:
 - **Adult/Pediatric**. 10-second hold
 - **Neonatal**. 3-second hold

To stop the expiratory hold early, touch the **Exp hold** button again.

A progress timer appears for the length of the hold.

At the end of the hold, the window closes. The waveforms are frozen on the display.
3. Review the waveforms as appropriate.
4. Touch the **Freeze** button or press the P&T knob to unfreeze the display.

10.7 Working with a nebulizer

The ventilator supports the use of both pneumatic and Aerogen nebulizers.

This section provides details about working with the nebulizer.

Table 10-1. Nebulization overview

For ...	See ...
Setting nebulization duration and breath cycle synchronization	Section 10.7.1
Pneumatic nebulization	Section 10.7.2
Aerogen nebulization	Section 10.7.3

10.7.1 Specifying duration and synchronization settings

You can specify for how long nebulization is active (*duration*) and when during the breath cycle it is delivered (*synchronization*). The settings can be stored as the default settings for the selected patient group (Section 14.10).

To select the nebulization duration

1. Open the System > Nebulizer window.
2. In the **Duration** section of the window, touch the **Duration** control and select a value between 5 and 40 minutes.
By default, duration is set to 30 minutes.
For an unlimited duration, that is, nebulization is active until you press the **Nebulizer** key again to stop it, select the **continuous** check box.

To specify synchronization options

You can change these settings at any time regardless of whether nebulization is active.

- ▶ In the System > Nebulizer window, touch the desired option in the Synchronization section of the window. The options are described in Table 10-2.

Table 10-2. Nebulizer synchronization options

Breath phase	The nebulizer medication is delivered ...
Inspiration	During patient inspiration
Exhalation	During patient exhalation
Insp. & Exh.	Continuously, during both inspiration and exhalation

10.7.2 Working with a pneumatic nebulizer

Before proceeding, review the safety information in Chapter 1.

Nebulization with a pneumatic nebulizer is available in all ventilation modes *except* Hi Flow O₂ and during neonatal ventilation.

For delivery of prescribed medications into the ventilator circuit, the ventilator provides a stable pressure source to power a standard inline pneumatic nebulizer connected to the Nebulizer port. The pressure delivered allows for an optimum flow of approximately 8 l/min.

By default, the ventilator automatically compensates the additional volume provided by the pneumatic nebulizer to deliver the set tidal volume. You can, however, disable this compensation, if required, in Configuration (Section 14.7).

Using the controls in the System > Nebulizer window, you can specify the duration of nebulization and breath cycle synchronization options (Section 10.7.1).

For effective nebulization, use a pneumatic nebulizer jar. For additional information about nebulizer use, including adding medication, refer to the manufacturer's instructions for use.

For connection and setup details, see Section 4.8.

To start and stop nebulization

1. Press the Nebulizer key (Figure 10-2). When active, the key backlight is green. The nebulizer flow, using 100% oxygen, is synchronized with the breathing phase specified in the System > Nebulizer window, for the specified duration (Section 10.7.1).
2. To stop nebulization at any time, press the Nebulizer key again. The key backlight turns white and nebulization stops.

10.7.3 Working with an Aerogen nebulizer

Before proceeding, review the safety information in Chapter 1 and the Aerogen Solo/Aerogen Pro Instructions for Use.

The Aerogen nebulizer system is available as an option. Nebulization with Aerogen is available for all ventilation modes⁴⁴.

You can use an Aerogen nebulizer for delivery of prescribed medications into the ventilator circuit. The nebulizer operates in-line with standard ventilator breathing circuits to aerosolize prescribed medications for inhalation without changing patient ventilator settings. It can be refilled without interrupting ventilation.

Using the controls in the System > Nebulizer window, you can specify the duration of nebulization and breath cycle synchronization options (Section 10.7.1).

For activation and setup details, see Section 4.8 and the Aerogen Solo/Aerogen Pro Instructions for Use.

To start and stop nebulization

1. Press the **Nebulizer** key (Figure 10-2).
The key backlight turns green when nebulization is active.
The nebulizer flow, using 100% oxygen, is synchronized with the breathing phase specified in the System > Nebulizer window, for the specified duration (Section 10.7.1).
2. To stop nebulization at any time, press the **Nebulizer** key again.
The key backlight turns white and nebulization stops.

During ventilation, the ventilator may generate the **Aerogen nebulizer disconnected** alarm. For details, see Section 9.4.

10.8 Locking and unlocking the touch screen

You can lock the touch screen to prevent inadvertent entries.

When screen lock is active:

- The key backlight is green.
- Touching the screen generates an audible beep and the message, **Screen lock active!**, is displayed.
- Some device controls remain available, while others are disabled, as follows:
 - **Active controls.** Audio Pause, Manual breath, O2 enrichment, Nebulizer
 - **Inactive controls.** Touch screen, Standby/Power, Print screen, P&T knob

To lock or unlock the screen

- ▶ Press the **Screen lock/unlock** key (Figure 10-2).

⁴⁴ Not available in all markets.

10.9 Capturing a screenshot

Before proceeding, review the safety information in Chapter 1.

The Print screen key saves a JPG file of the current ventilator display to a CompactFlash card or USB memory drive.

To capture a screenshot of the display

1. Do either of the following:
 - Insert a USB memory drive into the USB port (Figure 2-5).
 - Insert a CompactFlash card into the CompactFlash port.
2. Press the Print screen key (Figure 10-2) when the desired display is shown.

The device saves the image to the screenshots folder on the memory device. The key backlight is green while the device saves the image.

The filename uses the following format:

screenshot_yyyymmdd_hhmmss.jpg

where:

yyyy is the year
 mm is the month
 dd is the date
 hh is the hour (in 24-hour format)
 mm is the minute
 ss is the second

10.10 About the Event log

Once the ventilator is turned on, event logs collect data about clinically relevant ventilator activities, including alarms, technical notes, setting changes, calibrations, maneuvers, and special functions.

The date, time, and a unique identification reference (ID) for event classification is included.

Alarms are shown in color, depending on priority level (yellow for low or medium, red for high).

A more extensive log including technical and configuration details is available to service engineers.

When setting up a new patient:

- Data is appended to the existing event log when you select the **Last patient** tab.
- The event log is cleared and starts again when you select a different patient group tab (**Adult**, **Pediatric** or **Neonatal**).

Event log data persists after shutting off the ventilator or in the event of a power loss. When a log buffer is full, new events overwrite the oldest log entries.

To display the Event log

- ▶ Touch the **Events** button.

Event logs can be viewed as follows:

- Events > Settings window: Includes setting changes, calibrations, maneuvers, special functions, power ON/OFF
- Events > Alarms window: Includes all alarm-related messages
- Events > All events window: Includes a compilation of settings- and alarm-related messages

Figure 10-6. Events window

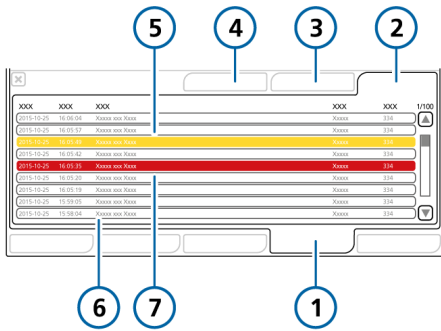

- | | |
|--------------|---------------------------------------|
| 1 Events | 5 Low-/medium-priority alarm (yellow) |
| 2 All events | 6 Informational message |
| 3 Alarms | 7 High-priority alarm (red) |
| 4 Settings | |

10.11 Setting display options

You can set the day and night display brightness, as well as the device date and time.

10.11.1 Setting date and time

You set the date and time for the ventilator in the System > Day/Night window. Ensure the date and time are set correctly so that event log entries have accurate time and date stamps.

To set the date and time

1. Open the System > Day/Night window (Figure 10-7).
2. Adjust the day and time, then touch **Apply** to save the changes.

Figure 10-7. Date and Time settings

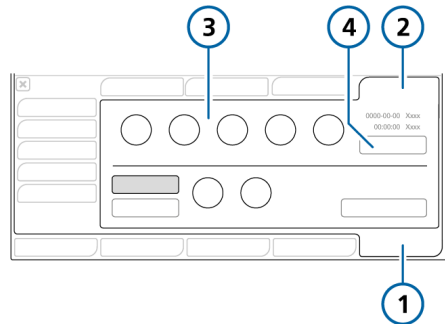

- | | |
|-------------|--------------------------|
| 1 System | 3 Date and time settings |
| 2 Day/Night | 4 Apply |

10.11.2 Day and night display brightness

Use these settings to set the brightness of the display for use during the day and night.

To set the display and alarm lamp brightness

1. Open the System > Day/Night window (Figure 10-8).
2. To select Day mode with a bright display, touch the **Day** button.
To select Night mode with a dimmer display, touch the **Night** button.
3. Adjust the brightness of the display and alarm lamp in each mode using the **Alarm Lamp** and Display controls. The setting you choose becomes the new default for that mode.

To set the Day/Night settings to the factory default, touch the **Restore** button.

Figure 10-8. Day/Night window

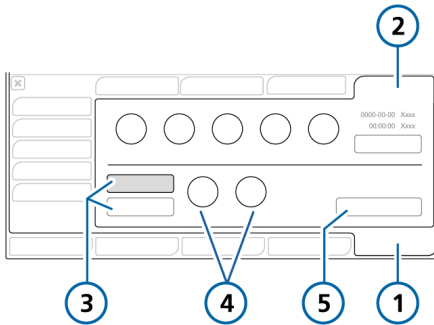

- | | |
|---------------------|--|
| 1 System | 4 Alarm lamp/Display brightness controls |
| 2 Day/Night | 5 Restore |
| 3 Day/Night buttons | |

Table 10-3. Day and Night settings

Setting	Brightness range	Default
Display, Day	25% to 100%	100%
Display, Night	25% to 100%	30%
Alarm Lamp, Day	20% to 100%	100%
Alarm Lamp, Night	20% to 100%	70%

11

Working with P/V Tool

11.1	Overview.....	224
11.2	Using the P/V Tool.....	225
11.3	Opening the P/V Tool.....	226
11.4	Adjusting the control settings.....	227
11.5	Performing a P/V Tool maneuver	228
11.6	Analyzing the data	232
11.7	Using reference curves	232
11.8	Performing a recruitment maneuver	233

11.1 Overview

P/V Tool™ and P/V Tool Pro are available for use with the HAMILTON-S1. This chapter describes the use of P/V Tool Pro.

P/V Tool Pro (referred to as *P/V Tool*) is a diagnostic and recruitment tool. It allows you to perform a maneuver to assess the total compliance for the entire respiratory system, including the lungs and the chest wall. Lung compliance is recorded in a quasi-static pressure volume curve.

P/V Tool helps the clinician:

- Determine the patient's lung characteristics and lung compliance.
- Define the maximum plateau pressure for ventilation.
- Determine the positive end expiratory pressure (PEEP) that will improve oxygenation, reduce end tidal CO₂, avoid alveoli collapse after a recruitment maneuver, and improve lung compliance.
- Perform a P/V Tool maneuver to assess the total compliance for the entire respiratory system, including the lungs and the chest wall. Lung compliance is recorded in a quasi-static pressure volume curve.
- Perform a recruitment maneuver to open or reinflate collapsed alveoli in the lungs.
- Define recruited volume and calculate when there is no longer extra lung to recruit.

11.1.1 Conditions for use

The following conditions must be met before performing a P/V Tool maneuver:

- The patient is intubated and passive, that is, *not* breathing spontaneously.
- The breathing circuit is gas tight.

There must be no gas leak throughout the entire system of the ventilator, the breathing circuit, or at the ventilated patient.
- Nebulization is deactivated.

P/V Tool is disabled during nebulization and for five breaths following nebulization.
- The flow sensor must perform optimally.

The accuracy of the information provided depends on the quality of the flow sensor connection. P/V Tool is disabled when the **Flow sensor calibration needed** alarm is active.
- P/V Tool is enabled in the following modes: (S)CMV, SIMV, APVcmv, APVsimv, P-CMV, P-SIMV, DuoPAP, APRV, ASV, and INTELLiVENT-ASV.
- P/V Tool is disabled in the following modes: SPONT, NIV, VS, NIV-ST, nCPAP-PS, Apnea backup modes, and Hi Flow O₂.
- The patient has received at least five breaths between P/V Tool maneuvers.
- P/V Tool option is activated on the ventilator.

11.1.2 Indications for use

Use of the P/V Tool is indicated for adult, pediatric, and neonatal patients provided that the required conditions are met as described in Section 11.1.1.

11.1.3 Contraindications for use

Use of the P/V Tool is contraindicated if any of the following conditions apply:

- Patients with unstable cardiovascular dynamics
- Patients with confirmed or suspected intracranial hypertension
- Patients who cannot tolerate high intrapulmonary pressure
- Patients vulnerable to barotrauma or volutrauma

11.2 Using the P/V Tool

Before proceeding, review the information in Sections 11.1.1 through 11.1.3.

Using the P/V Tool involves the following steps:

To ...	See ...
Open the P/V Tool	Section 11.3
Adjust control settings	Section 11.4
Perform a P/V Tool maneuver	Section 11.5
View the data	Section 11.5.1
Use reference curves	Section 11.7
Perform a recruitment maneuver	Section 11.8

Using the P/V Tool does not require any disconnection of the breathing circuit or changes to ventilation settings.

You can use the P/V Tool during active ventilation.

11.3 Opening the P/V Tool

To open the P/V Tool

1. Touch **Tools**, then **P/V Tool**.

2. Review the safety information, then touch **OK** to continue.

The P/V Tool window opens (Figure 11-1).

Figure 11-1. P/V Tool window

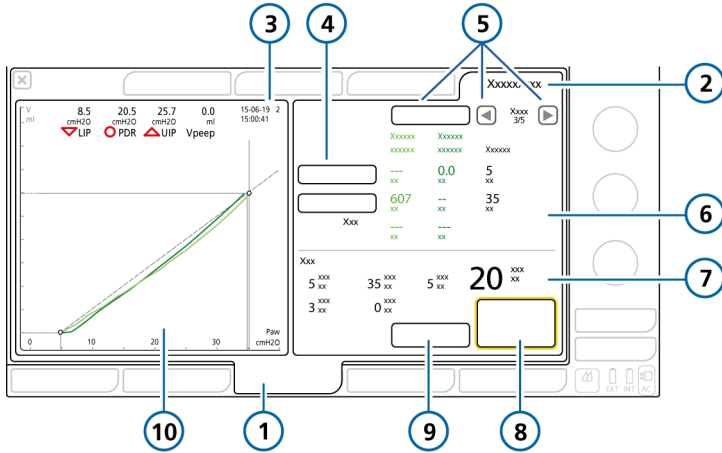

- | | | | |
|---|--|----|---------------------------------|
| 1 | Tools | 6 | Numerical data related to graph |
| 2 | P/V Tool | 7 | Current settings |
| 3 | Date and time of maneuver | 8 | Start/Stop maneuver |
| 4 | Cursors 1 and 2 | 9 | Settings |
| 5 | Reference button and history navigation arrows | 10 | P/V Tool graphics panel |

The next step is to adjust the control settings.

11.4 Adjusting the control settings

NOTICE

- Set **Ptop** to a low value to prevent generation of excessive volumes when performing a maneuver on patients with obstructive “soft lung” diseases, such as COPD.
- Set a low ramp speed to ensure accurate data when performing a P/V Tool maneuver. The ramp speed also dictates the length of the maneuver.

You can configure the control parameters listed in Table 11-1 for a P/V Tool maneuver.

To adjust control settings

1. In the P/V Tool window, touch the **Settings** button.
The Settings window opens (Figure 11-2).
2. Review and, if needed, adjust the settings.
The controls **Ptop**, **Tpause**, and **End PEEP** may require extra steps when adjusting them, as described in the following sections.

Table 11-1. P/V Tool control settings

Control	Description
Pstart (cmH2O)	Starting pressure. Default value: Current PEEP
Ptop (cmH2O)	Target high pressure during the maneuver. Default value: 35
End PEEP (cmH2O)	End pressure and PEEP to be applied after the maneuver. Default value: Current PEEP
Ramp speed (cmH2O/s)	Rate of pressure change; the time taken to reach the target pressure. Default value: 3
Tpause (s)	Length of the pause during the P/V Tool maneuver; time during which the target pressure will be applied. Default value: 0
Tmaneuver (s)	The length of the maneuver. This is a calculated value based on the settings of the above-listed controls. Default value: --

Figure 11-2. P/V Tool control settings

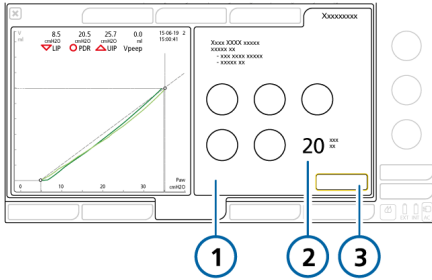

- 1 Control settings (Table 11-1)
- 2 Calculated Tmaneuver value
- 3 Close

To set Ptop > 40 cmH2O or Tpause > 5 seconds

1. Touch the appropriate control to activate it and set it to the maximum allowed value (40 for Ptop, 5 for Tpause).
2. Press the P&T knob to accept the setting.
3. To set either parameter beyond this limit, touch the control again and turn the P&T knob to set the value as desired.
4. Press the P&T knob to accept the changed value.

To set End PEEP to a different setting than PEEP/CPAP

1. If setting End PEEP to a different value than PEEP/CPAP, the device prompts you to confirm the new setting.
2. Touch **Yes** or **No** to confirm the setting.

The next step is to perform a P/V Tool maneuver. See Section 11.5.

11.5 Performing a P/V Tool maneuver

NOTICE

To avoid the risk of infection, if Intelli-Cuff is connected and being used, prior to performing a recruitment maneuver, inflate the cuff pressure controller to keep the airway tight.

To perform a P/V Tool maneuver

1. Touch the **Start/Stop maneuver** button.
The device performs a recruitment maneuver for the length of time defined by the settings.
2. To stop the P/V Tool maneuver early, touch the **Start/Stop maneuver** button.
At the end of the P/V Tool maneuver, ventilation continues and the results of the maneuver are displayed. See Figure 11-1.

The next step is to review the resulting data.

11.5.1 Viewing data

Data gathered during the P/V Tool maneuver is displayed both graphically and numerically.

To ...	See ...
Choose the data to display	Section 11.5.2
Display numerical data	Section 11.5.2.1
Analyze the curves	Section 11.6
Use a previous curve as reference for comparison	Section 11.7

11.5.2 Choosing the data to display

You can select from the following graph types:

Table 11-2. P/V Tool graph types

Graph type	Description
Paw/V	Airway pressure to airway volume. The airway pressure in relation to the lung volume. It shows how much pressure is required to inflate the lung at each volume step. See Figure 11-3.
Paw/V + Paw/dV	Airway pressure to airway volume and the difference in airway volume between the inspiratory limb and the expiratory limb. When this view is selected, the difference in airway volume values are displayed in orange on the right side of the P/V Tool window. See Figure 11-4.
Paw/Flow	Airway pressure to airway flow. See Figure 11-5.
Pes (Paux)/V	Pressure measured through the Paux port to airway volume. See Figure 11-6.
Ptranspulm/V	Transpulmonary pressure (Paw - Paux) to airway volume. See Figure 11-7.

To select a graph

1. Touch the P/V Tool graphics panel.
The graph selection list opens, displaying the available options (Table 11-2).
2. Select the desired option from the list using the P&T knob.

The window closes and the selected graph is displayed.

Figure 11-3. Paw/V graph

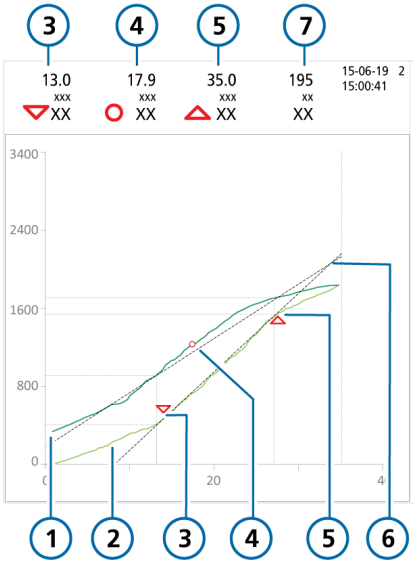

- 1 Deflation limb (dark green)
- 2 Inflation limb (light green)
- 3 ▽ Lower inflection point (LIP)
- 4 ○ Point of de-recruitment (PDR)
- 5 △ Upper inflection point (UIP)
- 6 Guidelines between points
- 7 Vpeep (inflated lung volume when the set PEEP is reached)

Figure 11-4. Paw/V + Paw/dV (1) graph

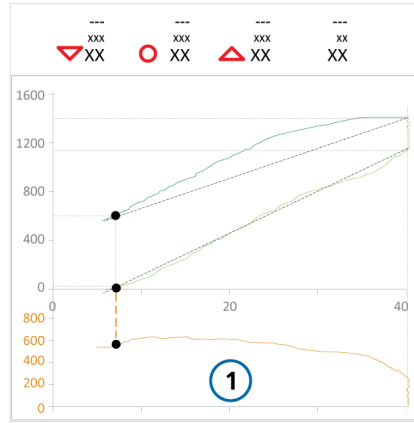

Figure 11-5. Paw/Flow graph

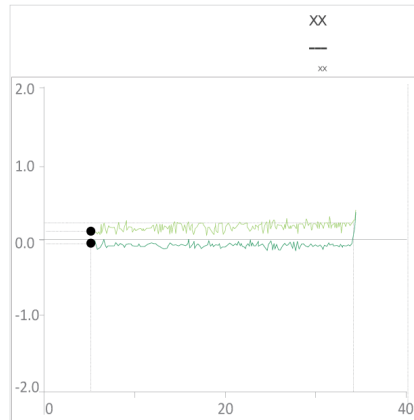

Figure 11-6. Pes (Paux)/V graph

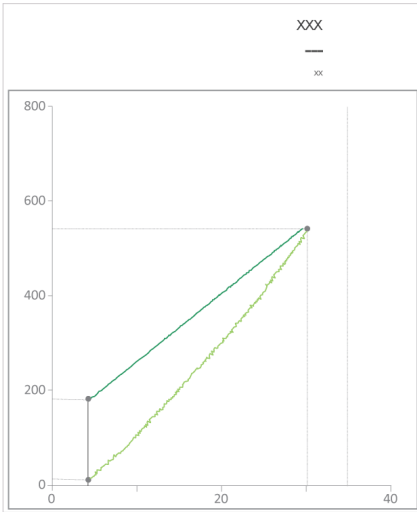
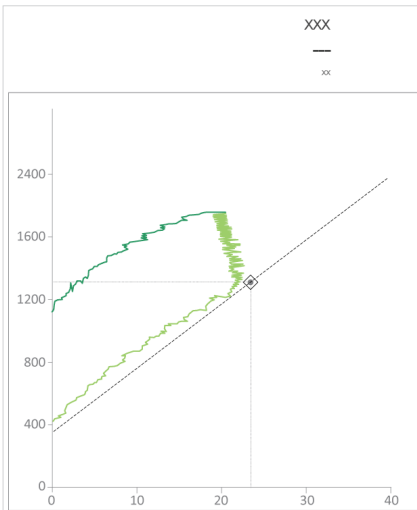

Figure 11-7. Ptransplm/V graph



11.5.2.1 Numerical data

Data is also displayed numerically (Figure 11-8).

The data is dynamic. Depending on what you select in the P/V Tool window, values will change, allowing you to analyze data based on precise values.

For parameter specifications, including ranges and accuracy, see Table 16-6.

Figure 11-8. Reviewing the data

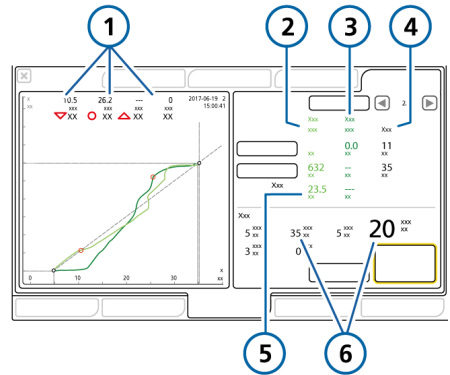

- | | |
|--|------------------------|
| 1 LIP, UIP, PDR, Vpeep values
<i>Includes dV when an appropriate graph is selected.</i> | 4 Airway pressure data |
| 2 Inflation limb data (light green) | 5 Compliance |
| 3 Deflation limb data (dark green) | 6 Current settings |

11.6 Analyzing the data

Once the P/V Tool maneuver is complete, the inflation and deflation limbs of the maneuver are displayed in the P/V Tool graphics panel.

Use the cursors to move up and down the recorded curves to analyze in precise detail the recorded values on the inflation and deflation limbs.

To move the cursors

1. Touch the **Cursor 1** or **Cursor 2** button (Figure 11-1).
2. Move the cursor using the P&T knob. The displayed data is automatically updated as you move the cursor.
3. Touch the button again to deselect the cursor.

11.7 Using reference curves

The reference curve is used to compare a patient's progress over time or before and after a recruitment maneuver.

Between 3 and 20 curves can be stored depending on the length of the stored maneuvers. The oldest curves are deleted as new recruitment maneuvers are performed.

You can select one inflation/deflation curve as the reference curve, which you can change at any time. This curve is overlaid in the P/V Tool graphics panel.

Stored settings, reference curves, and data are deleted when the device is restarted or when you start ventilation with a new patient.

Figure 11-9. Displaying a reference curve

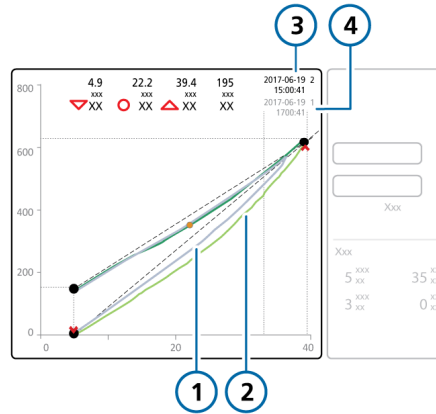

- | | |
|--------------------------|--|
| 1 Reference curve (gray) | 3 Time and date associated with the current (green) curve |
| 2 Current curve (green) | 4 Time and date associated with the reference (gray) curve |

To display a reference curve

1. Touch the left or right navigation arrow keys (Figure 11-1) to scroll through the stored curves. As you scroll through the stored curves, each curve is displayed in gray in the P/V Tool graphics panel (Figure 11-9).
2. Touch the **Reference** button to set the displayed curve as the reference.

The reference curve is displayed in gray. The current inflation limb, deflation limb, and associated values are displayed in green.

To deselect a reference curve

- ▶ Touch the **Reference** button again to deselect a reference curve.

11.8 Performing a recruitment maneuver

The P/V Tool can also be used to perform a recruitment maneuver. For details, see Section 11.5.

Set **P_{top}** to the desired pressure to perform a recruitment maneuver. The duration for the maneuver is determined by the P/V Tool control settings (Table 11-1).

Upon completion of the recruitment maneuver, the resulting graph shows the volume of the lung that has been recruited.

12

Working with external devices

12.1	Working with the HAMILTON-H900 humidifier	236
12.2	Working with IntelliCuff.....	245

12.1 Working with the HAMILTON-H900 humidifier

Before proceeding, review the safety information in Chapter 1.

Using the HAMILTON-H900 humidifier with the ventilator offers full integration of humidifier monitoring data and controls directly from the ventilator display.^{45,46} In addition, functions between the devices are synchronized.

You can control the humidifier both from the ventilator or on the humidifier itself.

This section describes using the ventilator to manage and monitor humidifier settings.

For detailed information about the settings, specifications, patient set up, humidifier operation, humidifier configuration, and important safety information, see the *HAMILTON-H900 Instructions for use*.

Table 12-1. Operation overview

For details about ...	See ...
Enabling the Humidifier option on the ventilator	Section 14.11.3
Accessing humidifier controls on the ventilator	Section 12.1.1
Humidifier modes	Section 12.1.2
Changing humidity using temperature controls	Section 12.1.3
Entering Standby	Section 12.1.4
Turning the humidifier on/off	Section 12.1.5
Humidifier-related alarms	Section 12.1.6
Humidifier-related parameters	Section 12.1.7

⁴⁵ Supported for HAMILTON-H900 version 0.1.0.5b and later.

⁴⁶ Not available in all markets.

12.1.1 Accessing humidifier controls on the ventilator

The System > Humidifier window shows a visual representation of the breathing circuit, clearly indicating the inspiratory gas temperature at the water chamber exit and at the patient. It also provides access to the operations listed in Table 12-1.

To open the Humidifier window

- ▶ Do either of the following (Figure 12-1):
 - Touch the **Humidifier** icon.
 - Touch **System > Humidifier**.

If communication between the humidifier and the ventilator is lost, the window is disabled.

Figure 12-1. System > Humidifier window

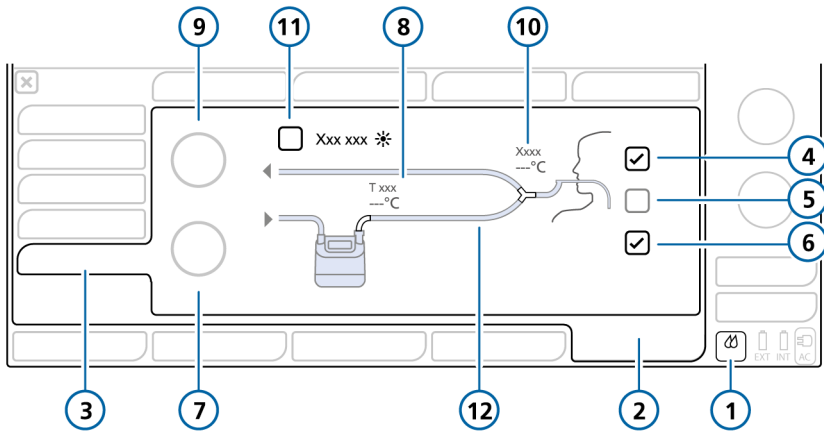





1	Humidifier icon	7	Set temp control
2	System	8	T humidifier
3	Humidifier	9	T gradient control
4	On	10	T y-piece
5	NIV	11	Exp. temp increase checkbox
6	Auto	12	Breathing circuit

12.1.1.1 About the Humidifier button

The **Humidifier** button at the bottom right of the display provides quick access to the Humidifier window and indicates the state of the humidifier, including whether any alarms are active and the current humidifier temperature.

Table 12-2. Humidifier button icon states

Icon state	Description
	<i>Full, black.</i> Humidifier is not connected. If no icon is displayed, this option is not available in your country or is not installed.
	<i>Full, gray.</i> Humidifier is connected but turned off.
	<i>Full, white.</i> Humidifier is connected and turned on.
	<i>Yellow.</i> Humidifier is connected and a low- or medium-priority humidifier alarm is active.
	<i>Red.</i> Humidifier is connected and a high-priority humidifier alarm is active.

12.1.2 About the humidifier operating modes

The Humidifier window offers the following modes: **Invasive** and noninvasive (**NIV**), for which you can use either automatic (**Auto**) or manual settings.

Further, the humidifier matches the operating status of the ventilator. If ventilation is active, the humidifier is running. If the ventilator is in Standby, the humidifier automatically enters Standby.

12.1.2.1 Invasive and NIV modes

This mode selection determines the initial temperature settings, both at the water chamber exit (**Set temp**) and at the Y-piece (**T gradient**), as well as the allowed temperature ranges for each of these controls.

The **Invasive** mode allows for a higher temperature range than the **NIV** mode. For details about the humidifier settings and ranges, see the *HAMILTON-H900 Instructions for use*.

When connected to the ventilator, the humidifier *automatically* matches the mode selection to the type of ventilation mode selected on the ventilator. For example, when the mode on the ventilator is invasive, such as ASV, the humidifier is automatically set to **Invasive** mode.

The System > Humidifier window displays a breathing circuit diagram that reflects the selected humidifier mode.

Figure 12-2 shows the **Invasive** mode selected; Figure 12-3 shows the **NIV** mode selected.

You can change the humidifier mode at any time.

Note that any time the humidifier changes from one mode to another, it also automatically switches to **Auto** settings and loads the configured default settings for the newly selected humidifier mode.

12.1.2.2 Auto and Manual control settings

The water chamber exit temperature and temperature gradient are set using either of the following methods:

- Loaded from the configured default settings on the humidifier (**Auto** mode)
- Set manually by the operator (**Manual** mode)

When set to **Auto**, the temperature controls in the System > Humidifier window are disabled. You must first enable **Manual** mode to change any settings. To enable **Manual** mode, deselect the **Auto** mode checkbox.

In both cases, the humidifier automatically controls the temperatures to reach the specified settings.

Automatic settings (Auto)

When set to **Auto**, the humidifier loads the associated default settings specified for the selected humidifier mode in its configuration and uses them to control the gas temperature.

In **Auto** mode, the temperature controls in the ventilator System > Humidifier window are grayed out (disabled), but they display the configured **Auto** settings (Figure 12-2).

For details about these settings, see the *HAMILTON-H900 Instructions for use*.

Figure 12-2. Auto mode

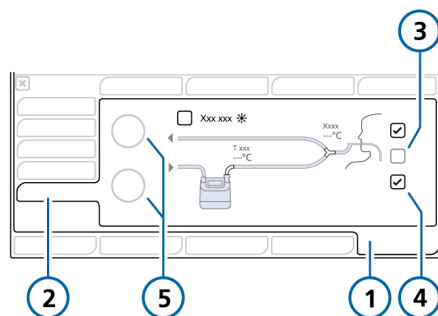

- | | |
|--|--|
| 1 System | 4 Auto |
| 2 Humidifier | 5 Disabled controls showing the configured Auto temperature settings |
| 3 Invasive (NIV checkbox not selected) | |

Manual settings

When set to **Manual**, you set the chamber exit temperature (**Set temp**) and temperature gradient values (**T gradient**) within the allowed ranges for each mode (**Invasive** or **NIV**).

The temperature controls in the ventilator System > Humidifier window are enabled (Figure 12-3).

You can change settings both in the System > Humidifier window as well as directly on the humidifier. When you change values on the humidifier, the values are also reflected on the controls in the System > Humidifier window.

Note that changing the mode between **Invasive** and **NIV** or vice versa automatically switches the control settings to **Auto** mode.

Figure 12-3. Manual mode

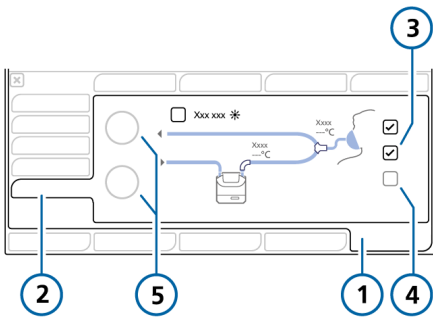

- 1 System
- 2 Humidifier
- 3 NIV
- 4 Manual (Auto not selected)
- 5 Available temperature controls

12.1.3 Changing humidity using temperature controls

You can adjust the following controls on either device:

Table 12-3. Adjustable humidifier controls

Control	Description
Set temp	Temperature at the water chamber exit. The possible range of values for this control depends on the selected humidifier operating mode: Invasive or noninvasive (NIV). Higher values result in higher absolute humidity.
T gradient	The difference between the temperature at the water chamber exit and at the Y-piece. A higher value decreases condensation.
Exp. temp increase	When selected, the humidifier provides additional heat in the expiratory limb to reduce condensation.

In a way, the **Set temp** and **T gradient** parameters are linked. The maximum allowed temperature at the patient (Y-piece) is 42°C. The combination of the values set for these two parameters cannot exceed this limit.

For example, if **T gradient** is set to 2°C, the highest possible setting for **Set temp** in the **Invasive** mode is 40°C.

Note, however, that the **T gradient** setting takes precedence over the **Set temp** value. For example, if **Set temp** is set to 40°C, you can set **T gradient** to 3°C even though the combination exceeds 42°C. Once the **T gradient** setting is accepted, the **Set temp** value automatically resets to 39°C.

To manually specify humidifier settings

- ▶ Do either of the following:
 - In the System > Humidifier window on the ventilator, activate **Manual** mode by deselecting the **Auto** checkbox, then select the desired **Set temp** and **T gradient** values.
 - Change the chamber exit temperature or temperature gradient directly on the humidifier.

The changes are applied immediately.

To reduce condensation in the expiratory limb

- ▶ Increase the expiratory limb temperature by touching the **Exp. temp increase** button.
 - A checkmark indicates it is selected.

For details about working directly on the humidifier, see the *HAMILTON-H900 Instructions for use*.

12.1.4 Entering Standby

The humidifier automatically enters Standby mode when the ventilator enters Standby.

12.1.5 Turning the humidifier on/off

You can turn the humidifier on or off both from the ventilator and from the device itself.

When you connect the humidifier to the ventilator, the humidifier assumes the same state as the ventilator.

That is, if the ventilator is in Standby, the humidifier is as well. If the ventilator is in active ventilation, the humidifier starts operation immediately.

To turn off the humidifier from the ventilator

- ▶ In the System > Humidifier window, turn off the humidifier by deselecting the **On** button (Figure 12-1).

The **On** button does not contain a checkmark and all of the controls in the window are disabled.

To turn the humidifier back on from the ventilator

1. In the System > Humidifier window, touch the **On** button to turn on the humidifier.
 - A checkmark indicates the humidifier is On.
2. Check the mode and settings, and adjust if needed.

When you start ventilation, the humidifier starts automatically.

12.1.6 About humidifier-related alarms

Humidifier-related alarm messages are indicated in the following locations:

- On the humidifier, graphically
- Alarm message on the ventilator main display
- The **Humidifier** icon changes color (Table 12-2)
- In the System > Humidifier window on the ventilator

The alarms listed here may not be comprehensive. Be sure to review the *HAMILTON-H900 Instructions for use* for details and troubleshooting information.

Figure 12-4. Humidifier-related alarm indicators on ventilator (showing high-priority alarm)

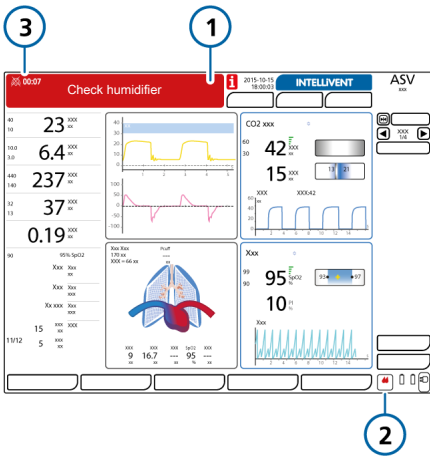

- | | |
|---------------------|-------------------------|
| 1 Alarm message bar | 3 Audio Pause indicator |
| 2 Humidifier icon | |





To pause the audible humidifier alarm



- ▶ Touch the **Audio Pause** key on either the ventilator or the humidifier.

Note that touching the **Audio Pause** key on the ventilator also temporarily silences the alarm on the humidifier.

Table 12-4 lists the humidifier-related alarms shown on the ventilator and the associated graphical presentation on the humidifier.

Table 12-4. Humidifier alarms

Alarm text on ventilator	Alarm icon on HAMILTON-H900	Description
Humidifier tilt <i>High priority.</i>		<ul style="list-style-type: none"> • Humidifier dangerously inclined. • The humidifier is at a 10° angle or higher relative to the floor.
Humidifier chamber temp high Humidifier Y-piece temp high <i>High priority.</i>		<ul style="list-style-type: none"> • Temperature too high. • The gas temperature at the water chamber exit or at the Y-piece is above the set value.
Humidifier water high <i>High priority.</i>		<ul style="list-style-type: none"> • High water level in the water chamber. • The water level in the water chamber is above the maximum level mark.
Check humidifier <i>High and medium priority.</i> <i>Displayed on the ventilator only.</i>	n/a	<ul style="list-style-type: none"> • When the alarm is related to something other than the humidifier alarms listed in this table, the ventilator displays this text. • Check humidifier operation and all connections.
Check communication interface humidifier <i>Low priority.</i> <i>On the ventilator only.</i>	n/a	<p><i>Note that the humidifier information in the ventilator System > Humidifier window is absent, and the Humidifier quick access button is grayed out.</i></p> <ul style="list-style-type: none"> • There is a problem with the connection between the humidifier and the ventilator. • Ensure that the humidifier communication cable is securely connected to the humidifier and to the humidifier port on the ventilator. • Open the alarm buffer by touching the message bar or the i-icon, if displayed, to reset the alarm.
Humidifier chamber temp low Humidifier Y-piece temp low <i>Medium priority.</i>		<ul style="list-style-type: none"> • Temperature too low. • The gas temperature at the water chamber exit or at the Y-piece is below the set value.

Alarm text on ventilator	Alarm icon on HAMILTON-H900	Description
Humidifier water low <i>Medium priority.</i>		<ul style="list-style-type: none"> • Low water level in the water chamber. • The water level in the chamber is below the low level mark. The water level in the chamber is low.
Humidifier check chamber <i>Medium priority.</i>		<ul style="list-style-type: none"> • No chamber or invalid water chamber inserted. • The chamber is either missing, incorrectly inserted, or is incompatible.
Humidifier check left tube Humidifier check right tube <i>Medium priority.</i>		<ul style="list-style-type: none"> • No tube or defective tube connected. • A circuit limb is not properly connected.

12.1.7 About humidifier-related parameters

Humidifier data is displayed in the following locations:

- Monitoring > 2 window
- System > Humidifier window
- As an MMP (if configured)
- As an SMP

The following parameters are related to humidifier operation.

Table 12-5. HAMILTON-H900-related parameters

Parameter	Description
Set temp	Control parameter. See Table 12-3.
T humidifier	<p>Monitored parameter.</p> <p>Measured temperature at the water chamber exit.</p> <p>Displayed in Monitoring > 2 window, as an SMP, and in the System > Humidifier window.</p> <p>In Configuration, this parameter can be set as an MMP.</p>
T gradient	Control parameter. See Table 12-3.
T y-piece	<p>Measured temperature at the Y-piece.</p> <p>Displayed in System > Humidifier window.</p>
Exp. temp increase	Control parameter. See Table 12-3.

12.2 Working with IntelliCuff

The ventilator offers integrated monitoring and control of IntelliCuff⁴⁷.

This integration allows you to view key monitoring data and to control IntelliCuff operation and settings directly from the IntelliCuff window on the ventilator display.

For detailed information about IntelliCuff intended use, setup, operation, and specifications, see the *IntelliCuff Instructions for use*.

For setup details, see Section 4.4.

The following sections describe how to control the integrated IntelliCuff cuff pressure controller from the ventilator.

Table 12-6. IntelliCuff operations available on the ventilator

To ...	See ...
Enable IntelliCuff in Configuration on the ventilator	Section 14.11.3
Access IntelliCuff controls on the ventilator	Section 12.2.1
Turn IntelliCuff on or off	Section 12.2.2
Select the settings control mode (Auto/Manual)	Section 12.2.3
Adjust the pressure	Section 12.2.4
Deflate the cuff	Section 12.2.5

⁴⁷ Supported for IntelliCuff version 1.0.2.2 and later.

12.2.1 Accessing IntelliCuff controls on the ventilator

The IntelliCuff window displays the cuff pressure setting and current value. It also provides access to the operations listed in Table 12-6.

To open the IntelliCuff window

1. Connect IntelliCuff, including the cuff tubing.

The IntelliCuff window is available when the device is enabled in Configuration, regardless of whether IntelliCuff is turned on or off.

2. Open the IntelliCuff window by doing either of the following:
 - Touch the **IntelliCuff** icon (Section 12.2.1.1)
 - Touch **System > IntelliCuff**.

Figure 12-5. System > IntelliCuff window

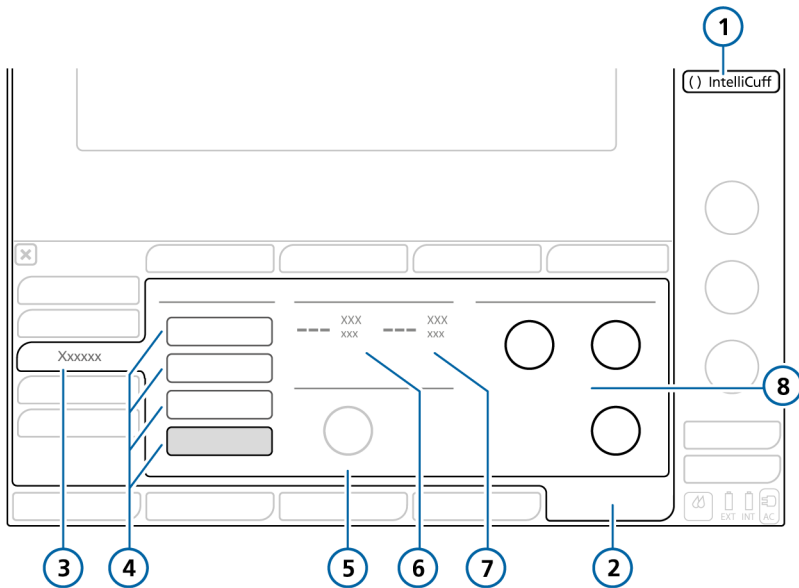

1	IntelliCuff button	5	Cuff pressure control
2	System	6	Pcuff
3	IntelliCuff	7	Ppeak
4	Deflate, Off, Manual, Auto	8	Pressure controls: Relative (Rel. pressure), Minimum (Min. pressure), Maximum (Max. pressure)

12.2.1.1 About the IntelliCuff button

The **IntelliCuff** button at the upper right side of the display provides quick access to the IntelliCuff window and indicates the state of the controller, including whether any alarms are active.

When Heliox is active, the **IntelliCuff** button decreases in size and displays only the cuff indicator.



Table 12-7. IntelliCuff button icon states

Icon state	Description
	<i>Black, grayed out.</i> IntelliCuff is not enabled. See Section 14.8.
	<i>Gray, Cuff is empty.</i> IntelliCuff is connected, turned off.
	<i>White.</i> IntelliCuff is connected, operational. If IntelliCuff is off or deflated and a high- or medium-priority alarm occurs, this icon is shown in the same color as the alarm priority (red or yellow).
	<i>Yellow.</i> IntelliCuff is connected and a low- or medium-priority IntelliCuff-related alarm is active.
	<i>Red.</i> IntelliCuff is connected and a high-priority IntelliCuff-related alarm is active.

12.2.2 Turning IntelliCuff on and off

The integrated IntelliCuff is always connected, but must be turned on or off from the IntelliCuff window on the ventilator.

By default, the device is off when starting the ventilator and setting up a new patient.

When choosing the **Last patient** setting in Standby, all IntelliCuff controls (**Cuff pressure**, **Rel. pressure**, **Min. pressure**, **Max. pressure**, and the selected mode) are set to the last-used selections. Note that if IntelliCuff is turned off and restarted, the default settings are used instead.

Before turning off the ventilator, you must deflate the cuff and turn off IntelliCuff.

To turn IntelliCuff ON from the ventilator

- ▶ In the System > IntelliCuff window, touch **Auto** or **Manual** (Section 12.2.3).

IntelliCuff starts with the settings as specified in the window.

To turn IntelliCuff OFF from the ventilator

- ▶ In the System > IntelliCuff window, touch **Off** (Figure 12-5).

When turned off, the cuff pressure is not released, but any cuff leakage is no longer compensated and all related alarms are disabled.

12.2.3 About IntelliCuff modes

The HAMILTON-S1 ventilator offers the ability to control the cuff pressure manually or automatically.⁴⁸

To select the mode to use

- ▶ In the System > IntelliCuff window, touch **Auto** or **Manual** (Figure 12-5).

12.2.3.1 Manual mode

In Manual mode, you set the desired cuff pressure directly (Section 12.2.4). IntelliCuff maintains this pressure at a constant rate independent of the current airway pressure.

During recruitment maneuvers, the cuff pressure is set automatically (Section 12.2.4.1).

Figure 12-6. System > IntelliCuff window, Manual mode

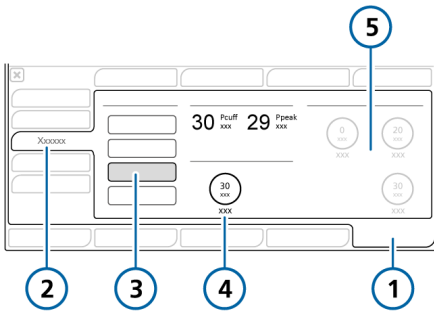

- | | |
|---------------|---|
| 1 System | 4 Cuff pressure control |
| 2 IntelliCuff | 5 Disabled controls showing the configured Auto pressure settings |
| 3 Manual | |

12.2.3.2 Auto mode

In Auto mode, the device adjusts cuff pressure dynamically to remain at the desired pressure within the set limits.

You specify the desired cuff pressure relative to the monitored peak pressure (**Ppeak**). The value you set is added to **Ppeak** to define the desired cuff pressure.

$$\text{Cuff pressure} = \text{Ppeak} + \text{Rel. pressure}$$

You also specify the maximum and minimum pressure limits, as described next.

Figure 12-7. System > IntelliCuff window, Auto mode

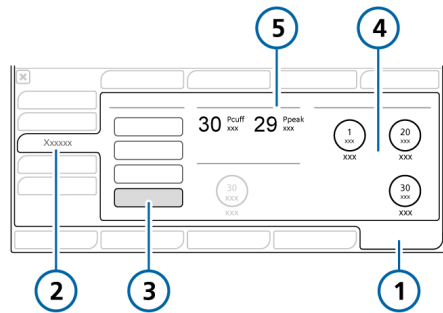

- | | |
|---------------|-------------------------------|
| 1 System | 4 Available pressure controls |
| 2 IntelliCuff | 5 Ppeak |
| 3 Auto | |

⁴⁸ Automatic control is available only from the ventilator IntelliCuff window; it is not available directly on the IntelliCuff device.

12.2.4 Setting the cuff pressure

The process for setting cuff pressure differs between Manual and Auto modes.

To set the cuff pressure from the ventilator in *Manual mode*

- ▶ In the System > IntelliCuff window, touch the **Cuff pressure** control, and set it to the desired value. See Figure 12-6.

IntelliCuff immediately starts adjusting the pressure to this setting, and maintains it at a constant level.

To set the cuff pressure from the ventilator in *Auto mode*

1. In the System > IntelliCuff window, touch the **Rel. pressure** control and set it to the desired value. See Figure 12-7.

The set value is added to the **Ppeak** setting, resulting in the delivered cuff pressure.

For example, by setting **Rel. Pressure** to 5 cmH₂O with a **Ppeak** setting of 20 cmH₂O, the maintained cuff pressure (**Pcuff**) is 25 cmH₂O.

2. Touch the **Min. pressure** and **Max. pressure** controls to set the minimum and maximum pressures to apply, respectively.

IntelliCuff immediately starts adjusting the pressure to these settings.

12.2.4.1 Cuff pressure during a recruitment maneuver

NOTICE

When performing a recruitment maneuver, cuff pressure is automatically set for the duration of the event.

During a recruitment maneuver, either using the P/V Tool or as part of INTELLIVENT-ASV auto-recruitment, cuff pressure is set as shown in Table 12-8.

Table 12-8. Cuff pressure during recruitment maneuver

Recruitment maneuver performed in...	Cuff pressure setting (set by device, nonadjustable)
P/V Tool	The highest of: <ul style="list-style-type: none"> • P_{top} + 5 cmH₂O⁴⁹ • Previous cuff pressure setting
INTELLIVENT-ASV auto-recruitment	The highest of: <ul style="list-style-type: none"> • Auto-recruitment pressure + 5 cmH₂O⁴⁹ • Previous cuff pressure setting

⁴⁹ The maximum allowed pressure is defined in IntelliCuff Configuration.

12.2.5 Deflating the cuff

Before turning off IntelliCuff or the ventilator, you must first deflate the cuff. Once it is deflated, you can turn off the device.

To deflate the cuff from the ventilator

1. In the System > IntelliCuff window, touch **Deflate** (Figure 12-5).
2. When prompted to confirm deflation, touch **Yes**.

The pressure in the cuff is released. When the cuff is fully deflated, the P_{cuff} value is 0.

To turn off IntelliCuff, see Section 12.2.2.

12.2.6 About IntelliCuff-related alarms

Active IntelliCuff-related alarms associated with the integrated cuff pressure controller are indicated in the following locations:

- Alarm message on the ventilator main display
- The **IntelliCuff** icon changes color (Table 12-7)

Figure 12-8. IntelliCuff-related alarm indicators on ventilator (showing medium-priority alarm)

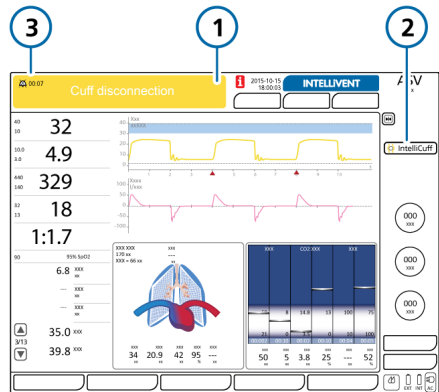

- | | |
|---------------------|-------------------------|
| 1 Alarm message bar | 3 Audio Pause indicator |
| 2 IntelliCuff icon | |

To silence an IntelliCuff alarm

- ▶ Touch the Audio Pause key on the ventilator (Figure 10-2).

Table 12-9 lists the IntelliCuff-related alarms shown on the ventilator.

Table 12-9. IntelliCuff alarms

Alarm text on ventilator	Description/Actions
Cuff leak <i>Low priority.</i>	The cuff loses pressure or is not properly connected. Actions <ul style="list-style-type: none"> • Check the cuff connections on the ventilator. • Check the cuff pressure tube, ET tubing, all cuff connections. • Change the ET tube, if needed. • Have the ventilator serviced to remove and replace IntelliCuff.
Cuff disconnection <i>Medium priority.</i>	The cuff loses pressure or is not properly connected. Actions <ul style="list-style-type: none"> • Check the cuff connections on the ventilator. • Check the cuff pressure tube, ET tubing, and all cuff connections. • Change the ET tube, if needed. • Have the ventilator serviced to remove and replace IntelliCuff.
Cuff high pressure <i>Medium priority.</i>	The pressure has been above the set cuff pressure for 2 or more seconds and cannot be reduced. Actions <ul style="list-style-type: none"> • Check the cuff connections on the ventilator. • Check the cuff pressure tube, ET tubing, and all cuff connections. • Change the ET tube, if needed. • Have the ventilator serviced to remove and replace IntelliCuff.
IntelliCuff not found <i>Low priority.</i>	The ventilator has not received a signal from IntelliCuff for more than 3 seconds. IntelliCuff continues to run and the cuff pressure is maintained, but the IntelliCuff window is not available. <i>Note that the IntelliCuff information in the ventilator System > Info 2 window is absent, and the IntelliCuff quick access icon is grayed out.</i> Actions <ul style="list-style-type: none"> • Manually maintain the cuff pressure as approved by your institution's protocol. • Have the ventilator serviced to remove and replace IntelliCuff.

12.2.7 About IntelliCuff-related parameters

The following control and monitoring parameters are used when IntelliCuff is operating.

Table 12-10. IntelliCuff-related parameters

Parameter	Description
IntelliCuff (CPC)	Shows the current software version. Displayed in the System > Info window.
Cuff pressure (cmH2O)	Control in Manual mode to set the cuff pressure.
Min. pressure (cmH2O)	Control in Auto mode to set the minimum cuff pressure.
Max. pressure (cmH2O)	Control in Auto mode to set the maximum cuff pressure.
Pcuff (cmH2O)	Monitored cuff pressure. Displayed in <ul style="list-style-type: none"> • IntelliCuff window • Monitoring > 2 window • Dynamic Lung panel • Main monitoring parameter (MMP), optional • Secondary monitoring parameter (SMP)
Ppeak (cmH2O)	Peak airway pressure. See Table 8-5.
Rel. pressure (cmH2O)	Control in Auto mode to set the relative pressure, that is, the pressure above Ppeak to achieve the desired cuff pressure.

12.2.8 Last Patient settings with IntelliCuff

When using the Last Patient selection, the previous IntelliCuff settings are used. In the System > IntelliCuff window, select the desired mode to turn on IntelliCuff and operate the device with the previous settings.

13

Maintenance

13.1	Overview.....	254
13.2	Cleaning, disinfection, and sterilization	254
13.3	Preventive maintenance	256
13.4	Performing maintenance tasks	258
13.5	Repacking and shipping	261

13.1 Overview

Before proceeding, review the safety information in Chapter 1.

You must comply with these maintenance procedures to ensure the safety and reliability of the ventilator. All the procedures in this manual are to be performed by the operator. For additional maintenance requirements, contact your Hamilton Medical service representative.

Documents referenced in this chapter are available on the MyHamilton website: <https://www.hamilton-medical.com/MyHamilton>

13.2 Cleaning, disinfection, and sterilization

The following sections provide general recommendations for cleaning, disinfecting, and sterilizing parts. For parts not supplied by Hamilton Medical, comply with the manufacturers' recommendations.

Do *not* attempt decontamination procedures unless specified by Hamilton Medical or the original manufacturer.

If you have any questions about the use of a particular cleaning or disinfection agent, contact the manufacturer of the agent.

After cleaning and decontaminating parts, perform any required tests and calibrations described in Chapter 5.

13.2.1 General guidelines for cleaning

Additional information for cleaning each part is included in Table 13-1.

To clean the device parts

1. Disassemble parts.
Note that breathing circuits must be disassembled completely and reprocessed as described in the associated *Reprocessing Guide*.
2. Wash parts in warm water and soap or an appropriate mild detergent solution.
3. Rinse parts thoroughly with clean, warm water.
4. Air dry.
5. Inspect all parts, and replace if damaged.
6. Sterilize or disinfect the parts, following the appropriate sterilization/disinfection procedure as described in the product documentation.
7. Reassemble and reinstall (if needed), and perform any required tests.

13.2.2 General guidelines for disinfection

Additional information for disinfecting each part is included in Table 13-1.

To disinfect the device parts

1. Clean, but do *not* re-assemble.
2. Disinfect with an appropriate mild bactericidal chemical solution.

Carefully follow the manufacturer's recommendations, including exposure time.

3. Reassemble and reinstall parts, and perform any required tests before reuse.

The following table summarizes the cleaning and disinfection guidelines for each major system component.

Table 13-1. Cleaning and disinfection methods parts

Part	Remarks	Cleaning method
Ventilator exterior including: <ul style="list-style-type: none"> • Housing • Tray • Gas supply hose • Power cables • Trolley • Mounting systems • Basket • Cylinder holding system (optional) 	<p><i>Do not</i> clean the ventilator interior. This can damage internal parts.</p> <p>! NOTICE! Pay very close attention to the exposure times listed by the cleaning agent manufacturer. Failure to follow manufacturers' recommendations can lead to incomplete cleaning and disinfection.</p> <p>Be particularly careful with infectious patients, and follow your hospital infection control procedures.</p>	<p>After each patient use, wipe with a damp cloth using a registered and approved surface cleaning/disinfection solution, as approved by your institution's protocol. Follow the cleaning agent manufacturer's recommendations.</p>
Touch screen	<ul style="list-style-type: none"> • Lock the screen before cleaning. See Section 10.2. • Handle the touch screen with care. • <i>Do not</i> use any vinegar-based solutions and avoid using a gritty cloth. 	<p>Wipe the screen with a damp, soft cloth using an appropriate and approved surface cleaning/disinfection solution or a nonabrasive glass cleaner.</p> <p>For approved cleaning agents, see Table 13-2.</p>

Part	Remarks	Cleaning method
Reusable accessories including: <ul style="list-style-type: none"> • Breathing circuits • Expiratory valves • Flow sensors • SpO2, CO2 sensors • Nebulizers • Masks • Filters and adapters • Water traps 	For CO2 sensors, refer to Hamilton Medical's <i>Approved cleaning agents for CO2 components statement</i> for supported cleaning and disinfectant agents.	Follow the instructions provided in the manufacturer's <i>Instructions for Use</i> and corresponding <i>Reprocessing Guide</i> .

Table 13-2. Cleaning agents for the touch screen

Cleaning agent	Concentration
Mikrobac Tissues wipes	n/a
mikrozid sensitive wipes	n/a
mikrozid AF liquid	Ready for use
Sani-Cloth Active wipes	n/a
Bacillol 30 Foam	Ready for use
Ethanol	--
Incidin Foam	Ready for use
Incidin Pro	0.25% to 4%
Incidin Rapid	0.25% to 2%
Isopropyl alcohol	--
Mikrobac forte	0.25% to 4%
perform	3%
terralin protect	2%

13.3 Preventive maintenance

Perform preventive maintenance on your ventilator according to the schedule shown in Table 13-3.

The System > Info window shows the number of hours the ventilator has been in operation.

Table 13-3. Preventive maintenance schedule

Interval	Part/accessory	Procedure
Between patients and according to hospital policy	Breathing circuit (including mask, inspiratory or expiratory filter, flow sensor, nebulizer jar, expiratory valve set)	Replace with sterilized or new single-patient use parts.
	Entire ventilator	Run the preoperational checks (Section 5.4).
Every day or as required	Gas inlet water trap	Empty any water by pressing the drain valve.
Every 2 days or according to hospital policy	Breathing circuit	Empty any water from breathing tubes or water traps. Inspect parts for damage. Replace as necessary.
Every month (or more often if required)	Fan filters (rear panel)	Check for dust and lint. If needed, clean or replace. See Section 13.4.1.
Every 3 months (1250 hours)	Batteries	Verify that batteries can hold their charge by unplugging the ventilator power cord and verifying that after 10 minutes the battery symbol (INT or EXT) is still green.
Yearly or as necessary	Galvanic O2 sensor	Replace if depleted. See Section 13.4.2.
	Air intake filter	Replace. See Section 13.4.1.
	Ventilator	Perform service-related preventive maintenance. ⁵⁰
	CO2 sensor	If the CO2 option is installed, have a CO2 accuracy check performed. ⁵⁰
Every 2 years, or as necessary	Internal (lead acid) and extended (lithium ion) batteries	Replace if indicated. ⁵⁰
Every 5 years	Monitor backlight	Replace if indicated. ⁵⁰
Yearly maintenance	IntelliCuff connection port ⁵¹	Perform service-related preventive maintenance. ⁵⁰

For the HAMILTON-H900 Humidifier, see the *HAMILTON-H900 Service Manual*.

⁵⁰ Must be performed by Hamilton Medical authorized service personnel according to instructions in the *Service Manual*.

⁵¹ The IntelliCuff device itself is maintenance free or should be maintained according to your institution's protocols. The port must be serviced annually.

13.4 Performing maintenance tasks

The following sections describe how to clean and replace filters, batteries, and a galvanic O2 sensor.

13.4.1 Maintaining the filters

Figure 13-1 summarizes the steps to exchange the air filter in the back of the ventilator.

To clean and reuse the filter, rinse in a mild soap solution, rinse with clean water, and dry before replacing it in the ventilator.

Figure 13-1. Removing and replacing the air filter

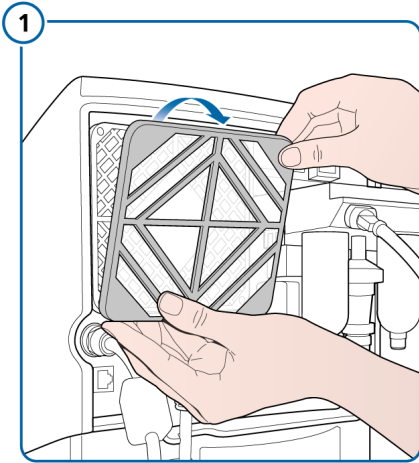

Remove filter cover.

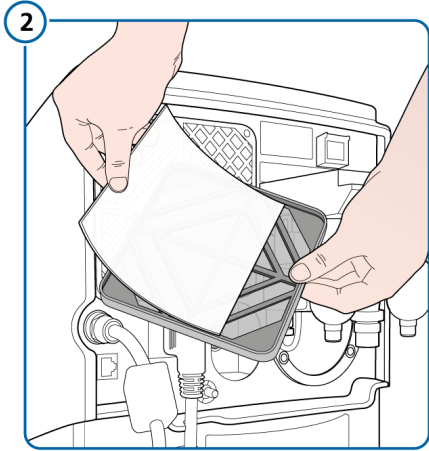

Remove air filter.

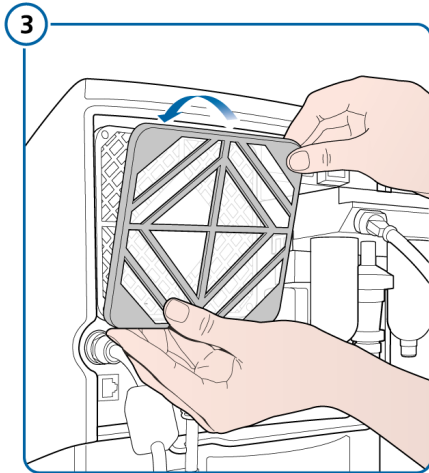

Replace filter and cover.

13.4.2 Replacing the galvanic O2 sensor

Before proceeding, review the safety information in Chapter 1.

Figure 13-2 summarizes the steps to remove a galvanic O2 sensor. To replace the cell, reverse the steps.

If using a paramagnetic O2 sensor, replacement is performed by certified service personnel.

Figure 13-2. Replacing the O2 sensor

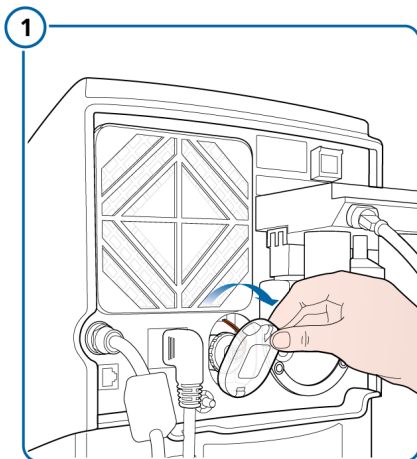

1 Remove O2 sensor cover.

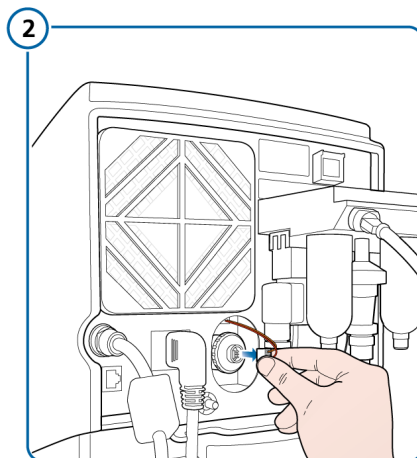

2 Unplug the O2 sensor cable.

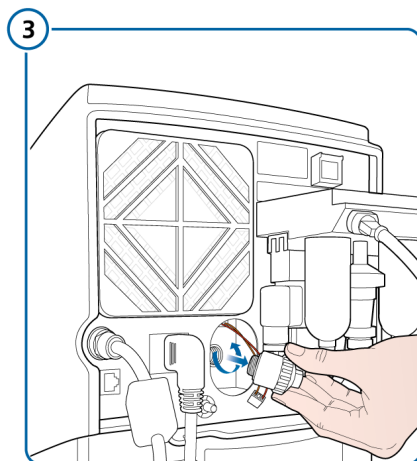

3 Turn O2 sensor counterclockwise to remove it.

13.4.3 Charging and storing batteries

To maintain the battery charge and to prolong the life of the battery, keep the ventilator connected to its primary power source.

Have the battery recharged every 3 months, depending on storage conditions. For details, see Section 16.4.

13.4.4 Replacing batteries

Figure 13-3 summarizes the steps to replace a battery.

Figure 13-3. Replacing the optional battery

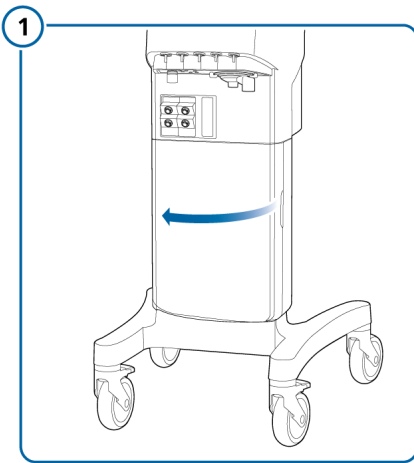

Open battery door.

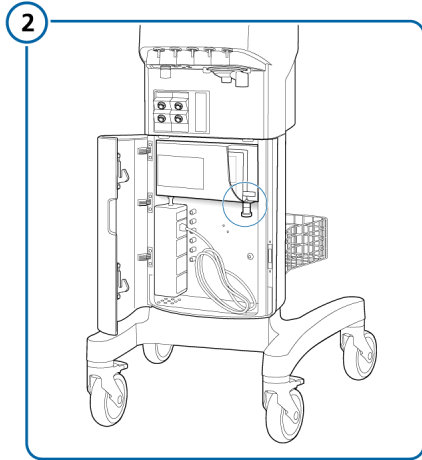

Locking bolt holds battery in place.

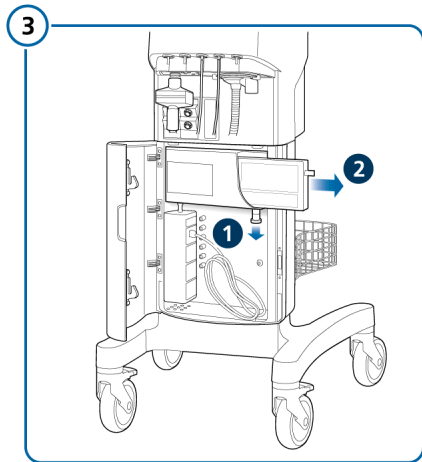

Pull down locking bolt (1), and slide battery out (2).

If used, slide in new battery and ensure locking bolt clicks into place.

13.5 Repacking and shipping

 **CAUTION**

Inform Hamilton Medical if you are shipping a contaminated (nonsterilized and nondisinfected) device for service.

If you must ship the ventilator, use the original packing materials. If these materials are not available, contact your Hamilton Medical representative for replacement materials.

14

Configuration

14.1	Overview.....	264
14.2	Accessing Configuration mode.....	264
14.3	Configuring general settings	264
14.4	Configuring MMPs.....	266
14.5	Configuring Vent Status settings.....	266
14.6	Configuring communication options	266
14.7	Configuring nebulization options	268
14.8	Activating IntelliCuff	268
14.9	Activating SpO2 and CO2 measurement	268
14.10	Defining system default settings.....	268
14.11	Configuring software and hardware options	270
14.12	Copying configuration settings.....	271



14.1 Overview

During configuration, you set up the ventilator with a default language, main monitoring parameter display, startup settings for a new patient, and units of measure, among other settings.

14.2 Accessing Configuration mode

You can access all Configuration mode settings when the ventilator is in Standby.

To access Configuration mode

1. Press the   keys at the same time.
The **Configuration** button appears at the bottom of the display.
2. Touch **Configuration**.
The Configuration window appears.

You can now define settings and add options.

14.3 Configuring general settings

You can configure some general default settings for the ventilator, including language, units of measure, communication interface to use, and minimum loudness for alarms.

14.3.1 Selecting the language

To select the user interface language

- ▶ Touch **Language** and select the desired language from the list.

14.3.2 Selecting the breath timing philosophy

The ventilator controls mandatory breath timing using a combination of inspiratory time (TI) and Rate.

For the modes (S)CMV, APVcmv, SIMV, and APVsimv, you can set the ventilator to use any of the following combinations to control breath timing: I:E/Pause, Ti/Pause, %Ti/Pause, or Peak Flow/Tip

To change the breath timing

- ▶ Touch **Customize** and select the desired breath timing option.

14.3.3 Selecting the units of measure

To select the units of measure

- ▶ Touch **Customize** and select the unit of measure for length and CO2 pressure.

14.3.4 Configuring adjustable alarms

You can control the display and activation status of the following alarms:

- Lower limit for Pressure
- Upper limit for ExpMinVol
- Upper and lower limits for Vt
- Upper and lower limits for Rate
- Upper limit for Oxygen
- Apnea time
- Leak
- Upper and lower limits for PetCO₂
- Upper and lower limits for Pulse rate
- Upper and lower limits for PI⁵²
- Upper and lower limits for PVI⁵²

To deactivate/activate alarm limits

1. Touch **Customize**.
2. Touch the button for each alarm limit to deactivate or activate.

Once saved, the deactivated alarm limits can no longer be set in the Alarms window and the associated visual and acoustic alarms are disabled.

14.3.5 Setting the minimum alarm loudness (volume)

You can specify a minimum alarm loudness (volume) setting for the ventilator. Once set, the ventilator operator cannot set the alarm volume below the value set here in Configuration.

To set the minimum alarm loudness

1. Touch **Customize**.
2. Touch the **Min. loudness** control and choose the minimum alarm volume to allow on the device. By default, it is set to 1.

The setting is applied to the ventilator. Note that if the new minimum is greater than the currently set alarm volume, the alarm volume is reset to the new minimum level.

To verify the setting, check the **Loudness** value in the Alarms > Loudness window.

14.3.6 Enabling the Check flow sensor for water alarm

Applicable for Neonatal patients only.

Under certain conditions, water may accumulate in the flow sensor, which can result in overstated volume measurements.

If the ventilator detects water in the flow sensor, the **Check flow sensor for water** alarm is generated. You can enable or disable this alarm, as desired, in Configuration.

To enable/disable the Check flow sensor for water alarm

1. Open the Configuration > Customize window.
2. Touch the **FS water alarm** checkbox to enable/disable the alarm.
A checkmark indicates the alarm is enabled.

⁵² If Masimo SET or rainbow SET option is installed.

14.4 Configuring MMPs

You can specify which MMPs to always display on the ventilator. The list of entries in the Configuration window is shown in the same order as the MMPs appear on the main display.

To select the MMPs to display

1. Touch **MMP selection**.
2. In each dropdown list, select the desired parameter to display in that position on the screen.

14.5 Configuring Vent Status settings

You can configure the weaning zone ranges according to your institution's protocol for the following parameters shown in the Vent Status panel (Section 8.4.2): Oxygen, PEEP, %MinVol, P_{insp}, RSB or P_{0.1}, and %Spont or VarilIndex.

For %MinVol, RSB, and VarilIndex, you specify the upper and lower limits of the target range.

To configure the weaning zone ranges

1. Touch **Vent Status**.
2. Select whether to display RSB or P_{0.1} and %Spont or VarilIndex.
3. For each parameter, set the desired upper limit and lower limit, when applicable.
4. Touch **Close** when done.

To reset the weaning zone ranges to the default values

- ▶ Touch **Vent Status**, then touch **Set factory defaults**.

For the default settings, see Table 16-10.

14.6 Configuring communication options

You can connect external devices to the ventilator using the communication interface. For a list of the communication protocols, see Table 2-2. For additional details, refer to the *Communications Interface User Guide*.

This section describes configuring the I:E timing outlet, accessing the communication protocols, and configuring a COM port for communication with a HAMILTON-H900 humidifier or distributed alarm system.

14.6.1 Configuring I:E timing

The I:E timing outlet signals the time for three breath cycle phases: Insufflation, Pause, Exhalation. These signals are used for special applications, such as an external nebulizer. In addition to the interface to use, you configure the I:E timing outlet by selecting the desired relay position (open, closed) for each of the phases.

For further setup and configuration details, see the *Communications Interface User Guide*, available on MyHamilton.

To configure the I:E timing outlet

1. In Configuration, touch the **Interface** button on the left.
2. For each phase, select the appropriate relay position, **Open** or **Closed**.
3. Touch **Close** to save your changes.

14.6.2 Selecting a communication protocol

You must activate both Configuration and Test mode to enable the communication interface controls. Note, however, that you do *not* actually use Test mode; it just needs to be enabled.

To select the communication protocol

1. Enter Configuration mode by simultaneously pressing the **O2 enrichment** and **Manual breath** keys.



The **Configuration** button appears at the bottom of the display.

2. Enable Test mode by simultaneously pressing the **Screen Lock/Unlock** and **Nebulizer On/Off** keys.



The **Test** button appears at the bottom of the display. You can ignore this button.

3. Touch the **Configuration** button.
4. In the Configuration window, touch **Interface**.
5. For the COM port you are using for communication with a desired device, select the appropriate protocol.
6. Touch **Close** to save your settings.

14.6.3 Configuring HAMILTON-H900 humidifier communication

To configure the RS-232 COM port for humidifier communication

- ▶ Follow the steps shown in Section 14.6.2, and select **Humidifier** as the protocol for the COM port to which you connect the humidifier.

14.6.4 Configuring distributed alarm system (DAS) communication

To configure the RS-232 COM port for communication with a DAS

- ▶ Follow the steps shown in Section 14.6.2, and select **HAMILTON-G5 / Block (ACK)** as the protocol for the COM port to which you connect the DAS.

14.7 Configuring nebulization options

Nebulization support comprises the following settings:

- For pneumatic nebulization, configure whether the ventilator compensates the gas volume provided by the nebulizer to ensure the set tidal volume is delivered
- Activate the Aerogen option, if appropriate (see Section 14.11.3)

To select the compensation method

1. Open the Configuration > Nebulizer window.
2. Touch **Internal** or **External**, as appropriate.
 - When set to **Internal** (default), the ventilator compensates for the extra gas volume delivered to the patient to ensure the set tidal volume is delivered.
 - When set to **External**, compensation is deactivated.
3. Touch **Close** to save your settings.

14.8 Activating IntelliCuff

To use the integrated IntelliCuff cuff pressure controller, you must activate the IntelliCuff hardware option. See Section 14.11.3.

14.9 Activating SpO2 and CO2 measurement

To enable SpO2 and/or CO2 measurement on the ventilator, you must activate the associated hardware option in Configuration. See Section 14.11.3

You must also enable each sensor in the System window. See Section 4.7.

14.10 Defining system default settings

System Defaults refers to a group of settings you define for each patient group, including patient characteristics, mode selection, SMPs, graphic layout, and control, alarm, nebulizer, and O2 enrichment settings.

Default settings are automatically applied when a patient group is selected in the Standby window.

You can also specify which patient group is selected by default when the ventilator is turned on.

To define default settings for each patient group

Configure the ventilator in Standby, using a test lung.

1. In the Standby window, select the patient group for which to specify settings: **Adult**, **Pediatric**, or **Neonatal**
2. Set the patient sex and height (Adult, Pediatric) or the patient weight (Neonatal).
3. Start ventilation using the test lung, and configure the ventilation settings:
 - a. In the Modes window, select the mode to use by default.

- b. In the Controls window, select the desired control settings according to your institution's protocol.
 - c. If needed, select **TRC** or **Sigh** in the Additions window.
 - d. Set the desired oxygen concentration to be delivered during O2 enrichment.
 - e. Set the desired nebulizer type, duration, and synchronization settings.
 - f. Select the desired graphics layout in the Graphics window, and configure the display with the desired graphic components.
 - g. Select the desired SMP view.
4. Enter Configuration mode.
 5. Touch **Defaults**.
 6. Touch **Set default** next to the patient group you just configured.
You are prompted to confirm the setting.
 7. Touch **Close**, then **Close/Save** to save your settings and exit Configuration.
 8. Repeat these steps for each patient group.

To set the default patient group

1. In Configuration, touch **Defaults**.
2. In the **Default Patient Group** section, touch the button to select the patient group to use by default.
3. Touch **Close** to save your changes.

To reset all ventilator settings to the original factory defaults

1. In Configuration, touch **Defaults**.
2. At the bottom right of the window, touch **Set factory defaults**.
Any configured default settings are deleted and the original factory settings are restored.

14.10.1 Exporting or importing default settings

Once the default settings for each patient group are configured on a device, you can export these settings and import them to other HAMILTON-S1 ventilators.

To export default settings

1. Insert a CF card into the card reader on the side of the monitor. See Figure 2-5.
2. In Configuration, touch **Defaults**.
3. At the bottom right of the window, touch **Export**.

The default settings for each patient group are exported to the USB drive.

To import default settings

1. Using a CF card with previously exported default settings, insert the CF card into the card reader on the side of the monitor. See Figure 2-5.
2. In Configuration, touch **Defaults**.
3. At the bottom right of the window, touch **Import**.

The default settings for each patient group are imported and saved as the new default settings on the ventilator.

14.10.2 Choosing the ASV version

By default, the device uses ASV version 1.1.

To select the ASV version

1. Touch **Defaults**.
2. Touch the **ASV 1.1** or **ASV** button.
3. Touch **Close** to save your changes.

14.10.3 Enabling the display of resistance- and compliance-related parameters

You can configure whether to display the **Rinsp**, **Rexp**, and **Cstat** monitored parameters. By default, the display of these parameters is turned off (shown as (---)).

To display the Rinsp, Rexp, and Cstat monitored values

1. In Configuration, touch **Defaults**.
2. Touch the **Display R & Cstat triggered breath** checkbox to enable the display of **Rinsp**, **Rexp**, and **Cstat**.
A checkmark indicates that the feature is enabled.

Rinsp, **Rexp**, and **Cstat** monitored parameter values are displayed in the Dynamic Lung, Monitoring window, and SMP views.

14.11 Configuring software and hardware options

Before use, you must enable any installed hardware options (for example, CO2, SpO2, Aerogen), and add and enable software options.

14.11.1 Reviewing installed options

To view installed options

- ▶ Touch **Options**.

The installed options are displayed in the **Software options** section of the window.

14.11.2 Adding software options

Software options are added using license keys.

Trial versions of software options may be available. Trial options expire and are automatically deactivated after 30 days.

Have all required keys available before proceeding.

To add a software option

1. Touch **Options**.
2. Using the keypad, type the activation code exactly as provided into the entry field and touch **Enter**.
If the message *Option key invalid* appears, re-enter the code.
3. Repeat until all desired software options are added.
4. Touch **Close**, and then **Close/Save** to save the changes and exit Configuration.
5. Restart the ventilator to enable the options.

Upon turning on the ventilator, the added options are available for use.

14.11.3 Activating hardware options

Hardware-related options must be activated in Configuration. These options include: IntelliCuff, Aerogen, HAMILTON-H900 humidifier, SpO2 measurement, CO2 measurement

- The hardware itself must be activated in configuration to make the functionality available to the user, described in this section.
- Sensors that plug into the hardware are individually enabled by the user, as needed, in the System window. See Chapter 4.

To activate hardware options in Configuration

1. Touch **Options**.
The window lists hardware that requires activation.
2. In the **Hardware options** section of the window, touch the options to activate.
When selected, the button is light blue.

Upon exiting Configuration, the activated hardware is available for use.

SpO2 and CO2 sensors require an additional step, and must also be enabled in the System window.

14.12 Copying configuration settings

Before proceeding, review the safety information in Chapter 1.

You can copy the configuration settings to a CompactFlash (CF) card and quickly transfer the settings to other HAMILTON-S1 devices.

If you remove the CF card before the files are successfully transferred, you must start over and repeat the export.

To copy configuration settings to a memory device

1. Insert a CF card into the card reader on the monitor. See Figure 2-2.
2. In Configuration, touch **Defaults**.
3. In the Defaults window, touch **Import** or **Export** to transfer configuration data to or from the card.

15

Parts and accessories

15.1	Overview.....	274
------	---------------	-----

15.1 Overview

This chapter lists the parts available for the HAMILTON-S1 ventilator. Note that not all parts are available in all markets.

For additional parts and accessories and ordering information, refer to the e-catalog on the Hamilton Medical website or contact your Hamilton Medical representative.

Figure 15-1. Ventilator parts and accessories

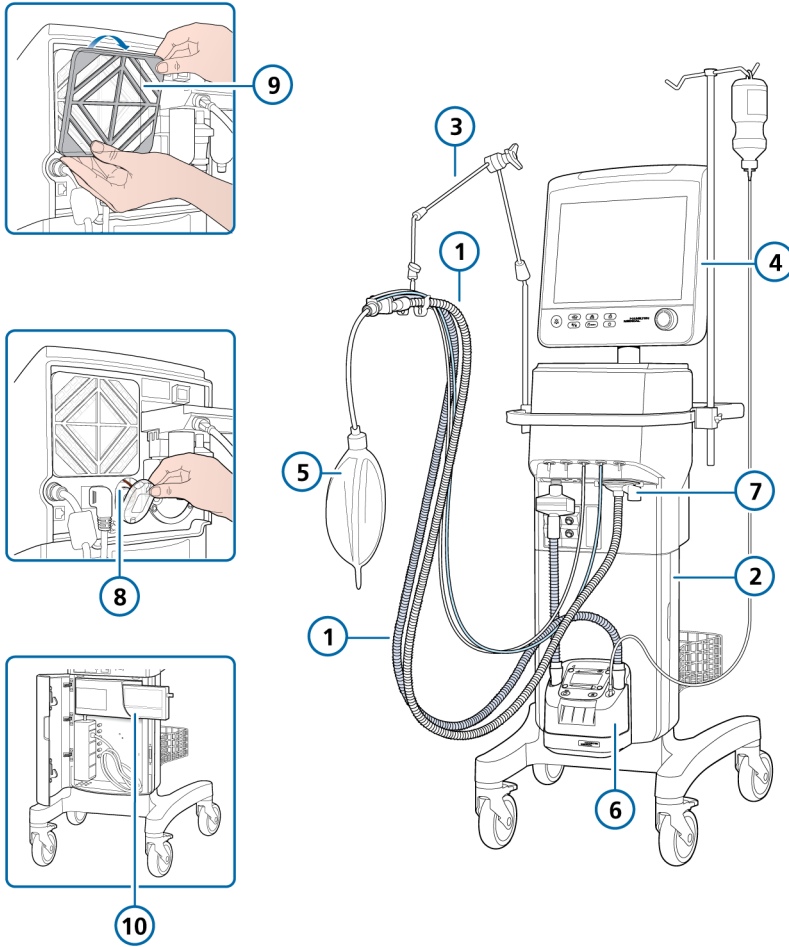

Table 15-1. Ventilator parts and accessories

Item no. (ref to Fig 15-1)	Description	PN
1	HAMILTON-H900 breathing circuit set, adult/pediatric	
	Breathing circuit set BC8022, dual limb, single use, preassembled, box of 15	260161
	Breathing circuit set BC8022-A, dual limb, preassembled, box of 1	260188
	Breathing circuit set BC4022, single limb, single use, preassembled, box of 15	260186
	HAMILTON-H900 breathing circuit set, neonatal	
	Breathing circuit set BC8010, dual limb, single use, preassembled, box of 15	260185
	Breathing circuit set BC8010-A, dual limb, autoclavable, preassembled, box of 1	260189
Breathing circuit set BC4010, single limb, single use, preassembled, box of 15	260187	
1	Breathing circuit set, coaxial, single use, adult/pediatric	
	Preassembled, length 1.80 m, box of 20	260206
	Preassembled with flow sensor, length 1.80 m, box of 20	260207
	Preassembled, length 2.40 m, box of 10	260239
	Preassembled, with flow sensor, length 2.40 m, box of 10	260240
Preassembled, with expandable expiratory limb, expiratory valve set and flow sensor, length 1.80 m, box of 20	260184	
1	Breathing circuit sets, dual limb, single use, neonatal	
	With Y-piece, flow sensor, flow sensor calibration adapter, and pressure line with T-piece connectors, length 1.80 m, box of 20	260180
	With Y-piece, flow sensor, flow sensor calibration adapter, and pressure line with T-piece connectors, length 3.0 m, box of 10	260182
	With expiratory valve set, Y-piece, flow sensor, flow sensor calibration adapter, and pressure line with T-piece connectors, length 1.50 m, box of 20	260170
With expiratory valve set, Y-piece, flow sensor, flow sensor calibration adapter, and pressure line with T-piece connectors, length 3.0 m, box of 10	260169	

Item no. (ref to Fig 15-1)	Description	PN
1	With Y-piece, length 1.50 m, box of 20	260241
	With Y-piece, length 3.0 m, box of 20	260244
1	Breathing circuit sets, autoclavable <i>See the online Hamilton Medical e-catalog.</i>	
1	Flow sensors, adult/pediatric	
	Flow sensor, single use, adult/pediatric, 1.88 m, box of 10	281637
	Flow sensor, single use, adult/pediatric, 1.88 m, box of 240	282092
	Flow sensor, single use, adult/pediatric, 2.60 m, box of 10	282049
	Flow sensor, autoclavable, adult/pediatric, 1.88 m, box of 1	950185
	Flow sensor calibration adapter, autoclavable, adult/pediatric, box of 10	282323
1	Flow sensors, neonatal	
	Flow sensor, single use, neonatal, 1.60 m, box of 10	260177
	Flow sensor, single use, neonatal, 1.88 m, box of 10	155500
	Flow sensor, single use, neonatal, 3.10 m, box of 10	260179
	Flow sensor calibration adapter, single use, neonatal, box of 10	279964
7	Expiratory valve	
	Expiratory valve set, autoclavable, box of 1	151972
	Membrane, expiratory valve, autoclavable, box of 5	151233
	Cover, expiratory valve, autoclavable, box of 1	151228
	Expiratory valve set, single use, box of 10	950158
	Expiratory valve set, single use, box of 50	282416
	Expiratory valve set, single use, box of 240	282417
<i>not shown</i>	Nasal cannula for high flow oxygen therapy (adult and adult/pediatric)	
	Size S, box of 10	282495
	Size M, box of 10	282496
	Size L, box of 10	282497

Item no. (ref to Fig 15-1)	Description	PN
<i>not shown</i>	NHF nasal prong for high flow oxygen therapy (adult and adult/pediatric)	
	Size 1, box of 10	282521
	Size 2, box of 10	282522
	Size 3, box of 10	282523
	Size 4, box of 10	282524
<i>not shown</i>	Nasal cannula adapter	
	Adapter, ID22/ID22, box of 30	282509
	Adapter, OD10/OD15, box of 30	282519
<i>not shown</i>	Masks and accessories, adult/pediatric	
	<i>See the Hamilton Medical e-catalog.</i>	
	NIV full face mask, single use, non-vented, size S	282507
	NIV full face mask, single use, non-vented, size M	282506
	NIV full face mask, single use, non-vented, size L	282505
<i>not shown</i>	Masks and accessories, neonatal	
	nCPAP-PS Starter kit, large (10 sets, incl. mask, prongs, and bonnets)	281975
	nCPAP-PS Starter kit, small (1 set, incl. mask, prongs, and bonnets)	282330
	Neonatal circuit adapter	160595
<i>not shown</i>	CO2 mainstream measurement	
	HAMILTON CAPNOSTAT-5 CO2 sensor	281718
	CO2 mainstream airway adapter, single use, adult/pediatric, box of 10	281719
	CO2 mainstream airway adapter, single use, neonatal, box of 10	281720
	CO2 mainstream airway adapter, reusable, adult/pediatric, box of 1	281721
	CO2 mainstream airway adapter, reusable, neonatal, box of 1	281722
	OD15/ID15 adapter, single use, neonatal, box of 25	281803

Item no. (ref to Fig 15-1)	Description	PN
<i>not shown</i>	CO2 sidestream measurement	
	HAMILTON LoFlo sidestream CO2 sensor	281928
	CO2 sidestream adapter, single use, adult/pediatric, box of 10	281929
	CO2 sidestream adapter, single use, adult/pediatric, box of 10	281931
	CO2 sidestream adapter, single use, neonatal/pediatric, box of 10	281930
	CO2 sidestream adapter, single use, neonatal, box of 10	281932
6	Humidifier	
	HAMILTON-H900 humidifier <i>See the Hamilton Medical e-catalog.</i>	
	Combination module, Aerogen nebulizer and HAMILTON-H900 humidifier connection module	159129
<i>not shown</i>	IntelliCuff	
	IntelliCuff cuff pressure controller <i>See the Hamilton Medical e-catalog.</i>	
2	Trolley	
	Standard trolley	159121
	Universal trolley	159120
	Basket for trolley	159145
	O2 cylinder holder (for universal trolley only)	159142
3	Support arm, quick-positioning	281533
	Support arm, quick-positioning, basic	281671
	Extension fork holder for quick-positioning support arm	281534
4	Water bottle holder (max. 1 kg per side)	281575
5	Demonstration lung	
	IntelliLung, maximum 1 liter	281869
	Demonstration lung assembly with endotracheal tube, adult, 2 liter, with OD15 connector	151815
	Demonstration lung assembly with endotracheal tube, 0.5 liter, with OD15/OD22 connector (pediatric)	151816

Item no. (ref to Fig 15-1)	Description	PN
5	Demonstration lung, neonatal, OD15 <i>A passive lung simulator with two independent compartments for simulating neonatal patients.</i>	R53353
9	Filter	
	Filter, fan	391163
<i>not shown</i>	Patient filter	
	HME filter (HMEF), single use, adult/pediatric	279963
	HME filter (HMEF), single use, adult/pediatric	279974
	Expiratory bacteria filter	279204
	Inspiratory bacteria filter	279211
<i>not shown</i>	Power cord	
	Power cord with US plug, 2.5 m	355190
	Power cord with British angled plug, 2.5 m	355191
	Power cord with continental European plug, 2.5 m	355192
	Power cord with Swiss plug, 2.5 m	355181
8	Oxygen sensor	
	Galvanic O2 sensor	396008
	O2 sensor, Teledyne	396009
	Paramagnetic O2 sensor kit	159715
<i>not shown</i>	Communication	
	Cable, RS-232 serial connector to computer, 2.5 m (8.2 ft) <i>Shielded on male (ventilator) side only</i>	157354
<i>not shown</i>	VENTILAIR II medical air compressor and accessories	
	VENTILAIR II compressor unit, 220 to 240 V, 50/60 Hz ⁵³	155600
	VENTILAIR II compressor unit, 100 to 115 V, 50/60 Hz	155601
	VENTILAIR II mounting kit	159146
	VENTILAIR II trolley extension	159147

⁵³ Not available in all markets, including the USA.

Item no. (ref to Fig 15-1)	Description	PN
10	Battery	
	Extended battery pack	369102
<i>not shown</i>	Oxygen connector	
	Oxygen supply hose, white, 4 m	281431
	Air supply hose, black/white, 4 m	281432
<i>not shown</i>	SpO2 sensors and accessories (Masimo) <i>See the Hamilton Medical e-catalog.</i>	
	SpO2 sensors and accessories (Nihon Kohden) <i>See the Hamilton Medical e-catalog.</i>	
<i>not shown</i>	Nebulizer and accessories <i>See the Hamilton Medical e-catalog.</i>	
<i>not shown</i>	Tools and test equipment <i>See the Hamilton Medical e-catalog.</i>	
	Language kit	
	English	159167
	German	159169
	French	159195
	Spanish	159196
	Japanese	159197
	Chinese	159198
	Russian	159642
Portuguese	159643	

16

Specifications

16.1	Physical characteristics.....	282
16.2	Environmental requirements.....	283
16.3	Pneumatic specifications	284
16.4	Electrical specifications	285
16.5	Control settings	287
16.6	Monitored parameters	292
16.7	Alarms	299
16.8	Configuration	301
16.9	ASV technical data	304
16.10	Ventilator breathing system specifications	306
16.11	Technical performance data	307
16.12	Functional description of ventilator system	312
16.13	Symbols used on device labels and packaging	316
16.14	Standards and approvals	318
16.15	Disposal and year of manufacture	319
16.16	Warranty.....	320

16.1 Physical characteristics

Table 16-1. Physical characteristics

Dimension	Specifications
Weight	<p>With standard trolley: 57 kg (125.6 lb)</p> <p>With shelf mount: 38 kg (83.8 lb)</p> <p>The standard trolley can accommodate a maximum safe working load of 80 kg (176 lb).⁵⁴</p> <p>The universal trolley can accommodate a maximum safe working load of 140 kg (308 lb).⁵⁴</p>
Dimensions	See Figure 16-1.

Figure 16-1. HAMILTON-S1 dimensions (shown with the standard trolley)

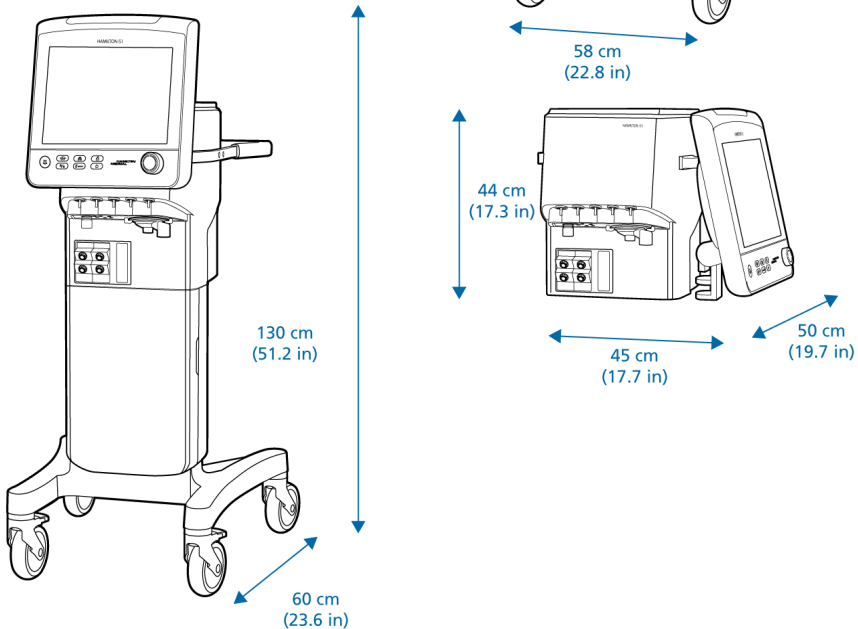

⁵⁴ The maximum safe working load applies to a stationary, properly load-balanced trolley.

16.2 Environmental requirements

Table 16-2. Environmental requirements

Environment		Specifications
Temperature	Operation:	10°C to 40°C (50°F to 104°F)
	Storage:	-10°C to 60°C (14°F to 140°F), in original packaging
Altitude		-650 to 3000 m (-2,132 to 9843 ft) Note that at higher altitudes the ventilator performance may be limited. The Performance limited by high altitude alarm is generated and a message is shown on the display. See Table 9-2.
Atmospheric pressure	Operation and storage:	700 to 1100 hPa
Relative humidity	Operation:	30% to 75%, noncondensing
	Storage:	5% to 85%, noncondensing
Water protection		IP21

16.3 Pneumatic specifications

Table 16-3. Pneumatic specifications

Component	Specifications	
Oxygen and air inlet	Pressure:	<ul style="list-style-type: none"> • Oxygen: 2 to 6 bar / 29 to 87 psi • Air: 2 to 6 bar / 29 to 87 psi
	Flow:	<ul style="list-style-type: none"> • Maximum: 120 l/min • Minimum: 40 l/min
	Connector:	<ul style="list-style-type: none"> • DISS (standard) <ul style="list-style-type: none"> – Oxygen: CGA 1240 – Air: CGA 1160-A – Heliox: CGA 1180-A (optional) • NIST (optional) • NF (optional)
Oxygen, air, and heliox inlet	Pressure:	<ul style="list-style-type: none"> • Oxygen: 2 to 6 bar / 29 to 87 psi • Air: 2.8 to 6 bar / 41 to 87 psi • Heliox: 2.8 to 6 bar / 41 to 87 psi
	Flow:	<ul style="list-style-type: none"> • Maximum: 120 l/min • Minimum: 40 l/min
Gas mixing system	Delivered flow:	<ul style="list-style-type: none"> • Maximum: 180 l/min peak flow • Maximum: 120 l/min continuous flow
	Delivered pressure:	0 to 120 cmH2O
	Flow accuracy:	±10% or ±300 ml/min (whichever is greater)
Inspiratory outlet (To patient port)	Connector:	ISO ID15/OD22 conical
Expiratory outlet (From patient port)	Connector (on expiratory valve):	ISO ID15/OD22 conical
	Exhaust port	OD30
IntelliCuff port	Dedicated connection port for IntelliCuff. For details, see the <i>IntelliCuff Instructions for use</i> .	

16.4 Electrical specifications

Table 16-4. Electrical specifications

Element	Specifications
Input power	100 to 240 VAC \pm 10%, 50/60 Hz 2.7 A maximum (at 100 V), 1.2 A maximum (at 240 V)
Main fuses	T 5.0 AH, 250 V
Internal battery	Hamilton Medical provides a sealed lead-acid internal battery. An optional lithium-ion extended battery pack is available.
Electrical specifications:	12 V DC, 15 Ah
Type:	Lead-acid, supplied by Hamilton Medical only
Normal operating time:	Typically 1 hour. Operating time is measured with one fully charged battery, the nebulizer and communications interface option enabled, and with these settings: (S)CMV, Rate = 15 b/min, Vt = 500 ml, I:E = 1:2, PEEP = 5 cmH ₂ O, Flow trigger = 5 l/min, FiO ₂ = 50%, display brightness = 30%. This operating time applies to new, fully charged batteries that have not been exposed to extreme temperatures. The actual operating time depends on battery age and on how the battery is used and recharged. To ensure maximum battery life, maintain a full charge and minimize the number of complete discharges.
Recharge time:	Allow a minimum of 15 hours to fully charge the internal battery.
Storage:	-20°C to 40°C, \leq 85% relative humidity. The storage location should be free from vibration, dust, direct sunlight, moisture, and corrosive gases, and with a recommended temperature range < 30°C. Extended exposure to temperatures above 45°C can degrade battery performance and life.

Element	Specifications
Extended battery pack	<p>Electrical specifications: 14.4 V DC, 6.6 Ah</p>
	<p>Type: Lithium-ion, supplied by Hamilton Medical only</p>
	<p>Normal operating time: Typically 1 hour.</p> <p>Operating time is measured with one fully charged battery, the nebulizer and communications interface option enabled, and with these settings: (S)CMV, Rate = 15 b/min, Vt = 500 ml, I:E = 1:2, PEEP = 5 cmH2O, Flow trigger = 5 l/min, FIO2 = 50%, display brightness = 30%.</p> <p>This operating time applies to new, fully charged batteries that have not been exposed to extreme temperatures. The actual operating time depends on battery age and on how the battery is used and recharged. To ensure maximum battery life, maintain a full charge and minimize the number of complete discharges.</p>
	<p>Recharge time: Allow a minimum of 7 hours to fully charge the extended battery pack, and 3 hours with an external charger while the ventilator is connected to AC power.</p>
	<p>Storage: -20°C to 40°C, ≤ 85% relative humidity. The storage location should be free from vibration, dust, direct sunlight, moisture, and corrosive gases, and with a recommended temperature range < 30°C.</p> <p>Extended exposure to temperatures above 45°C can degrade battery performance and life.</p>

16.5 Control settings

Table 16-5 provides the control parameter ranges, default settings, and accuracy of measurements.

For details about HAMILTON-H900 humidifier control settings, see the *HAMILTON-H900 Instructions for use*.

For details about IntelliCuff control settings, see the *IntelliCuff Instructions for use*.

All control settings can be set without any loss in accuracy. Measured parameters are subject to sensor accuracy as stated in Table 16-6.

Table 16-5. Control settings, ranges, and accuracy

Parameter or setting (unit)	Range:	Range:	Default:	Default:
	Adult/Pediatric	Neonatal	Adult/Pediatric	Neonatal
%MinVo] ⁵⁵ (%)	25 to 350	--	100	--
%TI (%)	<i>Adult</i> : 4 to 80	--	33	--
Additional O2 for enrichment ⁵⁶ (%)	0 to 79	0 to 79	79	10
Backup	Enabled, disabled	Enabled, disabled	Enabled	Enabled
End PEEP (cmH2O)	0 to 35 ⁵⁷	0 to 20 ⁵⁷	startup setting = PEEP	startup setting = PEEP
ETS ^{58, 59} (%)	5 to 70	5 to 70	25	25
Flow ⁶⁰ (l/min)	1 to 60	1 to 12	15	1
FlowPattern ⁶¹	Square, 50% decelerating, Sine, 100% decelerating	--	50% decelerating	--
Gender (sex)	Male, Female	n/a	Male	--

⁵⁵ Only in ASV mode.

⁵⁶ Not available in all markets.

⁵⁷ In some markets, the maximum is 20 cmH2O.

⁵⁸ Expiratory trigger sensitivity, in % of inspiratory peak flow.

⁵⁹ When selecting a noninvasive mode, the device uses the ETS value used in the previous mode, if available. If the previous mode did not use ETS, the device sets ETS to default values.

⁶⁰ Only for Hi Flow O2 therapy.

⁶¹ Parameter depends on selected ventilation timing philosophy, set in Configuration.

Parameter or setting (unit)	Range:	Range:	Default:	Default:
	Adult/Pediatric	Neonatal	Adult/Pediatric	Neonatal
I:E ⁶²	1:9 to 4:1	--	1:2.0	--
Nebulizer Duration (min)	5 to 40	30	5 to 40	30
Nebulizer Synchronization	Inspiration, Exhalation, Insp. and Exh.	Inspiration	Inspiration, Exhalation, Insp. and Exh.	Inspiration
Oxygen (%)	21 to 100	21 to 100	50	40
P ASV limit ⁵⁵ (cmH ₂ O)	10 to 110	--	30	--
P high (cmH ₂ O)	0 to 50	0 to 50	20	20
P low (cmH ₂ O)	0 to 50	0 to 25	5	5
Patient height (cm)	<i>Adult:</i> 130 to 250 <i>Pediatric:</i> 30 to 150	--	<i>Adult:</i> 176 <i>Pediatric:</i> 100	--
Patient height (in)	<i>Adult:</i> 50 to 100 <i>Pediatric:</i> 12 to 60	--	<i>Adult:</i> 69 <i>Pediatric:</i> 39	--
Pause ⁶³ (%)	0 to 70	--	0	--
Pcontrol ⁶⁴ (cmH ₂ O)	5 to 100	3 to 50	15	15
Peak flow ⁶⁵ (l/min)	<i>Adult only:</i> 1 to 180	--	<i>Adult only:</i> 54	--
PEEP/CPAP (cmH ₂ O)	0 to 50	0 to 50	5	5

⁶² In PCV+, (S)CMV, SIMV, and APVcmv modes, mandatory breath timing can be controlled by using a combination of inspiratory time (TI) and rate, or by the I:E ratio; set the method in Configuration. All other modes are controlled by using a combination of inspiratory time (TI) and rate.

⁶³ Limited to 25% of TI.

⁶⁴ Control pressure, added to PEEP/CPAP.

⁶⁵ Limitation changes based on flow pattern and Vt.

Parameter or setting (unit)	Range:	Range:	Default:	Default:
	Adult/Pediatric	Neonatal	Adult/Pediatric	Neonatal
P-ramp ⁶⁶ (ms)	0 to 200 ⁶⁷	0 to 200	<i>Adult:</i> 50 <i>Pediatric:</i> 100	100
Pstart (cmH ₂ O)	0 to 20 ⁵⁷	0 to 20 ⁵⁷	startup setting = PEEP	startup setting = PEEP
Psupport ⁶⁸ (cmH ₂ O)	0 to 100	0 to 50	15	15
Ptop (cmH ₂ O)	25 to 60	25 to 60	35	35
Ramp speed (cmH ₂ O/s)	2 to 5	2 to 5	3	3
Rate ⁶⁹ (b/min)	<i>APVcmv, (S)CMV, P-CMV:</i> 5 to 120 <i>APVsimv, SIMV, P-SIMV, DuoPAP:</i> 1 to 60	<i>APVcmv, nCPAP-PS, P-CMV:</i> 5 to 150 <i>APVsimv, P-SIMV, DuoPAP:</i> 1 to 80	<i>Adult:</i> 15 <i>Pediatric:</i> 25	30
Sigh ⁷⁰	Enabled, disabled	Enabled, disabled	Disabled	Disabled
T high (s)	0.10 to 30.00	0.10 to 30.00	<i>Adult:</i> 1.3 <i>Pediatric:</i> 0.8	0.6
T low (s)	0.10 to 30.00	0.10 to 30.00	<i>Adult:</i> 0.5 <i>Pediatric:</i> 0.3	0.2
Tl max ⁷¹ (s)	0.5 to 3.0	0.25 to 3.0	<i>Adult:</i> 2.0 <i>Pediatric:</i> 1.5	1.0
Tl ^{62, 72} (s)	<i>Adult:</i> 0.10 to 9.60 <i>Pediatric:</i> 0.10 to 3.00	0.10 to 3.00	<i>Adult:</i> 1.3 <i>Pediatric:</i> 0.8	0.6

⁶⁶ P-ramp is limited to one-third (1/3) of Tl time. Adjustment of Tl time can override the P-ramp setting. Limitation in ASV, SPONT, NIV, NIV-ST, nCPAP-PS: max 200 ms.

⁶⁷ In some markets, P-ramp cannot be set below 25 ms.

⁶⁸ Pressure support, added to PEEP/CPAP.

⁶⁹ Startup setting derived from IBW (adult/pediatric), body weight setting (neonatal). Does not apply in ASV mode.

⁷⁰ Sigh is disabled in DuoPAP, APRV, Hi Flow O₂, and for neonates.

⁷¹ Maximum inspiratory time for spontaneous breaths during noninvasive ventilation.

⁷² Inspiratory time; used with Rate to set the breath cycle time.

Parameter or setting (unit)	Range:	Range:	Default:	Default:
	Adult/Pediatric	Neonatal	Adult/Pediatric	Neonatal
Tip ⁷³ (s)	<i>Adult only:</i> 0 to 8	--	<i>Adult only:</i> 0	--
Tpause (s)	0 to 30	0 to 30	0	0
TRC Compensate ⁷⁴ (%)	10 to 100	10 to 100	80	80
TRC Tube size (I.D.) (mm)	<i>Adult:</i> 5 to 10 <i>Pediatric:</i> 3 to 7	2.5 to 5	<i>Adult:</i> 7 <i>Pediatric:</i> 4	3.5
TRC Tube type	ET tube, Trach tube, Disable TRC	ET tube, Trach tube, Disable TRC	Disable TRC	Disable TRC
Trigger, Expiratory	ETS, IntelliSync+ ⁵⁶	ETS	ETS	ETS
Trigger, flow ⁷⁵ (l/min)	0.5 to 15	0.1 to 5.0	<i>Adult:</i> 5 <i>Pediatric:</i> 3	1.5
Trigger, Inspiratory	P-trigger, Flowtrigger, IntelliSync+ ⁵⁶ , Trigger off	P-trigger, Flow trigger, Trigger off	Flow trigger	Flow trigger
Trigger, pressure (P-trigger) (cmH ₂ O)	-0.5 to -15.0 (below PEEP/CPAP)	-0.1 to -5.0 (below PEEP/CPAP)	-2.0	-1.0
V limit (ml)	--	4 to 400	--	150% of Vtarget
Vt (ml)	<i>Adult:</i> 100 to 2000 <i>Pediatric:</i> 20 to 300	--	<i>Adult:</i> 500 <i>Pediatric:</i> 100	--

⁷³ Applicable only when the *Peak flow - Tip* breath timing option is selected.

⁷⁴ Set to 0% to have Ptrachea displayed without compensation.

⁷⁵ Flow trigger is leak compensated.

Parameter or setting (unit)	Range:	Range:	Default:	Default:
	Adult/Pediatric	Neonatal	Adult/Pediatric	Neonatal
V _{target} (ml)	<i>Adult:</i> 100 to 2000 <i>Pediatric:</i> 20 to 300	2 to 200	<i>Adult:</i> 500 <i>Pediatric:</i> 100	20
Weight ⁷⁶ (kg)	--	0.2 to 15.0	--	3.0

⁷⁶ Set in configuration. IBW is calculated using height and sex, and is used for adult and pediatric patients. Actual body weight is used for neonates.

16.6 Monitored parameters

Table 16-6 provides the monitored parameter ranges, default settings, and accuracy of measurements.

Tables 16-7 and 16-8 list the ranges of the real-time curves and loops. Pressure, flow, and volume measurements are based on readings from the flow sensor, and are expressed in BTPS (body temperature and pressure saturated).

Table 16-6. Monitored parameters, ranges, and accuracy

Parameter (units)	Range	Accuracy ⁷⁷
Pressure		
AutoPEEP (cmH ₂ O)	0 to 99	± 5% or ± 1 cmH ₂ O, whichever is greater
Driving pressure, ΔP (cmH ₂ O)	0 to 99	± 5% or ± 1 cmH ₂ O, whichever is greater
Paux ⁷⁸ (cmH ₂ O)	-250 to 250	± 5% or ± 1 cmH ₂ O, whichever is greater
PEEP/CPAP (cmH ₂ O)	0 to 99	± 5% or ± 1 cmH ₂ O, whichever is greater
Pmean (cmH ₂ O)	0 to 99	± 5% or ± 1 cmH ₂ O, whichever is greater
Ppeak (cmH ₂ O)	0 to 120	± 5% or ± 1 cmH ₂ O, whichever is greater
Pplateau (cmH ₂ O)	0 to 99	± 5% or ± 1 cmH ₂ O, whichever is greater
Pminimum (cmH ₂ O)	-99 to 99	± 5% or ± 1 cmH ₂ O, whichever is greater
Ptrans I (cmH ₂ O)	-99 to 99	± 5% or ± 1 cmH ₂ O, whichever is greater
Ptrans E (cmH ₂ O)	-99 to 99	± 5% or ± 1 cmH ₂ O, whichever is greater

⁷⁷ The stated accuracy includes the tolerance interval for each measurement, except for measurements displayed from external sensors (CO₂). See Section 16.11.1 for details.

⁷⁸ Only for Hi Flow O₂ therapy.

Parameter (units)	Range	Accuracy ⁷⁷
Flow		
Insp Flow (l/min)	0 to 999	±10% or ±1 l/min, whichever is greater
Exp Flow (l/min)	0 to 999	±10% or ±1 l/min, whichever is greater
Flow (l/min) ⁷⁸	0 to 999	--
Volume		
ExpMinVol ⁷⁹ (l/min)	0 to 99.9	±10% or ±1 ml * fTotal, whichever is greater
MinVol NIV ⁸⁰ (l/min)	0 to 99.9	--
MVSpont ⁷⁹ MVSpO NIV ⁸⁰ (l/min)	0 to 99.9	±10% or ±1 ml * fTotal, whichever is greater
VTE ⁷⁹ (ml)	0 to 9999	±10% or ±2 ml, whichever is greater
VLeak (ml)	0 to 9999	±10% or ±1 ml, whichever is greater
VTE NIV ⁸⁰ (ml)	0 to 9000	--
VTSpont (ml)	0 to 9999	±10% or ±2 ml, whichever is greater
VTI (ml)	0 to 9999	±10% or ±2 ml, whichever is greater
Vt/IBW (ml/kg)	<i>Adult/Pediatric only</i> 0 to 99	--
Vt/Wt (ml/kg)	<i>Neonatal only</i> 0 to 99	--
VLeak (%)	0 to 100	--

⁷⁹ Only for invasive modes.⁸⁰ NIV is used with noninvasive modes.

Parameter (units)	Range	Accuracy ⁷⁷
MVLeak (l/min)	0 to 99.9	--
Time		
I:E	1:99 to 99:1	--
fSpont (b/min)	0 to 999	±2 b/min
fTotal (b/min)	0 to 999	±2 b/min
TI (s)	0.0 to 99.9	±100 ms
TE (s)	0.0 to 99.9	±100 ms
Other calculated and displayed parameters		
Cstat (ml/cmH ₂ O)	0 to 200	--
Oxygen (%)	18 to 100	± (volume fraction of 2.5% + 2.5% of gas level)
P0.1 (cmH ₂ O)	-99 to 0	--
PTP (cmH ₂ O * s)	0 to 99	--
RCexp ⁸¹ (s)	0.0 to 99.9	--
RCinsp (s)	0.0 to 99.9	--
Rexp (cmH ₂ O/l/s)	0 to 999	--
Rinsp (cmH ₂ O/l/s)	0 to 999	--
RSB (1 / (l*min))	0 to 999	--

⁸¹ Least square fit method.

Parameter (units)	Range	Accuracy ⁷⁷
SpO2/FiO2	0 to 500	--
VarIndex (%)	0 to 50	--
WOBimp (J/l)	0.00 to 9.99	--
CO2 related⁸²		
FetCO2 (%)	0 to 19.7	CO2 (BTPS): 0 to 40 mmHg: ±2 mmHg 41 to 70 mmHg: ±5% of reading 71 to 100 mmHg: ±8% of reading 101 to 150 mmHg: ±10% of reading For sidestream CO2 sensor above 80 b/min: ±12% of reading
PetCO2 (mmHg)	0 to 150	
slopeCO2 ⁸³ (%CO2/l)	0 to 9.99	±5% CO2/l
Vtalv ⁸³ (ml)	0 to 9999	±20% or ±20 ml, whichever is greater
V'alv ⁸³ (l/min)	0 to 20	--
V'CO2 ⁸³ (ml/min)	0 to 9999	±20% or ±30 ml/min, whichever is greater
VDaw ⁸³ (ml)	0 to 999	±20% or ±20 ml, whichever is greater
VDaw/VTE ⁸³ (%)	0 to 100	--
VeCO2 ⁸³ (ml)	0 to 999	±20% or ±2 ml, whichever is greater
ViCO2 ⁸³ (ml)	0 to 999	±20% or ±2 ml, whichever is greater

⁸² Only available if the CO2 communication board is installed and the CO2 sensor is enabled.

⁸³ Only for mainstream CO2.

Parameter (units)	Range	Accuracy ⁷⁷
P/V Tool Pro related		
Pressure at cursors (cmH ₂ O)	0 to 99	--
Volume at cursors (ml)	0 to 9999	--
Volume difference at cursors (ml)	0 to 9999	--
Flow at cursors (l/min)	-300 to 300	--
Compliance at cursors (ml/cmH ₂ O)	0 to 999	--
P _{top} (cmH ₂ O)	0 to 99	--
T _{maneuver} (s)	0 to 99	--
Lower inflection point (cmH ₂ O)	0 to 99	--
Upper inflection point (cmH ₂ O)	0 to 99	--
Point of derecruitment (cmH ₂ O)	0 to 99	--
V _{peep} (ml)	0 to 9999	--
Humidifier related		
T humidifier (°C)	0 to 99.9	--
IntelliCuff related		
P _{cuff} (cmH ₂ O)	-250 to 250	±10% or ±1 cmH ₂ O, whichever is greater

⁸⁴ Scaled automatically. Not leak compensated.

⁸⁵ Available with CO₂ option.

Table 16-7. Real-time waveforms

Parameter	Range	Y-axis scale
<i>All waveforms show time on the x-axis. The following options are available: Auto, 5, 10, 20, 30, and 60.</i>		
Volume ⁸⁴ (V) (ml) / time (s)	-200 to 3200	Auto (<i>default</i>), 0 to 5, 0 to 10, 0 to 25, 0 to 50, 0 to 100, 0 to 200, 0 to 400, 0 to 800, 0 to 1600, 0 to 3200
Flow ⁸⁴ (l/min) / time (s)	-200 to 200	Auto (<i>default</i>), 0 to 2.5, 0 to 5, 0 to 10, 0 to 25, 0 to 50, 0 to 100, 0 to 200
Airway pressure (Paw) (cmH ₂ O) / time (s)	-120 to 120	Auto (<i>default</i>), 0 to 10, 0 to 20, 0 to 40, 0 to 60, 0 to 80, 0 to 120
Auxiliary pressure (Paux) (cmH ₂ O) / time (s)	-120 to 120	Auto (<i>default</i>), 0 to 10, 0 to 20, 0 to 40, 0 to 60, 0 to 80, 0 to 120
FetCO ₂ ⁸⁵ (%) / time (s)	0 to 10	Auto
PetCO ₂ ⁸⁵ (mmHg) / time (s)	0 to 100	Auto

Table 16-8. Real-time graphics and loops

Parameter	X-axis scale	Y-axis scale
ASV graphs		
ASV target graphics: Vt/Rate x-axis: b/min y-axis: ml	0 to 60	0 to 5, 0 to 10, 0 to 25, 0 to 50, 0 to 100, 0 to 200, 0 to 400, 0 to 800 (<i>default</i>), 0 to 1600, 0 to 3200
Loops		
Pressure/Volume x-axis: cmH2O y-axis: ml	-120 to 120	-200 to 3200
Volume/Flow x-axis: ml y-axis: l/min	-200 to 3200	-200 to 200
Pressure/Flow x-axis: cmH2O y-axis: l/min	-120 to 120	-200 to 200
Volume/PCO2 ⁸⁶ x-axis: ml y-axis: mmHg	-200 to 3200	0 to 100

⁸⁶ Available with CO2 option.

16.7 Alarms

For additional details about alarms, see Chapters 5 and 9.

Table 16-9 provides details about the adjustable alarms, including priority, upper and lower limit range, and default settings.

Table 16-9. Adjustable alarm priority, range, defaults, and resolution

Alarm (units)	Priority	Range:	Range:	Default:	Default:	Resolution
		Adult/Ped	Neo	Adult/Ped	Neo	
Apnea time (s)	High	15 to 60	5 to 30 <i>nCPAP-PS</i> : 5 to 30/Off	20	5	5
ExpMinVol, high (l/min)	High	<i>Adult</i> : 2.0 to 50.0/Off <i>Pediatric</i> : 0.3 to 10/Off	0.03 to 10.0/Off	<i>Adult</i> : 10 <i>Pediatric</i> : 3.5	2	<i>Adult</i> : 1 <i>Pediatric</i> : 0.1 <i>Neonatal</i> : 0.01 (< 1) 0.1 (≥ 1)
ExpMinVol, low (l/min)	High	<i>Adult</i> : Off/0.1 to 49.0 <i>Pediatric</i> : Off/0.1 to 9.8	Off/0.01 to 9.8	<i>Adult</i> : 4 <i>Pediatric</i> : 1.5	0.5	<i>Adult</i> : 0.1 (≥ 1) 1 (≥ 1) <i>Pediatric</i> : 0.1 <i>Neonatal</i> : 0.01 (< 1) 0.1 (≥ 1)
Leak, high (%)	Medium	5 to 80/Off	5 to 80/Off	Off	Off	5
PetCO ₂ , high ⁸⁷ (mmHg)	Medium	1 to 100/Off	1 to 100	60	60	1
PetCO ₂ , low ⁸⁷ (mmHg)	Medium	Off/0 to 99	Off/0 to 100	30	30	1
Pressure, high (cmH ₂ O)	High	10 to 120	10 to 120	40	40	1

⁸⁷ CO₂ option required.

Alarm (units)	Priority	Range:	Range:	Default:	Default:	Resolution
		Adult/Ped	Neo	Adult/Ped	Neo	
Pressure, low (cmH2O)	High	2 to 119	2 to 119	5	5	1
Rate, high (b/min)	Medium	2 to 130	2 to 160	<i>Adult:</i> 23 <i>Pediatric:</i> 38	45	1
Rate, low (b/min)	Medium	0 to 128	0 to 158	<i>Adult:</i> 8 <i>Pediatric:</i> 12	12	1
Vt, high ⁸⁸ (ml)	Medium	<i>Adult:</i> 100 to 3000/Off <i>Pediatric:</i> 10 to 500/Off	0 to 250/Off	<i>Adult:</i> 750 <i>Pediatric:</i> 150	40	<i>Adult:</i> OFF 10 (< 1000) 50 (≥ 1000) <i>Pediatric/Neo:</i> OFF 1 (< 100) 10 (≥ 100)
Vt, low ⁸⁸ (ml)	Medium	<i>Adult:</i> Off/50 to 2950 <i>Pediatric:</i> Off/0 to 300	Off/0 to 240	<i>Adult:</i> 250 <i>Pediatric:</i> 50	3	<i>Adult:</i> OFF 10 (< 1000) 50 (≥ 1000) <i>Pediatric/Neo:</i> OFF 1 (< 100) 10 (≥ 100)

⁸⁸ In ASV mode, this alarm only applies for spontaneous breaths.

16.8 Configuration

The following table lists the parameters and settings that can be specified in the Configuration windows. For details, see Chapter 14.

Table 16-10. Configuration specifications

Parameter	Configuration range	Default setting
Language		
Language	English, US English, Bulgarian, Chinese, Croatian, Czech, Danish, Dutch, Finnish, French, German, Greek, Hungarian, Indonesian, Italian, Japanese, Korean, Norwegian, Polish, Portuguese, Romanian, Russian, Serbian, Slovak, Spanish, Swedish, Turkish	English
Customize		
Controls	Inspiratory time philosophy: I:E/Pause, Ti/Pause, %Ti/Pause, Peak Flow/Tip	I:E/Pause
Alarms	ExpMinVol high, Pressure low, Vt high/low, Rate high/low, Leak, Apnea time, Oxygen high, PetCO2 high/low	Enabled
	Min. loudness	1
	FS water alarm	Enabled
Units	CO2 pressure: mmHg, Torr, kPa Length: cm, inch	mmHg cm
Interface		
Insufflation	Open, Closed	Closed
Pause	Open, Closed	Closed
Exhalation	Open, Closed	Closed
Communication protocol	HAMILTON-G5 / Polling, HAMILTON-G5 / Block, HAMILTON-G5 / Block (ACK), Galileo / Polling, DraegerTestProtocol, Humidifier	COM1: Hamilton G5 / Polling COM2: Hamilton G5 / Polling

Parameter	Configuration range	Default setting
Nebulizer		
Type	Internal, External	Internal
MMP selection		
Main monitoring parameters (MMP) ⁸⁹	MMP 1 to 5: Pmean, PEEP/CPAP, Ppeak, Pplateau, Pminimum, AutoPEEP, Driving pressure (ΔP), ExpMinVol, VTI, VTE, VLeak ml, VLeak%, fTotal, fSpont, Oxygen, Cstat, Rinsp, Rexp, I:E, TI, TE, MVSpont, P0.1, PTP, WOBimp, RCexp, RCinsp, RSB, VTESpont, MVLeak, Insp Flow, Exp Flow, Vt/IBW, Ptrans I, Ptrans E, Pcuff (IntelliCuff), T humidifier (HAMILTON-H900)	Ppeak, ExpMinVol, VTE, fTotal, I:E
Defaults		
ASV	ASV, ASV 1.1	ASV 1.1
Display R & Cstat triggered breath	On, Off	Off
Defaults	This information applies to the adult default setup configurations. You can also specify default pediatric and neonatal settings.	
Vent Status		
Oxygen ⁹⁰ (%)	22 to 80	40
PEEP ⁹¹ (cmH2O)	1 to 20	8
Pinsp (cmH2O)	1 to 50	10
%MinVol high (%)	100 to 250	150
%MinVol low (%)	25 to 99	50
RSB high (1 / (l*min))	50 to 150	100
RSB low (1 / (l*min))	0 to 49	10

⁸⁹ Additional parameters available when the CO2 or SpO2 options are installed.

⁹⁰ The low Oxygen setting is always 21%.

⁹¹ The low PEEP setting is always 0 cmH2O.

Parameter	Configuration range	Default setting
P0.1 (cmH ₂ O)	-10 to -1	-3
%fSpont ⁹² (%)	0 to 99	75
VarilIndex high (%)	21 to 50	50
VarilIndex low (%)	0 to 20	20
Parameter display options	RSB, P0.1	RSB
	%fSpont, VarilIndex	%fSpont

⁹² The high %fSpont setting is always 100%.

16.9 ASV technical data

Table 16-11 provides technical data related to ASV.

Table 16-11. ASV technical data

ASV-related data	Specifications
ASV-related operator settings	
%MinVol	25% to 350%
Patient height	Adults: 130 to 250 cm / 50 to 100 in Pediatric: 30 to 150 cm / 12 to 60 in
Internal calculations	
IBW	In kg, calculated based on patient height and sex (see Section 5.3)
MinVol (target)	In l/min, target minute volume is calculated as: $IBW \text{ (in kg)} \times \text{NormMinVent (in l/kg/min)} \times \%MinVol/100$ where NormMinVent is the normal minute ventilation from Figure 7-19.
fTotal	In b/min
VDaw	2.2 ml/kg IBW
Vt (target)	MinVol/ f(target)
ASV monitor	
Target values (numerical)	MinVol, Vt, fTotal
Current achieved values (numerical)	MinVol, Vt, fTotal, $Vt = (VTI+VTE)/2$
Status of patient (numerical)	fSpont, fControl, PInsp
Graphics display (curve)	fTotal versus Vt, target value, current value, safety boundaries
Alarms	
All alarms are functional except apnea alarms	See Chapter 9
Special	ASV: Cannot meet the target alarm

ASV-related data	Specifications
Performance specifications	
Response time (90% of steady state)	< 1 min (typical)
Overshoot/undershoot	< 25%
Maximum pressure change per breath	2 cmH ₂ O
Settling time	< 120 seconds
Steady state deviation	< 10%
Lung-protective rules	
Minimum V _t	4.4 ml/kg x IBW
Maximum V _t depends on	<ul style="list-style-type: none"> • High Pressure alarm limit • Volume/ pressure ratio (V/P) • Always < 15 ml/kg x IBW⁹³ • Limited to 1.5 x high V_t limit
Maximum machine rate	<p>The maximum rate in ASV is the smallest value of the following conditions:</p> <ul style="list-style-type: none"> • 60 b/min • 23 b/min * %MinVol/100 / (IBW = 30 kg) • 23 b/min * %MinVol/ (0.5 to 100 depending on IBW) (IBW < 30 kg) • 20/RC_{exp}
Minimum target rate	5 to 15 b/min (depending on IBW)
Minimum P _{insp}	5 cmH ₂ O above PEEP/CPAP
Maximum P _{insp}	High Pressure alarm limit - 10 cmH ₂ O - PEEP
Minimum inspiratory time (T _I)	0.5 s or RC _{exp} , whichever is longer
Maximum inspiratory time (T _I)	IBW = 30 kg: 2 seconds IBW < 30 kg: 1.5 seconds
Minimum expiratory time (T _e)	0.5 s or 2 x RC _{exp} , whichever is longer
Maximum expiratory time (T _e)	12 seconds
I:E range	1:4 to 1:1

⁹³ Only applicable to ASV 1.1.

16.10 Ventilator breathing system specifications

Table 16-12 lists specifications for the HAMILTON-S1 ventilator breathing system.

Table 16-12. Ventilator breathing system specifications

Parameter	Specification	
Resistance ⁹⁴	Adult circuit (ID19, flow of 60 l/min)	Inspiratory limb: 6.0 cmH2O/60 l/min Expiratory limb: 4.2 cmH2O/60 l/min
	Pediatric circuit (ID15, flow of 30 l/min)	Inspiratory limb: 4.0 cmH2O/30 l/min Expiratory limb: 4.8 cmH2O/30 l/min
	Neonatal circuit (ID10, flow of 5 l/min)	Inspiratory limb: 3.0 cmH2O/5 l/min Expiratory limb: 3.3 cmH2O/5 l/min
Compliance ⁹⁴	Adult circuit (ID19)	2.1 ml/cmH2O
	Pediatric circuit (ID15)	1.9 ml/cmH2O
	Neonatal circuit (ID10)	1 ml/cmH2O
Volume ⁹⁴	Adult circuit (ID19)	2.4 l
	Pediatric circuit (ID15)	1.8 l
	Neonatal circuit (ID10)	0.9 l
Bacteria filter	Particle size	Captures particles of 0.3 mm (micron) with > 99.99% efficiency
	Resistance	< 4 cmH2O at 60 l/min
Flow sensor dead space	Adult/pediatric	< 9 ml (single use)
		< 11 ml (reusable)
	Neonatal	< 1.3 ml (single use)

⁹⁴ As tested, the inspiratory limb includes ambient valve, flow sensor, inspiratory filter, inspiratory tubes, and humidifier. It does not include the heating wire. The expiratory limb includes expiratory tubes, water trap, expiratory valve, and flow sensor.

⁹⁵ Actual patient weight can be much greater (e.g., 300 kg or 661 lb).

⁹⁶ Neither humidity (noncondensing) nor cyclical pressures have any effect on the stated accuracy of the device.

⁹⁷ Per ISO 80601-2-12.

16.11 Technical performance data

Table 16-13 lists technical performance data for the ventilator.

Table 16-13. Technical performance data

Description	Specification
Patient ideal body weight (IBW, determined from Patient height setting)	3 to 139 kg (6.6 to 306 lb) ⁹⁵
Inspiratory pressure	0 to 120 cmH ₂ O
Maximum limited pressure	120 cmH ₂ O
Maximum working pressure	120 cmH ₂ O (PEEP/CPAP + P _{insp}). Ensured through pressure limiting.
Maximum inspiratory flow	180 l/min peak flow, max. 120 l/min continuous flow
Tidal volume/target tidal volume	<i>Adult.</i> 100 to 2000 <i>Pediatric.</i> 20 to 300 ml <i>Neonatal.</i> 2 to 200 ml
Minute volume capability	Up to 60 l/min
Inspiratory time (spontaneous breaths)	0.25 to 3 seconds
Minimum expiratory time	20% of cycle time; 0.2 to 0.8 seconds
Automatic expiratory base flow	<i>Adult/Pediatric.</i> Pressure trigger: 1 l/min Flow trigger setting ≤ 2 l/min: 4 l/min Flow trigger setting > 2 l/min: 2 * Flow trigger Trigger OFF: 1 l/min IntelliSync+: 4 l/min <i>Neonatal.</i> Pressure trigger: 1 l/min Flow trigger setting ≤ 1 l/min: 2 l/min Flow trigger setting > 1 l/min: 2 * Flow trigger Trigger OFF: 1 l/min
Means of inspiratory triggering	Flow trigger control, pressure trigger control, or optional IntelliSync+ control

Description	Specification
Means of expiratory triggering	ETS control or optional IntelliSync+ control
Oxygen mixer accuracy	± (volume fraction of 2.5% + 2.5% of actual reading)
O2 input flow	200 to 600 kPa, max. flow 120 l/min

Measuring devices

Continuous oxygen measurement	The delivered oxygen concentration is continuously measured when an O2 sensor is enabled.	
	<i>Type of sensor: Galvanic O2 sensor</i>	
	Sensing position:	Inspiratory pneumatics
	Measurement, delivered oxygen concentration, range:	18% to 105%
	Response time:	35 seconds
	Initialization time (time from turning on device to operating performance):	< 40 seconds
	Drift:	≤ 3.5% at 60% Oxygen over 6 hours
	Storage temperature:	To maximize the shelf life of unused galvanic O2 sensors, store them between 5°C and 15°C (41°F and 59°F).
Continuous oxygen measurement	<i>Type of sensor: Paramagnetic O2 sensor</i>	
	Sensing position:	Inspiratory pneumatics
	Measurement, delivered oxygen concentration, range:	18% to 100%
	Response time:	< 20 seconds
	Initialization time (time from turning on device to operating performance):	< 8 seconds
	Drift:	± 0.2% oxygen

Description	Specification	
Continuous oxygen measurement	Storage temperature:	To maximize the shelf life of unused paramagnetic O ₂ sensors, store them between -30°C and 70°C (-22°F and 158°F).
Pressure and volume measurements	Type:	Differential pressure transducer, variable orifice
	Sensing position:	Patient y-piece
	Measurements:	See Table 16-6
CO ₂ measurement	Two types of CO ₂ sensors are supported: CAPNOSTAT-5 (mainstream) and LoFlo (sidestream)	
	<i>Type: CAPNOSTAT 5</i>	
	Sensing position:	Mainstream
	Principle of operation:	Nondispersive infrared (NDIR) technology
	Measurements:	See Table 16-6
	Rise time:	< 60 ms
	Initialization time:	Capnogram displayed in < 15 seconds at an ambient temperature of 25°C, full specifications within 2 minutes
	Sampling frequency:	100 Hz
	CO ₂ calculation method:	BTPS
	CO ₂ stability ⁹⁶ :	Short-term drift: ≤ 0.8 mmHg over 4 hours Long-term drift: Accuracy specification maintained over 120 hours
	CO ₂ noise (rms):	≤ 0.25 mmHg at 7.5% CO ₂
	Operating temperature:	0°C to 45°C (32°F to 113°F)
	Storage temperature:	-40°C to 70°C (-40°F to 158°F)
CO ₂ measurement	<i>Type: LoFlo</i>	
	Sensing position:	Sidestream
	Principle of operation:	Nondispersive infrared (NDIR) technology
	Measurements:	See Table 16-6

Description	Specification	
CO2 measurement	Rise time:	200 ms for on-airway adapter kits Additional 30 ms for sidestream sampling can- nulas. Additional 80 ms for extension line and dehu- midification tubing.
	Initialization time:	Capnogram displayed in < 20 seconds at an ambient temperature of 25°C, full specifica- tions within 2 minutes
	Sampling frequency:	100 Hz
	Gas sampling rate:	50 ml/min ±10 ml/min
	CO2 calculation method:	Actual, corrected for temperature and pressure in the sample cell
	CO2 stability ⁹⁶ :	Short-term drift: ≤ 0.8 mmHg over 4 hours Long-term drift: Accuracy specification main- tained over 120 hours
	CO2 noise (rms):	≤ 0.25 mmHg at 5% CO2
	Sensing position:	Inside ventilator
	Measurements:	See Table 16-6
	Operating temperature:	0°C to 40°C (32°F to 104°F)
	Storage temperature:	-40°C to 70°C (-40°F to 158°F)
Tests and special functions	Tightness test, flow sensor/O2 sensor/CO2 sensor zero calibration, O2 enrichment, manual breath, inspiratory hold maneuver, nebulization, leak compensation, communication interface, compensation of breath- ing circuit resistance and compliance, Paux measurement	
Display device	Display of settings, alarms, and monitored data: Type: Color TFT Size: 1024 x 768 pixels, 15 in (381 mm) diagonal	
Brightness setting for display	The range is 25% to 100% brightness. By default, Day is set to 100%; Night is set to 30%.	
Brightness setting for alarm lamp	The range is 20% to 100% brightness. By default, Day is set to 100%; Night is set to 70%.	

Description	Specification
Alarm volume (Loudness)	The range is 1 to 10. The default is 5.
Sound power level ⁹⁷	46.6 dB(A) \pm 3 dB(A)
Sound pressure level ⁹⁷	38.6 dB(A) \pm 3 dB(A)

16.11.1 Accuracy testing

The ventilator's parameter and measurement accuracy is tested using an IMT FlowAnalyser⁵. The tolerance intervals for the data generated by the FlowAnalyser are as specified below, and are included in the accuracy information provided in this manual.

Table 16-14. Tolerance intervals for accuracy testing

Parameter type	Tolerance interval of measurement
Volume	≤ 50 ml: ±1% > 50 ml: ±1.75%
Pressure	±0.75% or ±0.1 cmH ₂ O, whichever is greater
Flow	±1.75% or ±0.5 l/min, whichever is greater
O ₂	±1%

16.11.2 Essential performance

Table 16-15. Essential performance

Component	Requirement
Gas supply failure	Gas supply failure must be detected and the operator informed.
Oxygen level alarm condition	If O ₂ is higher or lower than the set alarm limits, this must be detected and the operator informed through an alarm.
CO ₂ level alarm condition ⁹⁸	If CO ₂ is higher or lower than the set alarm limits, this must be detected and the operator informed through an alarm.

⁹⁸ If option is installed.

Component	Requirement
SpO ₂ level alarm condition ⁹⁸	If SpO ₂ is higher or lower than the set alarm limits, this must be detected and the operator informed through an alarm.
Pressure	The airway pressure must be monitored. If it is higher or lower than the set alarm limits, this must be detected and the operator informed through an alarm.
Volume	The applied and expired volumes must be monitored. If they are higher or lower than the set alarm limits, this must be detected and the operator informed through an alarm.
Electrical supply failure	An electrical supply failure must be detected and the operator informed.
Internal electrical power source nears depletion	The remaining battery capacity must be monitored and qualitatively indicated. At least 5 min prior to depletion, an alarm must be issued.

16.12 Functional description of ventilator system

The HAMILTON-S1 is an electronically controlled pneumatic ventilation system with an integrated air compressing system. It runs on AC power with battery backup to protect against power failure or unstable power and to facilitate intra-hospital transport.

The user provides inputs to the HAMILTON-S1 microprocessor system through a touch screen, keys, and a press-and-turn knob. These inputs become instructions for the HAMILTON-S1's pneumatics to deliver a precisely controlled gas mixture to the patient. The ventilator receives inputs from the proximal flow sensor and other sensors within the ventilator. Based on this monitored data, the ventilator adjusts gas delivery to the patient. Monitored data is also displayed by the graphic user interface.

The ventilator's microprocessor system controls gas delivery and monitors the patient. The gas delivery and monitoring functions are cross-checked by an alarm controller. This cross-checking helps prevent simultaneous failure of these two main functions and minimizes the possible hazards of software failure.

A comprehensive system of visual and audible alarms helps ensure the patient's safety. Clinical alarms can indicate an abnormal physiological condition. Technical alarms, triggered by the ventilator's self-tests including ongoing background checks, can indicate a hardware or software failure. In the case of some technical alarms, a special safety mode ensures basic minute ventilation while giving the operator time for corrective actions.

When a condition is critical enough to possibly compromise safe ventilation, the HAMILTON-S1 is placed into the Ambient state. The inspiratory channel and expiratory valves are opened, letting the patient inspire room air through the inspiratory channel and exhale through the expiratory valve.

The HAMILTON-S1 has several means to ensure that safe patient or respiratory pressures are maintained. The maximum working pressure is ensured by the high

pressure alarm limit. If the set high pressure limit is reached, the ventilator cycles into exhalation. The ventilator pressure cannot exceed 120 cmH₂O.

16.12.1 Gas supply and delivery

The HAMILTON-S1 uses room air, high-pressure oxygen, and optionally heliox (Figure 16-2). Air and oxygen gases (not heliox) enter the ventilator through water traps that have integrated high-efficiency particle filters at the gas inlets.

Figure 16-2. Gas delivery in the HAMILTON-S1

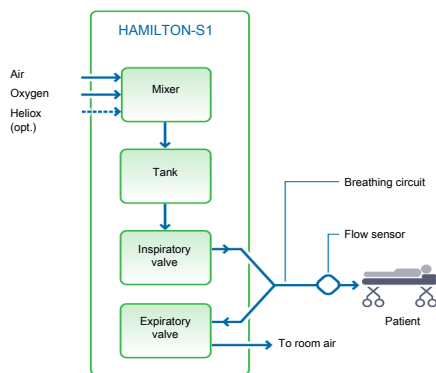

Within the ventilator, the gas enters the ventilator's pneumatic system. An electronic mixer combines oxygen and air/heliox according to the user-set concentration. This mixture fills a reservoir, which is maintained within a prescribed pressure range. As the gas mixture is delivered to the patient, the pressure decreases, and the reservoir is filled.

Gas is supplied to the patient via the inspiratory valve. The microprocessor controls the inspiratory valve opening and the length of time it is open to meet the user settings.

The ventilator delivers gas to the patient through the inspiratory limb breathing circuit parts, which may include one or more of the following: inspiratory filter, flex tubes, humidification system, water traps, Y-piece, and flow sensor. An internal pneumatic nebulizer supplies the nebulizer flow.

Gas exhaled by the patient passes through the expiratory limb breathing circuit parts, which includes one or more of the following: flex tubes, flow sensor, Y-piece, and expiratory valve set. Gas is vented through the expiratory valve housing such that no exhaled gas comes into contact with any internal components of the ventilator. The expiratory valve is heated to reduce the possibility of rainout in the expiratory limb.

Measurements taken at the flow sensor are used in the pressure, flow, and volume measurements.

The ventilator monitors the oxygen concentration of the gas to be delivered to the patient using either a galvanic O₂ sensor (included with the ventilator) or paramagnetic O₂ sensor.

- The galvanic O₂ sensor generates a voltage proportional to the partial pressure of oxygen in the delivered gas.
- The paramagnetic O₂ sensor monitors the oxygen based on the volume magnetic susceptibility of the delivered gas. The paramagnetic O₂ sensor is maintenance free.

The operations of the blower and expiratory valve are coordinated to maintain system pressure levels.

16.12.2 Gas monitoring with the flow sensor

The HAMILTON-S1 accurately measures flow, volume, and pressure in the patient's airway with the Hamilton Medical flow sensor. This proximal flow sensor lets the ventilator sense even weak patient breathing efforts. Between its highly sensitive flow trigger and fast response time, the ventilator helps minimize the patient's work of breathing.

The flow sensor contains a thin membrane within the outer housing and has a pressure port on either side. The membrane allows bidirectional flow through its variable orifice.

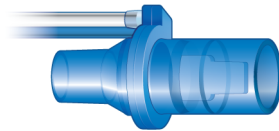

The area of the orifice changes depending on the flow rate. It opens progressively as the flow increases, creating a pressure drop across the orifice. The pressure difference is measured by a high-precision differential pressure sensor inside the ventilator. The pressure difference varies with flow (relationship determined during flow sensor calibration), so the patient's flow is determined from the pressure drop. The ventilator calculates volume from the flow measurements.





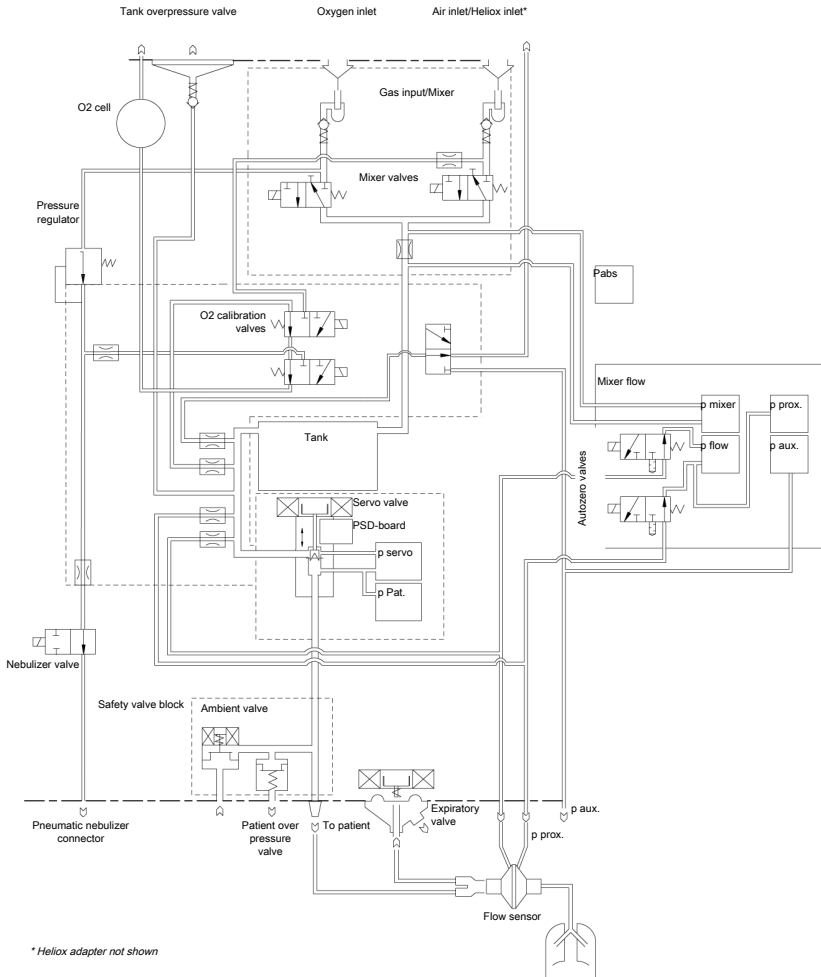



The flow sensor is highly accurate even in the presence of secretions, moisture, and nebulized medications. The ventilator flushes the sensing tubes with mixed gases (rinse flow) to prevent blockage.

16.12.3 Pneumatic diagram



















16.13 Symbols used on device labels and packaging

Table 16-16. Symbols used on device, device labels, and packaging

Symbol	Definition
	Standby key
	Power button
	To patient inspiratory port
	From patient expiratory port
	Alarm Off
	Manufacturer
	Date of manufacture
	Refer to the operator's manual for complete information.
	Symbol for "Caution". Applied parts not protected against defibrillation.
CE 0197	CE Marking of Conformity, seal of approval guaranteeing that the device is in conformance with the Council Directive 93/42/EEC concerning medical devices

Symbol	Definition
	The TÜV NRTL mark with the indicators "C" and "US" means that the product complies with Canadian requirements and the requirements of US authorities for safety.
	Dispose according to Council Directive 2002/96/EC or WEEE (Waste Electrical and Electronic Equipment)
	Serial number
	This way up at transport and storage
	Fragile, handle with care at transport and storage
	Keep dry at transport and storage
	Temperature limitations at transport and storage
	Humidity limitations at transport and storage
	Atmospheric pressure limitations at transport and storage
	Stacking limitations at transport and storage
	Recyclable material





Symbol	Definition
	Mass
	Single use
	Autoclavable. Autoclavable parts can be used inside an autoclave (for example, a steam autoclave) without damage. These parts withstand temperatures up to approximately 134°C. The correct way to reprocess autoclavable parts is described in the <i>Reprocessing Guide</i> provided by the manufacturer. Parts that Hamilton Medical terms as <i>autoclavable</i> can undergo autoclaving with steam sterilization without damage.
	Reusable. A reusable part is a medical device or part of a medical device that can be reused if it undergoes some sort of reprocessing between use on different patients. The correct way to reprocess reusable parts is described in the <i>Reprocessing Guide</i> provided by the manufacturer. Parts that Hamilton Medical terms as <i>reusable</i> cannot be autoclaved with steam sterilization.

Symbol	Definition
	Type B applied part (classification of medical electrical equipment, type B, as specified by IEC 60601-1)
	Type BF applied part (classification of medical electrical equipment, type BF, as specified by IEC 60601-1)
	Fuse
	Alternating current
	HAMILTON-H900 power strip The power strip is intended for the HAMILTON-H900 humidifier <i>only</i> . You must <i>not</i> connect any other devices.
	Applicable to neonatal patient group
	Applicable to pediatric patient group
	Applicable to adult patient group
	Applicable to neonatal/pediatric patient groups
	Applicable to pediatric/adult patient groups
	Applicable to all patient groups
	Terminal for the connection of a potential equalization conduction.

Symbol	Definition
IP21	Protected against dripping water and solid particles larger than 12.5 mm.
	HAMILTON-S1 poses unacceptable risks to the patient, medical staff, or other persons within the MR environment.

16.13.1 Symbols used on the trolley

Table 16-17. HAMILTON-S1 trolley warning labels

Label	Description
	Make sure the wheel brakes are unlocked when moving the trolley.
	Do not lean on the trolley.
	Do not park the trolley on an incline greater than 5 degrees.
	<p>Weight</p> <p><i>Applies to the standard trolley</i></p> <p>The maximum safe working load with the standard trolley applies to a stationary properly load-balanced trolley.</p>

Label	Description
	<p>Weight</p> <p><i>Applies to the universal trolley</i></p> <p>The maximum safe working load with the universal trolley applies to a stationary properly load-balanced trolley.</p>

16.14 Standards and approvals

The HAMILTON-S1 was developed in accordance with pertinent international standards and FDA guidelines.

The ventilator is manufactured within an EN ISO 13485 and EN ISO 9001, Council Directive 93/42/EEC, Annex II, Article 3 certified quality management system.

The ventilator meets the Essential Requirements of Council Directive 93/42/EEC, Annex I.

Where standards are mentioned, the HAMILTON-S1 complies with the versions listed in Table 16-19.

The ventilator meets relevant parts of the following standards, listed in Table 16-18.

Table 16-18. Standards

IEC 60601-1	Medical electrical equipment, Part 1: General requirements for basic safety and essential performance. The device classification is: Class I, Type B applied part (ventilator breathing system, VBS), type BF applied part (CO2 sensor including CO2 module connector, humidifier, Aerogen system, nebulizer, and SpO2 sensor including SpO2 adapter), continuous operation
IEC 60601-1-2	Medical electrical equipment - Part 1-2: General requirements for basic safety and essential performance. <ul style="list-style-type: none"> • Collateral standard: Electromagnetic compatibility • Requirements and tests
ISO 80601-2-12	Medical electrical equipment - Part 2-12: Particular requirements for the basic safety and essential performance of critical care ventilators

Table 16-19. Standards and approvals, valid versions

IEC 60601-1-2:2014
IEC 60601-1:2005/A1:2012
IEC 60601-1-8:2006/A1:2012
ISO 80601-2-12:2011 + Cor.:2011
IEC 61000-3-2:2005
IEC 61000-3-3:2008
IEC 61000-4-2:2008

IEC 61000-4-3:2006 + A1:2007+A2:2010
IEC 61000-4-4:2004
IEC 61000-4-5:2005
IEC 61000-4-6:2013
IEC 61000-4-11:2004
EN ISO 13485:2012/AC:2012
IEC 60950-1:2013
EN ISO 9001:2008
EN ISO 5356-1:2004

16.15 Disposal and year of manufacture

Disposal

The device must be disposed of according to your institution's protocols and Directive 2002/96/EC.

All parts removed from the device must be considered contaminated, and pose infection risk.

Dispose of all parts removed from the device according to your institution's protocol. Follow all local, state, and federal regulations with respect to environmental protection, especially when disposing of the electronic device or parts of it (for example, O2 sensor, batteries).

Year of manufacture

The year of manufacture is shown on the serial number label on the HAMILTON-S1 ventilation unit.

16.16 Warranty

LIMITED WARRANTY

THE WARRANTY DESCRIBED IN THIS AGREEMENT IS IN LIEU OF ANY AND ALL OTHER WARRANTIES, EXPRESS OR IMPLIED, INCLUDING IMPLIED WARRANTIES OF MERCHANTABILITY AND FITNESS FOR A PARTICULAR PURPOSE. HOWEVER, IMPLIED WARRANTIES ARE NOT DISCLAIMED DURING THE PERIOD OF THIS LIMITED WARRANTY.

Hamilton Medical guarantees its products to be shipped free from defects in material and workmanship.

The warranty does not include disposable items. Disposable items and consumable products are considered to be of single use or of limited use only and must be replaced regularly as required for proper operation of the product following the operator's manual.

Hamilton Medical and the manufacturer shall have no obligations nor liabilities in connection with the product other than what is specified herein, including without limitation, obligations and/ or liabilities for alleged negligence, or for strict liability.

In no event shall the company be liable for incidental or consequential damages, either direct or contingent.

This Limited Warranty shall be void and not apply:

1. If the product has not been installed and connected by an authorized local representative of Hamilton Medical in accordance with the instructions furnished by Hamilton Medical and by a Hamilton Medical representative.
2. If replacements and/or repairs have not been performed by authorized or properly trained personnel.
3. If no evidence is present that the occurrence of damage/ repair happened within the certified warranty period.
4. If the serial number has been altered, effaced or removed and there is no bill of sale or evidence to verify the product's purchase date.
5. If the defects arise from misuse, negligence, or accidents or from repair, adjustment, modification or replacement made outside Hamilton Medical's factories or other than an authorized service center or authorized service representative.
6. If the product has been modified, or in any nature altered without prior written authorization from Hamilton Medical.
7. If yearly maintenance is not performed.
8. If the product is or has been used in any way that is not specified under "Intended Use" (see "General cautions and notes").

9. If the product has been used by anyone but properly trained personnel under the supervision of a physician. Replacements and/or repairs furnished under this Limited Warranty do not carry a new warranty, but carry only the unexpired portion of the original Limited Warranty. The warranty of repaired and/or replaced components does not exceed the Limited Warranty of the device.

To obtain service under this Limited Warranty, claimant must promptly notify the country's sales partner of Hamilton Medical regarding the nature of the problem, serial number and the date of purchase of the Product.

Except as stated above, Hamilton Medical shall not be liable for any damages, claims or liabilities including, but not limited to, personal bodily injury, or incidental, consequential, or special damages. Nor will Hamilton Medical be liable for any damages, claims or liabilities including, but not limited to, personal bodily injury, or incidental, consequential, or special damages resulting from misuse of the device or failure to comply with any of the provisions made in this manual.

The general terms and conditions of Hamilton Medical shall be applicable. This agreement shall be governed by and construed in accordance with the laws of Switzerland and may be enforced by either party under the jurisdiction of the court of Chur, Switzerland.

%MinVol

Percentage of minute ventilation, a control setting in ASV mode

(S)CMV

Synchronized controlled mandatory ventilation, a ventilation mode

alarm lamp

Lamp atop the ventilator that lights in a color corresponding to the active alarm

Alarm Off symbol

Displayed when the associated alarm limit is disabled (set to Off)

ambient state

An emergency state in which the ventilator opens the inspiratory channel and expiratory valve; this allows the patient breathe room air unassisted by the ventilator

Apnea time

The maximum time allowed without a breath trigger, an alarm setting

APRV

Airway pressure release ventilation, a ventilation mode

APVcmv

Adaptive pressure ventilation with controlled mandatory ventilation, a ventilation mode; can also be shown as (S)CMV+ (configurable)

APVsimv

Adaptive pressure ventilation with synchronized intermittent mandatory ventilation, a ventilation mode; can also be shown as SIMV+ (configurable)

ASV

Adaptive support ventilation mode. ASV adjusts pressure and rate on a breath-by-breath basis, taking into account changing patient conditions and applying lung-protective strategies to meet the targets.

ASV Graph

An Intelligent panel that shows ASV target and patient data graphically, available in ASV mode

Audio Pause key

Temporarily silences the audible alarm sound for 2 minutes

AutoPEEP

Unintended positive end-expiratory pressure, a monitored parameter

b/min

Breaths per minute

backup

Apnea backup ventilation

backup buzzer

A buzzer that sounds for at least 2 minutes in certain conditions; also functions as a backup for the ventilator loudspeaker

base flow

A continuous and constant gas flow from the inspiratory outlet to the expiratory outlet

breathing circuit

Includes the inspiratory-expiratory limbs, humidifier, filters, flow sensors, and any water traps

BTPS

Body temperature, barometric pressure at sea level, saturated with water vapor

CE

A certification mark that indicates compliance with the Medical Device Directive, 93/42/EEC

cmH₂O

Centimeters of water; 1 cmH₂O is approximately equal to 1 mbar, which equals 1 hPa

COPD

Chronic obstructive pulmonary disease

CPAP

Continuous positive airway pressure

Cstat

Static compliance, a monitored parameter

DAS

Distributed alarm system

Driving pressure (ΔP)

A calculated value showing the ratio of tidal volume to static compliance, which reflects the difference between P_{plateau} and PEEP total; can provide information to help optimize ventilation for ARDS patients

DuoPAP

Duo positive airway pressure, a ventilation mode

Dynamic Lung

Intelligent Panel that graphically represents tidal volume, lung compliance, patient triggering, and resistance in real time

EMC

Electromagnetic compatibility

EMI

Electromagnetic interference

EN

European norm, a European standard

ET

Endotracheal

ETS

Expiratory trigger sensitivity, a control setting

event log

A record of clinically relevant ventilator occurrences, including alarms, settings changes, calibrations, maneuvers, and special function uses that have occurred since the ventilator was turned on

Exp Flow

Peak expiratory flow, a monitored parameter

ExpMinVol

Expiratory minute volume, a monitored parameter and alarm setting; in the Vent Status panel, ExpMinVol is the percentage of normal minute ventilation based on IBW

f

Respiratory rate

FDA

United States Food and Drug Administration

FetCO₂

Fractional end-tidal CO₂ concentration, a monitored parameter

Flow

Flow of gas to the patient during high flow oxygen therapy, a monitored parameter

fSpont

Spontaneous breathing frequency, a monitored parameter

fTotal

Total breathing frequency, a monitored parameter and alarm setting

Gender

Sex of patient, a control setting

Hi Flow O₂

High flow oxygen therapy, a ventilation mode

HME, HMEF

Heat and moisture exchanger (artificial nose), heat and moisture exchanging filter

I:E

Ratio of inspiratory time to expiratory time, a setting, timing parameter, and monitored parameter

IBW

Ideal body weight, a calculated value for adult and pediatric patients based on the patient's sex and height; used as the basis for initial settings of various parameters

ID

Inner diameter

IEC

International Electrotechnical Commission

Insp Flow

Peak inspiratory flow, a monitored parameter

inspiratory hold

An inspiratory hold closes the inspiratory and expiratory valves for a short time. Perform this maneuver to calculate true plateau airway pressure.

IntelliCuff

Cuff pressure controller

Intelligent Panel

A type of graphic display on the ventilator

IntelliSync+

Option that allows the device to dynamically update the inspiratory or cycling trigger. It does so by using a complex set of algorithms to analyze and process incoming sensor signals, allowing the ventilator to set values that are appropriate for the patient and system conditions.

IntelliTrig

Intelligent trigger, a feature that ensures that the set trigger sensitivity can trigger a breath independent from leakage and breath pattern

INTELLIVENT-ASV

Fully closed loop ventilation solution, automatic MinVol, PEEP, and Oxygen adjustment based on physiological patient conditions

IRV

Inverse ratio ventilation

ISO

International Organization for Standardization

loudness

Sets the volume for the audible ventilator alarms

LSF

Least squares fitting method; a mathematical procedure for finding the best fitting curve for a given set of points by minimizing the sum of the squares of the offsets of the points from the curve

mandatory breath

The start of inspiration (triggering) is determined by the ventilator or the patient. The end of inspiration (cycling) is determined by the ventilator.

manual breath

A user-triggered mandatory breath started by pressing the Manual breath key

MinVol

Minute volume, a calculated and monitored parameter used in ASV mode; based on the operator-set %MinVol, the ventilator calculates the target MinVol in l/min, then measures and displays this value in the ASV Graph

MVLeak

Total minute volume leakage; MVLeak shows VLeak * frequency (respiratory rate)

MVSpont

Spontaneous expiratory minute volume, a monitored parameter

nCPAP-PS

A neonatal ventilation mode that offers nasal continuous positive airway pressure - pressure support through a nasal interface (mask or prongs) for infants and neonates

NIST

Noninterchangeable screw thread, a standard for high-pressure gas inlet fittings

NIV

Noninvasive ventilation, a ventilation mode

NIV-ST

Spontaneous/timed noninvasive ventilation, a ventilation mode

NPPV

Noninvasive positive pressure ventilation

O2 sensor

Monitors the oxygen concentration delivered to the patient

OD

Outer diameter

Oxygen

Oxygen concentration of the delivered gas, a control setting and a monitored parameter

P ASV limit

Maximum pressure to be applied in ASV, a control setting

P high

High pressure in APRV and DuoPAP modes

P low

Low pressure setting in APRV mode

P&T knob

Press-and-turn knob; used to navigate the display, select list items, activate controls, and set values

P0.1

Airway occlusion pressure, a monitored parameter

patient group

A control setting used to define initial startup settings for the patient; options are Adult, Pediatric, and Neonatal

Patient height

Patient height; a control setting used to compute the patient's ideal body weight (IBW) in calculations for ASV and startup settings

Paux

Auxiliary pressure, a monitored parameter

Paw

Airway pressure

P-CMV

Pressure controlled ventilation, a ventilation mode

Pcontrol

Pressure control, a control setting in PCV+ and PSIMV+ modes; pressure (additional to PEEP/CPAP) to be applied during the inspiratory phase

Pcuff

Cuff pressure, a monitored parameter (for the IntelliCuff cuff pressure controller)

PEEP/CPAP

PEEP (positive end-expiratory pressure) and CPAP (continuous positive airway pressure), a control setting and monitored parameter; PEEP and CPAP are constant pressures applied during both the inspiratory and expiratory phases

PetCO₂

Partial pressure of end-tidal CO₂, the measure of CO₂ present in the exhaled air

Pinsp

Inspiratory pressure, the target pressure (additional to PEEP/CPAP) to be applied during the inspiratory phase. Set by the operator in the PSIMV +PSync and NIV-ST modes; displayed in the Vent Status panel and the ASV Graph.

Pmean

Mean airway pressure, a monitored parameter

Pminimum

Minimum airway pressure of the previous breath cycle

PN

Part number

Ppeak

Peak airway pressure, a monitored parameter

Pplateau

Plateau or end-inspiratory pressure

P-ramp

Pressure ramp, a control setting

Press-and-turn knob

See P&T knob

pressure control

Maintenance of a consistent transrespiratory pressure waveform despite changing respiratory system mechanics

pressure trigger

The patient's inspiratory effort that causes the ventilator to deliver a breath, a control setting

P-SIMV

Pressure-controlled synchronized intermittent mandatory ventilation, a ventilation mode

Psupport

Pressure support, a control setting valid during spontaneous breaths in SPONT, SIMV+, APVsimv, PSIMV +PSync, DuoPAP, and NIV modes. Psupport is pressure (additional to PEEP/CPAP) to be applied during the inspiratory phase.

PTP

Inspiratory pressure time product, a monitored parameter

Rate

Breath frequency or number of breaths per minute, a control setting

RCexp

Expiratory time constant, a monitored parameter

RC_{insp}

Inspiratory time constant, a monitored parameter

R_{exp}

Expiratory flow resistance, a monitored parameter

R_{insp}

Inspiratory flow resistance, a monitored parameter

RSB

Rapid shallow breathing index, a monitored parameter

sigh

Breaths delivered to deliberately increase tidal volume at a regular interval. If enabled, a sigh breath with an additional 10 cmH₂O is delivered every 50 breaths. Note that in volume-controlled modes, a sigh breath delivering 150% of the set tidal volume is delivered every 50 breaths.

SIMV

Synchronized intermittent mandatory ventilation, a ventilation mode

slopeCO₂

Slope of the alveolar plateau in the PetCO₂ curve, a monitored parameter

SPONT

Spontaneous (pressure support) mode of ventilation, a ventilation mode

spontaneous breath

A breath for which both the inspiratory and expiratory triggers are controlled by the patient; the patient both triggers and cycles the breath

Standby

The ventilator is in a waiting state; there is no breath delivery

T high

Set time interval for the high pressure level in the APRV and DuoPAP modes

T humidifier

Measured temperature at the humidifier water chamber exit, a monitored parameter (for HAMILTON-H900 humidifier only)

T low

Set time interval for the low pressure level in APRV mode

TE

Expiratory time, a monitored parameter

technical fault

A type of alarm generated when the ventilator's ability to safely ventilate the patient may be at risk

TI

Inspiratory time, a control setting and monitored parameter

TI max

Maximum inspiratory time, a control setting

touch screen

The glass portion of the monitor that you touch to interact with the display elements

Trends

A special graphic type

trigger

The patient's inspiratory effort that causes the ventilator to deliver a breath, a control setting; controlled by flow or pressure

V'_{alv}

Alveolar minute ventilation, a monitored parameter

V'CO₂

Net exhaled volume of CO₂, a monitored parameter

VDaw

Airway dead space

VDaw/VTE

Airway dead space fraction at the airway opening, a monitored parameter

VeCO₂

Expiratory CO₂ volume, a monitored parameter

Vent Status panel

An Intelligent Panel that illustrates six parameters related to the patient's ventilator dependence, including oxygenation and patient activity

ventilator breathing system (VBS)

A breathing system bounded by the low-pressure gas input port(s), the gas intake port(s), and the patient connection port, together with the fresh-gas inlet and exhaust port(s), if fresh-gas inlet or exhaust ports are provided, as described in ISO 4135

ViCO₂

Inspiratory CO₂ volume, a monitored parameter

VLeak

Leakage percent, a monitored parameter

VS

Volume Support, a ventilation mode; provides volume-controlled flow-cycled breaths for spontaneously breathing patients

Vt

Tidal volume; a control setting, alarm setting, and monitored parameter

Vt/IBW

Tidal volume calculated according to ideal body weight, used for adult/pediatric patients; a monitored parameter

Vt/Wt

Tidal volume calculated according to actual body weight, used for neonatal patients; a monitored parameter

Vtalv

Alveolar tidal ventilation, a monitored parameter

VTE

Expiratory tidal volume, a monitored parameter; it is the integral of all negative flow measurements during exhalation

VTESpont

Spontaneous expiratory tidal volume, a monitored parameter

VTI

Inspiratory tidal volume, a monitored parameter

Waveforms

A special graphic type

WOBimp

Imposed work of breathing, a monitored parameter

Icons

- %MinVol parameter 99, 287
- %TI parameter 99, 287
- (S)CMV ventilation mode 116, 118

A

- accessories, list of 274
- Aerogen nebulizer
 - activating option 271
 - setup overview 76
- air/dust filters, replacing 258
- alarm tests
 - about 86
 - apnea alarm 88
 - disconnection on patient side alarm 88
 - exhalation obstructed alarm 88
 - high pressure alarm 87
 - loss of external power alarm 88
 - low minute volume alarm 87
 - low oxygen alarm 87
- alarms
 - about 184
 - active, viewing 187
 - audio pause, enabling 187
 - buffer, about 187
 - HAMILTON-H900 humidifier 243
 - i-icon (alarm buffer) 188
 - inactive, viewing 187
 - indicators, about 184, 185
 - IntelliCuff, about 251
 - limit disabled symbol 186
 - limits, setting 96
 - limits, where shown 186
 - list of 189
 - loudness, setting 189
 - responding to 187
 - silencing (audio pause) 187
 - status indicator on ventilator 48
 - troubleshooting 189
- alarms, adjustable
 - about 96
 - Apnea time 97
 - enabling/disabling 265
 - ExpMinVol 97
 - fTotal 97
 - Leak 97
 - limits, setting 96

- PetCO2 97
- Pressure 97
- specifications 299
- Vt 97
- Ambient state 138
- Apnea backup 93, 99, 287
- Apnea time alarm 97, 299
- APRV ventilation mode 116, 129
- APVcmv ventilation mode 116, 122
- APVsimv ventilation mode 116, 124
- ASV Graph
 - about 170
 - displaying 170
- ASV Monitoring panel
 - about 171
 - displaying 171
- ASV ventilation mode 116, 131
 - functional overview 146
 - maintaining adequate ventilation 143
 - monitoring ventilation 144
 - weaning, overview 145
 - working with 141
- audio pause (alarm silence)
 - alarms not affected by 186, 206
 - enabling 187
- AutoPEEP parameter 173, 292

B

- batteries
 - about 60
 - power states, about 61
 - storage 260
- breath timing options 114
 - selecting 264
- breath types 114
- breathing circuit diagrams (adult/pediatric)
 - coaxial with HMEF 50
 - dual limb with humidifier 50
 - high flow oxygen 51
- breathing circuit diagrams (Neo)
 - high flow oxygen 53
 - nCPAP-PS 54
 - with HMEF 52
 - with humidifier 52

- breathing circuits
 - connection diagrams 50
 - connection overview 62
 - expiratory valve, installing 63
 - filters, using in 64
 - flow sensor, connecting 65
 - key connection ports on ventilator 63
 - positioning 65, 108
 - selecting components for (adult/pediatric) 64
 - selecting components for (Neo) 107
- buffer, alarm 187

C

- calibration
 - CO2 sensor/adaptor 85
 - flow sensor 83, 110
 - O2 sensor 84
 - Tests & calibs window, accessing 80
- cleaning components and ventilator
 - agents for touch screen 256
 - general guidelines 254
- cleaning methods 255
- CO2 alarms 97, 299
- CO2 measurement
 - activating option 271
 - CO2-related parameters 180, 295
 - enabling 74
 - mainstream monitoring, about 71
 - overview 70
 - sidestream monitoring, about 73
 - zero calibration, performing 85
- communication interface, selecting 266
- configuration
 - adjustable alarms, enabling/disabling 265
 - Aerogen, activating option 271
 - alarm loudness, setting minimum 265
 - breath timing options, selecting 264
 - CO2, activating option 271
 - communication interface, selecting 266
 - Configuration mode, accessing 264
 - copying configuration settings to other devices 271
 - default settings for patient group, defining 268
 - flow sensor water sensitivity, setting 265
 - humidifier, activating option 271
 - IntelliCuff, activating option 271

- language, setting 264
- MMPs, selecting what to show 266
- software options, activating 270
- SpO2, activating option 271
- units of measure, selecting 264
- Vent Status parameters 266
- control parameters
 - adjusting 57
 - defined 98
 - settings, changing 58, 211
 - specifications for 287
- Controls window 90
 - opening 90
 - settings for ventilation, adjusting 90
- Cstat parameter 177, 294
 - in Dynamic Lung 166
- Cycle (ETS, IntelliSync+) parameter 103
- cycling (ETS, IntelliSync+), selecting method for 90

D

- date/time, setting 220
- default settings
 - about 79
 - configuring for ventilator 268
- device information, viewing 182
- disinfecting components
 - general guidelines 254, 255
- display
 - brightness, setting 221
 - navigating 57
- Distributed alarm system (DAS) 205
- documentation
 - conventions used in manual 20
 - manuals for ventilator, list of 19
- Driving pressure (ΔP) parameter 292
- Driving pressure, ΔP 173
- DuoPAP ventilation mode 116, 128
- Dynamic Lung
 - about 165
 - airway resistance (Rinsp) 167
 - compliance (Cstat) 166
 - displaying 168
 - IntelliCuff data 167
 - patient trigger 167
 - SpO2 data 167

E

- EMC-related safety information 22
- End PEEP parameter (P/V Tool) 287
- esophageal pressure
 - measuring 171
 - setting up for monitoring 66
- ETS parameter 287
- Event log
 - about 219
 - viewing 220
- Exp Flow parameter 175, 293
- expiratory hold, performing 216
- expiratory valve, installing 63
- ExpMinVol parameter 175, 293

F

- FetCO2 parameter 180, 295
- filters, using in breathing circuit 64
- Flow parameter 175, 287, 293
- flow sensor
 - calibration 83, 110
 - connecting (adult/pediatric) 65
 - connecting (Neo) 108
 - water sensitivity (Neo), setting 265
- FlowPattern parameter 99, 287
- flow-related parameters 175, 293
- fSpont parameter 176, 294
- fTotal parameter 176, 294
- function keys on front of ventilator, about 211

G

- gas source, selecting 62
- gas supply
 - connecting 61
 - functional description of 313
 - selecting gas source on ventilator 62
- gender (sex) 99
- graphics on display
 - contents of, changing 157
 - Intelligent panels, about 165
 - layout, changing 157
 - loops 164
 - trends 163

- types of 156
- waveform view options 159

H

- Hamilton Medical College website 19
- Heliox
 - preoperational check using, overview 82
 - selecting as gas source 62
 - working with 61
- high flow oxygen
 - about 137
 - breathing circuit diagrams (adult/pediatric) 51
 - breathing circuit diagrams (Neo) 53
 - controls for 116
 - delivering 137
 - safety information 33
- hold
 - expiratory, performing 216
 - inspiratory, performing 215
- humidifier
 - connecting 68
 - setup overview 68
- humidifier (HAMILTON-H900)
 - activating option 271
 - adjustable controls, about 240
 - alarms 242, 243
 - connecting to ventilator 69
 - controls on ventilator, accessing 237
 - data, where displayed 244
 - integration with ventilator, about 236
 - parameters, list of 244
 - quick access button, about 238
 - settings, changing 241
 - Standby, entering 241
 - turning on/off 241
- humidifier alarms (HAMILTON-H900)
 - alarm sound, pausing (silencing) 242
 - list of 243
 - status indicators, about 238
 - troubleshooting 243
 - where/how displayed 242
- humidifier modes and controls (HAMILTON-H900)
 - Auto/Manual control modes 239
 - controls 296
 - Exp. temp increase parameter 240
 - humidifier operating modes, about 238
 - Invasive, NIV, Hi Flow O2 238

Set temp parameter 240
 T gradient parameter 240
 T humidifier parameter 244
 T y-piece parameter 244

I

I:E parameter 99, 176, 288, 294
 IBW parameter 177
 i-icon (alarm buffer), about 188
 Insp Flow parameter 175, 293
 inspiratory hold, performing 215
 IntelliCuff
 activating option 268, 271
 alarms 250
 connecting to patient/ventilator 70
 controls 296
 controls on ventilator, accessing 246
 cuff pressure, setting 249
 deflating cuff 250
 integration with ventilator 69
 Last Patient settings used 252
 parameters, list of 252
 quick access button, about 247
 status indicators, about 247
 tubing, about 69, 70
 turning on/off 247
 working with, overview 245
 IntelliCuff alarms
 list of 251
 troubleshooting 251
 where/how indicated 250
 IntelliCuff modes and controls
 Auto/Manual control modes, about 248
 cuff pressure during recruitment 249
 Cuff pressure parameter 252
 IntelliCuff parameter 252
 Max. pressure parameter 252
 Min. pressure parameter 252
 parameters, list of 252
 Pcuff parameter 167, 252
 Rel. pressure parameter 252
 Intelligent panels
 about 165
 ASV Graph 170
 ASV Monitoring 171
 Dynamic Lung 165

types of 157
 Vent Status 168
 INTELLiVENT-ASV ventilation mode 116, 133

K

keys on front of ventilator, about 211

L

language, setting 264
 leak alarms 97, 299
 Leak parameter 175
 list items, selecting 58
 loops
 about 164
 displaying 164
 storing 164
 types of 157
 loudness, setting for alarms 189

M

main display, overview of 48
 main monitoring parameters (MMPs)
 selecting what to show 266
 viewing 154
 mainstream CO2 measurement
 about 71
 setting up 72
 maintenance
 air/dust filters, replacing 258
 battery, storage 260
 cleaning guidelines 254
 disinfection guidelines 255
 O2 sensor (galvanic), replacing 259
 preventive 256
 manual breath, delivering 215
 MinVol NIV parameter 175, 293
 monitor, adjusting tilt angle and position 56
 monitored parameters 292
 defined 173
 specifications for 292
 monitoring ventilation
 about 154

- main monitoring parameters (MMPs) 154
 - parameter values, viewing graphically 156
 - parameter values, viewing numeric 154
 - secondary monitoring parameters (SMPs), about 155
 - MVLeak parameter 175, 294
 - MVSpO₂ NIV parameter 175, 293
 - MVSpont parameter 175, 293
 - MyHamilton website 19
- N**
- navigating the display 57
 - nCPAP-PS ventilation mode 116, 136
 - nebulizer
 - Aerogen, setup overview 76
 - configuring options 268
 - duration of nebulization, setting overview 75
 - pneumatic, about 217
 - pneumatic, setting up 75
 - pneumatic, setup overview 75
 - starting/stopping 217, 218
 - neonatal ventilation
 - breathing circuit diagrams 52, 53, 54
 - breathing circuit, setting up 107
 - flow sensor, connecting 108
 - patient data, entering 106
 - preoperational check, overview 109
 - setting up for 106
 - NIV ventilation mode 116, 134
 - NIV-ST ventilation mode 116, 135
 - noninvasive (NIV) ventilation
 - alarms during 140
 - conditions for use 138
 - contraindications for use 139
 - notes for use 141
 - working with 138
- O**
- O₂ enrichment, delivering 213
 - O₂ sensor
 - calibrating 84
 - enabling 74
 - replacing 259
 - Oxygen parameter 99, 177, 288, 294
 - oxygen supply, connecting 61
- P**
- P ASV limit parameter 100, 288
 - P high parameter 100, 288
 - P low parameter 100, 288
 - P/V Tool Pro
 - about 224
 - accessing 226
 - contraindications for use 225
 - control specifications 296
 - maneuver data, reviewing 232
 - maneuver data, views of 229
 - maneuver, performing 228
 - parameter specifications 296
 - recruitment maneuver, performing 233
 - reference curves, about 232
 - settings, adjusting 227
 - using 225
 - when to use 224
 - PO.1 parameter 177, 294
 - parts, list of 274
 - patient data
 - changing 210
 - entering 79
 - main monitoring parameters (MMPs) 154
 - secondary monitoring parameters (SMPs), about 155
 - viewing graphically 156
 - viewing numeric data 154
 - Patient height parameter 100, 288
 - patient setup
 - default settings, about 79
 - entering patient data 78, 106
 - overview of 78
 - Pause parameter 100, 288
 - Paux parameter 173
 - Paw (pressure/time) waveform, about 160
 - P-CMV ventilation mode 116, 126
 - Pcontrol parameter 100, 288
 - Peak flow parameter 100, 288
 - PEEP/CPAP parameter 100, 173, 288
 - Pes (Paux) port on ventilator, about 171
 - PetCO₂ parameter 180, 295

P_{insp} parameter 174
 P_{mean} parameter 174, 292
 P_{minimum} parameter 174, 292
 power supply
 batteries, about 60
 power states, about 61
 primary power, connecting to 60
 status indicators on ventilator 48
 P_{peak} parameter 174, 292
 P_{plateau} parameter 174, 292
 P-ramp parameter 101, 289
 preconfigured settings (defaults),
 about 79
 preoperational check
 flow sensor calibration, performing 83,
 110
 overview 81
 overview of 80, 109
 performing 81, 109
 test breathing circuit setup (adult/
 pediatric) 81
 test breathing circuit setup (Neo) 109
 testing alarms 86
 Tests & calibs window, accessing 80
 tightness test, performing 82
 with Heliox, overview 82
 preparing for ventilation, overview 60
 pressure
 esophageal, measuring 171
 transpulmonary, calculating 171
 pressure alarms 97, 299
 pressure-related parameters 173, 292
 P-SIMV ventilation mode 116
 P_{start} parameter (P/V Tool) 289
 P_{support} parameter 101, 289
 P_{top} parameter (P/V Tool) 289
 PTP parameter 178, 294
 P_{trans E} parameter 174, 292
 P_{trans I} parameter 174, 292
 Pulse oximetry (SpO₂), about 74

R

Ramp speed parameter (P/V Tool) 289
 rate alarms 97, 299
 Rate parameter 101, 289

RC_{exp} parameter 178, 294
 RC_{insp} parameter 179, 294
 R_{exp} parameter 179, 294
 R_{insp} parameter 179, 294
 in Dynamic Lung 167
 RSB parameter 179, 294

S

safety information 22
 alarms 33
 apnea backup 32
 breathing circuits and accessories 26
 CO₂ sensors 29
 electrical 24
 EMC 22
 fire/hazards 23
 gas supply 25
 general operation and setup 23
 high flow oxygen 33
 humidifiers 28
 IntelliCuff 28
 maintenance and cleaning/
 disinfection 34
 maintenance, cleaning/disinfection 34
 monitoring 33
 nebulization 30
 neonatal ventilation 31
 noninvasive ventilation 32
 P/V Tool Pro 33
 patient settings 31
 power and batteries 24
 preoperational checks 27
 preventive maintenance 36
 service and testing 37
 TRC 32
 trolley 34
 screenshot of display, capturing 219
 secondary monitoring parameters (SMPs)
 displaying 155
 sensors, enabling 74
 setting up for ventilation, overview 60
 sex 287
 sidestream CO₂ measurement
 about 73
 setting up 73
 Sigh parameter 101, 289
 SIMV ventilation mode 116, 119

- slopeCO2 parameter 180, 295
 - software options, activating on ventilator 270
 - software version, viewing 182
 - specifications
 - accuracy testing 312
 - adjustable alarms 299
 - ASV technical data 304
 - breathing system 306
 - configuration 301
 - control parameters 287
 - dimensions 282
 - disposal 319
 - electrical 285
 - environmental 283
 - essential performance 312
 - functional description of system 312
 - gas monitoring description 314
 - gas supply/delivery description 313
 - monitored parameters 292
 - pneumatic 284
 - pneumatic diagram 315
 - standards/approvals 318
 - symbols used on labels 318
 - technical performance data 307
 - year of disposal 319
 - SpO2 measurement
 - about 74
 - activating option 271
 - data displayed in Dynamic Lung 167
 - enabling 74
 - SpO2/FiO2 parameter 295
 - SPONT ventilation mode 116, 130
 - standards, compliance with 22, 318
 - Standby
 - entering 98
 - entering/exiting 212
 - starting/stopping ventilation 98
 - status indicator panel on front of ventilator, about 48
 - suctioning, performing 214
 - System Info window, viewing device info 182
- T**
- T high parameter 101, 289
 - T low parameter 101, 289
 - TE parameter 176, 294
 - TI max parameter 102, 289
 - TI parameter 102, 176, 289, 294
 - tightness test, performing 82
 - time/date, setting 220
 - time-related parameters 176, 294
 - Tip parameter 102, 290
 - touch screen
 - cleaning agents for 256
 - locking/unlocking 218
 - Tpause parameter (P/V Tool) 290
 - transport, preparing trolley for 55
 - transpulmonary pressure
 - calculating 171
 - setting up 66
 - TRC (tube resistance compensation), about 94
 - TRC-related parameters 102, 290
 - trends
 - about 163
 - displaying 163
 - freezing 161
 - trigger
 - about 91
 - selecting type of 90, 91
 - Trigger parameter 103, 290
 - troubleshooting
 - alarms 189
 - CO2 sensor zero calibration failure 86
 - flow sensor calibration failure 84
 - HAMILTON-H900 humidifier alarms 243
 - IntelliCuff alarms 251
 - O2 sensor calibration 85
 - tightness test failure 83
 - turning the ventilator on/off 66
- V**
- V limit parameter 103
 - V'alv parameter 180, 295
 - VarilIndex parameter 179, 295
 - V'CO2 parameter 180, 295
 - VDaw parameter 180, 295
 - VDaw/VTE parameter 180, 295
 - VeCO2 parameter 181, 295

- Vent Status panel
 - about 168
 - configuring 266
 - displaying 170
 - ventilation
 - alarms, working with 184
 - changing patient data during 210
 - control parameter settings, specifications for 287
 - control parameters, defined 98
 - monitored parameters, list of 172
 - monitoring, overview 154
 - neonatal, setting up for 106
 - preparing for, overview 60
 - settings, changing 211
 - Standby, entering/exiting 212
 - starting/stopping 98
 - ventilation modes
 - ASV, working with 141
 - control settings overview 116
 - control settings, adjusting 90
 - noninvasive ventilation, working with 138
 - overview 114
 - selecting 88
 - ventilation modes, list of 115
 - (S)CMV 118
 - Ambient state 138
 - APRV 129
 - APVcmv 122
 - APVsimv 124
 - ASV 131
 - DuoPAP 128
 - high flow oxygen 137
 - INTELLiVENT-ASV 133
 - nCPAP-PS 136
 - NIV 134
 - NIV-ST 135
 - P-CMV 126
 - P-SIMV 127
 - SIMV 119
 - SPONT 130
 - VS (Volume Support) 120
 - ventilation parameters
 - control settings 98, 287
 - monitored 173, 292
 - ventilation settings
 - entering patient data 78, 106
 - how to adjust 58
 - preconfigured settings (defaults), about 79
 - ventilation timer
 - about 182
 - resetting 182
 - ventilator
 - controls, how to use 58
 - features/options, overview of 40, 41
 - hardware options, overview of 42
 - intended use 20
 - main display, overview of 48
 - mounting options for monitor 56
 - navigating the display 57
 - patient setup, overview 78
 - physical characteristics 43
 - rear view 46
 - turning on/off 66
 - ventilator body, front view 45
 - ventilator monitor
 - front view 44
 - rear view 47
 - ViCO2 parameter 181, 295
 - VLeak parameter 175, 293
 - volume alarms 97, 299
 - Volume Support (VS) ventilation mode 116, 120
 - volume-related parameters 175, 293
 - Vt parameter 104, 290
 - Vt/IBW parameter 103, 176, 293
 - Vt/Wt parameter 103, 176, 293
 - Vtalv parameter 181, 295
 - Vtarget parameter 104, 291
 - VTE NIV parameter 175, 293
 - VTE parameter 175, 293
 - VTESpont parameter 176, 293
 - VTI parameter 176, 293
- ## W
- warranty 320
 - waveforms
 - display options 159
 - displaying 159
 - freezing 161
 - Pressure/time (Paw), about 160
 - types of 157
 - x-axis, changing time scale 161
 - y-axis, changing intervals 161

Weight parameter 104, 291
WOBimp parameter 179, 295

Z

zero calibration
 performing for CO2 sensor/adaptor 85
 Tests & calibs window, accessing 80



More information and free software simulation:
www.hamilton-S1.com



HAMILTON
MEDICAL

Intelligent Ventilation since 1983



Hamilton Medical AG
Via Crusch 8, 7402 Bonaduz, Switzerland
☎ +41 58 610 10 20
✉ info@hamilton-medical.com
www.hamilton-medical.com