



# HAMILTON-T1 Quick Guide



Swiss  
Quality

**HAMILTON**  
**MEDICAL**

Intelligent Ventilation since 1983

This Quick Guide is intended as a useful reference for ventilation of adult and pediatric patients. It does not replace the clinical judgment of a physician or the content of the *HAMILTON-T1 Operator's Manual*, which should always be available when using the HAMILTON-T1 ventilator. Some functions are optional and not available in all markets.

© 2017 Hamilton Medical AG. All rights reserved. Printed in Switzerland.







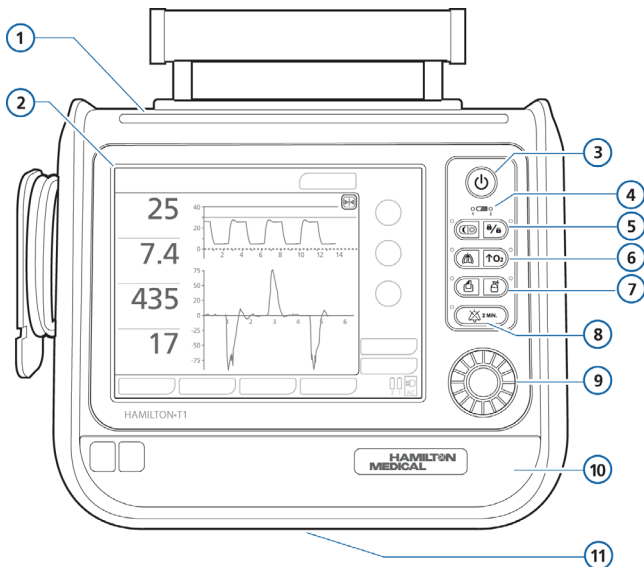

# Table of contents

1. HAMILTON-T1 basics .....	4
2. Setting up the ventilator.....	10
3. Tests and calibrations .....	18
4. Ventilating a patient.....	22
5. Monitoring patient data .....	28
6. Ensuring an adequate oxygen supply for patient transport.....	30
7. Glossary of control parameters .....	32

# 1. HAMILTON-T1 basics

## 1.1 Ventilator front view



- 1 **Alarm lamp.** Red = high-priority alarm, yellow = medium- or low-priority alarm.
- 2 **Touch screen.** Provides access to measurements and controls.
- 3 **Power/Standby key.** Turns the ventilator on and off and accesses standby.
- 4 **Battery charge indicator.** Lit = battery is fully charged. Flashing = battery is charging.
- 5  **Day/Night key.** Switches between the Day and Night display brightness setting.
- 5  **Screen lock/unlock key.** Prevents inadvertent change of settings.
- 6  **Manual breath/inspiratory hold key.** Triggers a mandatory breath when pressed and released during exhalation. Triggers an inspiratory hold when held down during any breath phase. When active, the green indicator is lit.
- 6  **O2 enrichment key.** Delivers 100% oxygen for 2 min. Press the key a second time to cancel. Press **O2** key and disconnect patient to start a suctioning maneuver.
- 7  **Print screen key.** Save a JPG file of the current ventilator screen to a USB memory drive.
- 7  **Nebulizer on/off key.** Activates pneumatic nebulizer for 30 minutes or until pressed again during the inspiration phase if high-pressure oxygen (HPO) is connected.
- 8 **Alarm silence key.** Silences the main ventilator audible alarm for 2 min. Press the key a second time to cancel the alarm silence.
- 9 **Press-and-turn (P&T) knob.** Use to select and adjust ventilator settings.
- 10 **Front cover and battery.** The backup batteries are located inside the front cover.
- 11 **Underside of ventilator.** Expiratory valve bleed port. *Do not obstruct.*

## 1.2 Ventilator side view, with gas connections

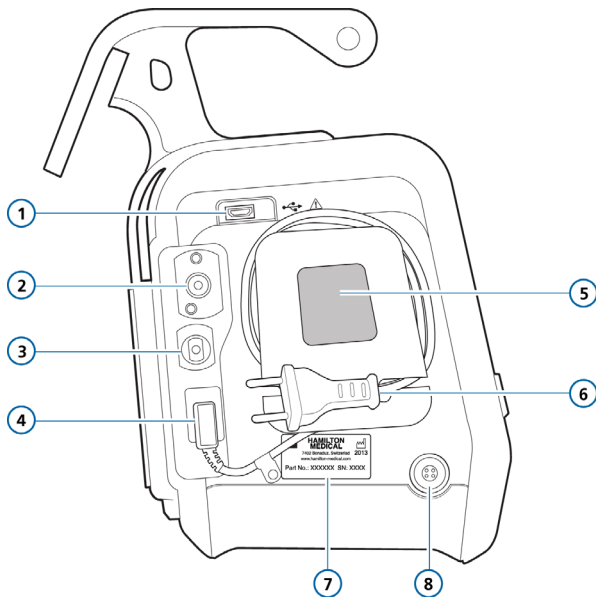



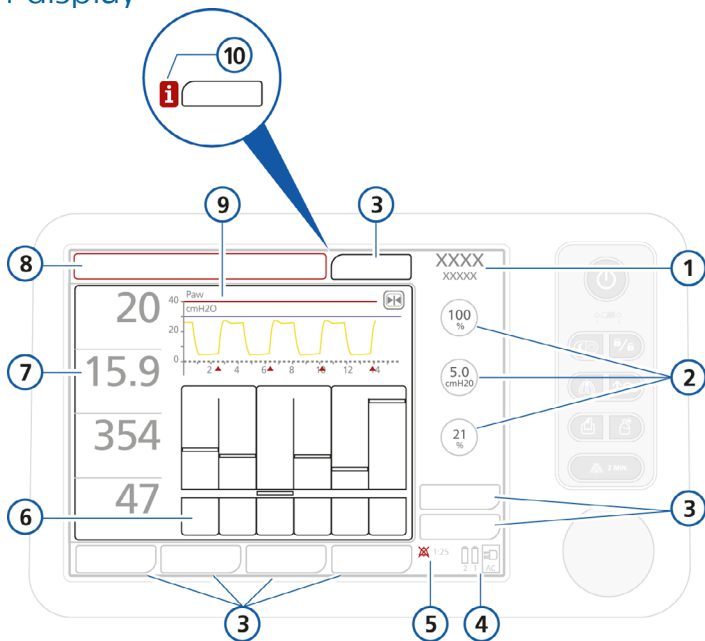

- 1 USB connector
- 2 High-pressure oxygen DISS or NIST inlet fitting
- 3 Low-pressure oxygen connector
- 4 AC power receptacle
- 5 Cooling air intake and dust filter. *Do not obstruct.*
- 6 AC power cord with retaining clip
- 7 Serial number label
- 8 DC power receptacle

## 1.3 Main display





- 1 **Active mode & patient group.**
- 2 **Main controls.** Touch the **Controls** button **(3)** to display all controls for the selected mode.
- 3 **Window tabs.** Open the associated windows.
- 4 **Input power.** Shows available power sources.
- 5 **Alarm silence indicator and countdown.** Shows whether alarm silence has been activated, and displays the remaining silence time.
- 6 **Graphic display.** Shows a user-selectable waveform or an Intelligent Panel graphic (Dynamic Lung, ASV graph, Vent Status).
- 7 **Main monitoring parameters (MMP).** View other numeric parameters from the monitored parameter windows.
- 8 **Message bar.** Displays color-coded alarm messages. If an alarm is active, view the alarm buffer by touching the message bar.
- 9 **Pressure/time waveform.** Always displayed.
  -  The red line is the Pmax high pressure alarm setting.
  -  The blue line is the pressure limit automatically 10 cmH2O below the Pmax alarm setting.
  -  The pink triangles indicate the patient is triggering a breath.
  -  The **Freeze** button freezes the graphic for up to 30 s.
- 10 **Alarm indicator (i-icon).** Touch the icon to view information about alarms.

## 2. Setting up the ventilator

### 2.1 Installing the expiratory valve

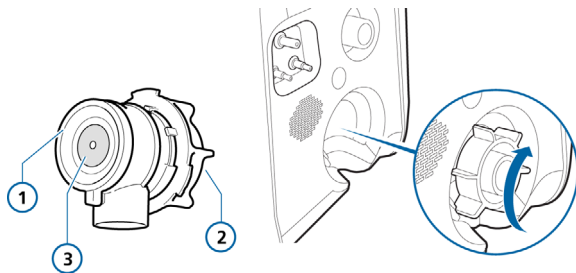

- 1 Expiratory valve membrane
- 2 Expiratory valve housing
- 3 Metal plate facing the ventilator

#### Installing the expiratory valve

- 1 Holding the expiratory valve housing, seat the silicone membrane onto the housing. The metal plate must face up and be visible.
- 2 Position the housing and twist clockwise until it locks into place.

Single use and autoclavable expiratory valves are available.

## 2.2 Connecting a coaxial breathing circuit

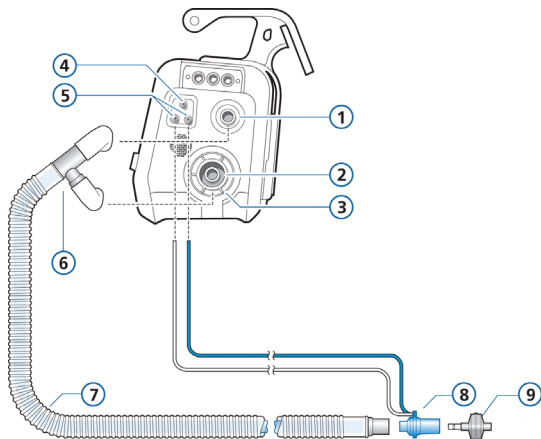

- 1 To patient (inspiratory port)
- 2 From patient (expiratory port)
- 3 Adult/pediatric expiratory valve set
- 4 Nebulizer outlet
- 5 Flow sensor connectors
- 6 Limb connector
- 7 Coaxial inspiratory/expiratory limb
- 8 Flow sensor
- 9 HMEF

Connect the breathing circuit to the inspiratory and expiratory ports (**1, 2**) and the flow sensor tubes to the flow sensor connectors (**5**).

Use either a bacteria filter or a combined heat-moisture exchanger and filter (HMEF).

## 2.3 Connecting a dual limb circuit

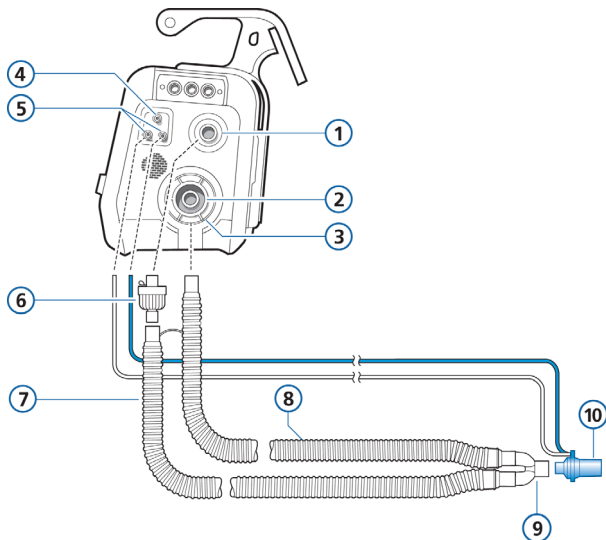

- 1 To patient (inspiratory port)
- 2 From patient (expiratory port)
- 3 Adult/pediatric expiratory valve set
- 4 Nebulizer outlet
- 5 Flow sensor connectors
- 6 Bacteria filter
- 7 Inspiratory limb
- 8 Expiratory limb
- 9 Y-piece (integrated with breathing circuit)
- 10 Flow sensor

Use either a bacteria filter or a combined heat-moisture exchanger and filter (HMEF).

## 2.4 Connecting an adult/pediatric flow sensor

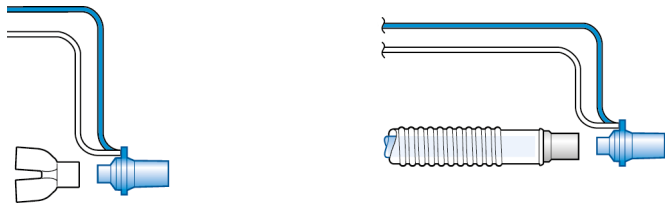

## 2.5 Connecting the internal pneumatic nebulizer

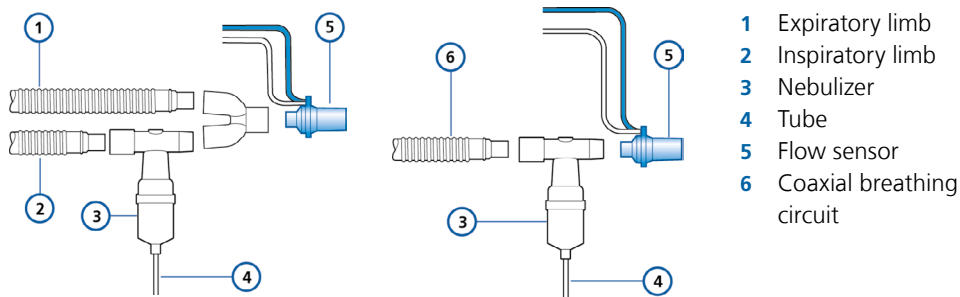

## 2.6 Connecting a CO2 mainstream sensor

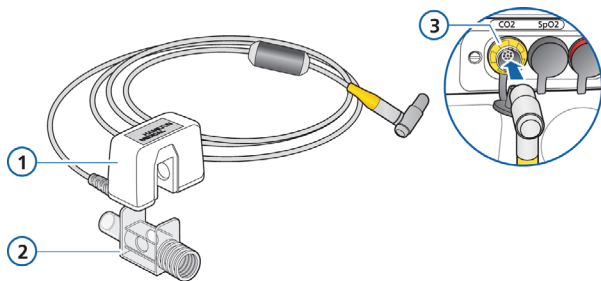

### Attaching the CO2 sensor to the airway adapter

- 1 CO2 sensor
- 2 Airway adapter
- 3 Connect to CO2 port on ventilator

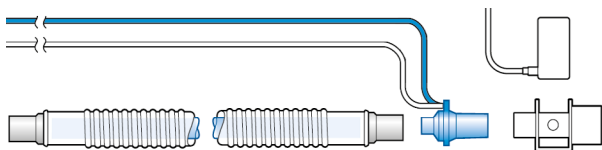

### Connecting the CO2 sensor/ adapter to the patient circuit

You can connect the CO2 sensor before or after the flow sensor according to your institution's protocol.

## 2.7 Connecting a CO2 sidestream sensor

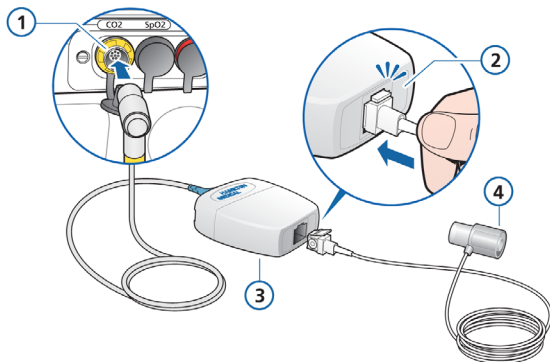

### Inserting the sample cell into the CO2 module

- 1 Connect to CO2 port on ventilator
- 2 Sample cell clicks into place
- 3 LoFlow sidestream CO2 module
- 4 Airway adapter

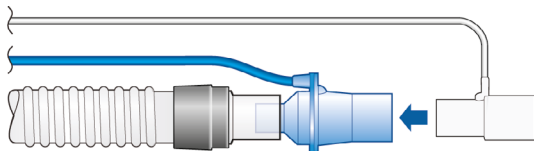

### Attaching the CO2 sensor to the airway

## 2.8 Connecting an SpO2 monitor

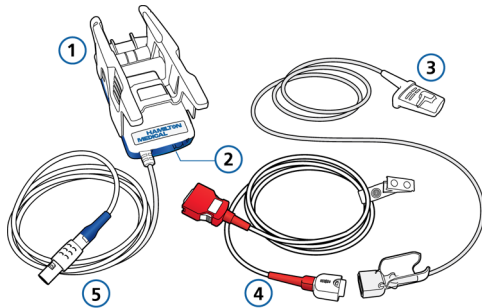

### Masimo SET pulse oximeter components

- 1 Adapter, which contains the oximeter hardware
- 2 Cable connection ports
- 3 Sensor and cable
- 4 Patient cable (connects to adapter and sensor)
- 5 Adapter cable (connects the adapter to SpO2 connector on ventilator)

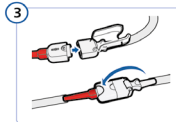
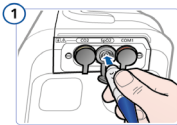

### Connecting the cables

- ▶ Connect the ventilator, patient, and sensor cables as shown.

Not all options are available in all markets.



## 2.9 Enabling CO2/SpO2 monitoring

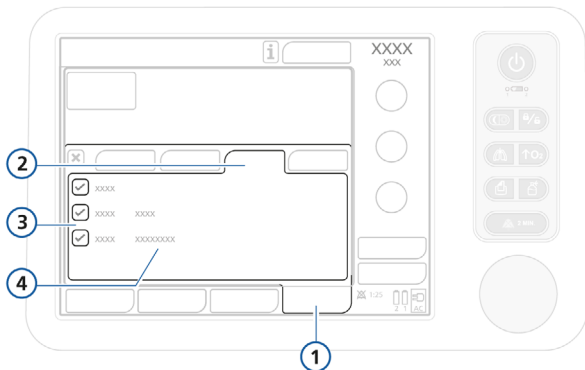

- 1 System
- 2 Sensors on/off
- 3 CO2 and SpO2
- 4 Sensor status

### To enable CO2 / SpO2 monitoring

- 1 Open the System > Sensors on/off window.
- 2 Select the CO2 and/or SpO2 checkboxes, and close the window.

The status text **Active** appears next to the checkbox as long as the adapter is connected to the ventilator. If the status area is empty, the adapter is not connected.

## 3. Tests and calibrations

### 3.1 Performing the preoperational checks

- 1 Connect ventilator to AC or DC power and an oxygen supply.
- 2 Assemble the patient breathing circuit.
- 3 Turn on power.

The ventilator runs a self-test and displays the Standby window. Use only if ventilator passes all tests.

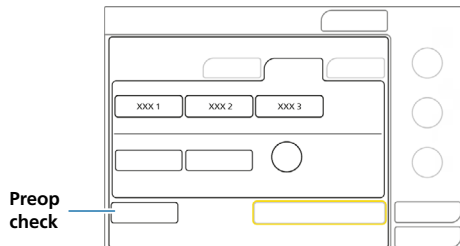

#### Step one

- 1 Touch **Preop check** in the Standby window. The System > Tests & calib window is displayed.
- 2 Touch the **Tightness** button to perform the tightness test.

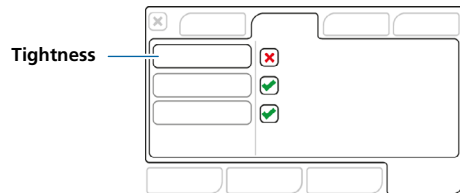

- 4 When prompted, block the patient end of the breathing circuit. Hold until prompted.

Pass ✓ or fail ✗ and date/time of completed test are displayed.

### Step two

- 1 Touch the **Flow Sensor** button to calibrate the flow sensor.
- 2 When prompted, turn the flow sensor and connect to Y-piece using the calibration adapter. Calibration starts automatically.
- 3 When prompted, turn the flow sensor again and remove the calibration adapter. Calibration starts automatically.

Pass ✓ or fail ✗ and date/time of completed test are displayed.

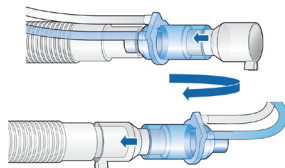
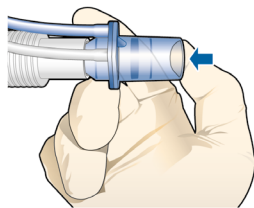

### Step three

- 1 If necessary, and if prompted by **✗** next to the **O2 test** button, perform the O2 sensor calibration.
- 2 Touch the **O2 test** button.  
If **O2 cell calibration needed** alarm is active, repeat O2 calibration once device has warmed up (after 30 minutes).

### Step four

To demonstrate the alarm's operation, perform an alarm test.

#### Loss of external power test

- 1 Ensure the ventilator is connected to AC power.
- 2 Disconnect the power cord.
- 3 Verify that the **Loss of external power** alarm is generated and that the ventilator is powered by its backup battery.
- 4 Reconnect the ventilator to AC power.
- 5 Verify that the alarm resets and that the ventilator is again powered by AC.

The HAMILTON-T1 is ready to ventilate **✓**.

## 3.2 If the preoperational check fails

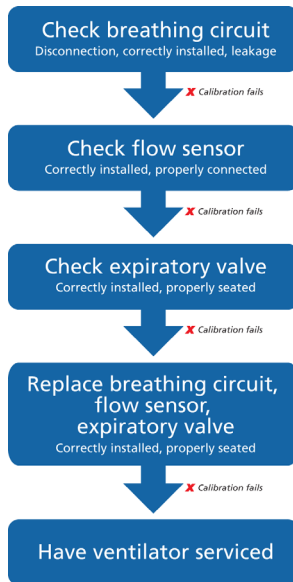

## 4. Ventilating a patient

### 4.1 Using Quick Setup

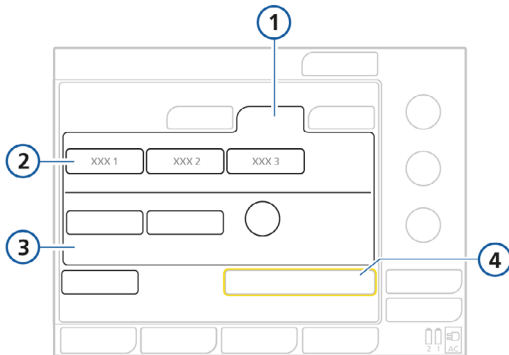

- 1 Patient group
- 2 Quick Setup buttons
- 3 Gender and patient height
- 4 Start ventilation

A *Quick setup* refers to a group of settings you define, including patient characteristics (group and weight), mode selection and some control settings, alarm limit settings, and weaning zone limits, that is automatically applied when the setup is selected in the Standby window.

The HAMILTON-T1 has three configurable Quick Setup buttons.

Settings can be configured in advance according to your institution's standard protocols.

Once configured, you can start ventilation in six easy steps.

- 1 Touch one of the three Quick Setup buttons.
- 2 Touch **Male** or **Female**.
- 3 Touch **Pat. Height** and adjust patient height using the Press-and-Turn knob.  
The ventilator uses patient height and gender to calculate the ideal body weight (IBW). IBW is used to determine several startup settings (see page25).
- 4 If required, touch **Modes** tab to change ventilation mode.
- 5 Review control and alarm settings.
- 6 Touch **Start ventilation**.

## 4.2 Selecting modes

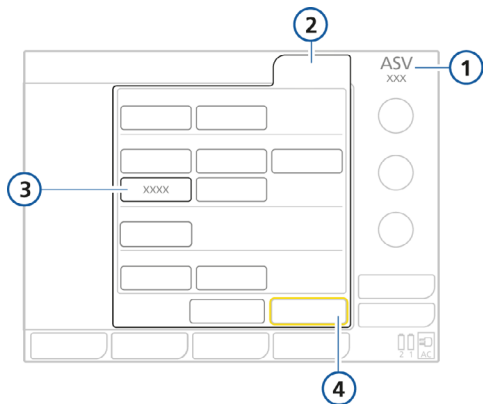

- 1 Active mode
- 2 Modes
- 3 New mode to apply
- 4 Confirm

### To change the mode

- 1 Select the desired ventilation mode.
- 2 Touch **Confirm**.  
The Controls window opens.



## 4.3 Adjusting controls

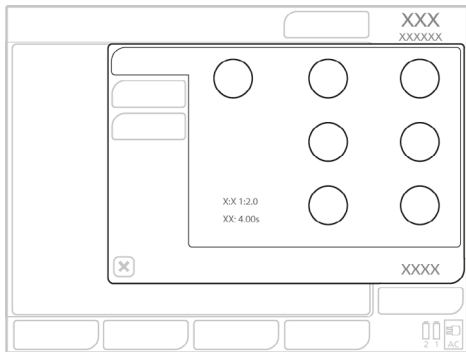

### To adjust controls

- 1 Touch the control to adjust.  
The control button turns orange.
- 2 Use the P&T knob to change to the desired setting.
- 3 Confirm changes to the setting by touching the control again or by pressing the P&T knob.  
The control button turns blue.  
Confirm changes before modifying another control.

The following parameters are set based on ideal body weight (IBW): Vt, Rate, Thigh, Tlow, TI, ExpMinVol, and Vt alarm limits. The ventilator uses the Vt/IBW setting to set the initial delivered Vt in volume-controlled modes.

See glossary of control parameters on page 32.

## 4.4 Adjusting alarm limits

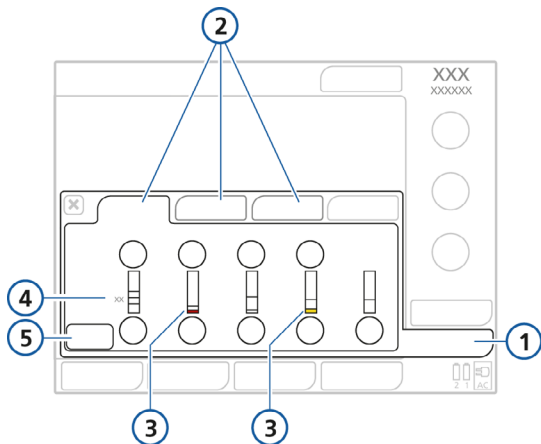

- 1 Alarms
- 2 Limits 1, 2, 3
- 3 Red or yellow bar (depending on alarm priority) indicates the monitored value is out of range
- 4 Current monitored value
- 5 **Auto** button

Changing the High pressure and VT high alarm settings may affect ventilation. See next page.

## High pressure alarm

The High pressure alarm sets the pressure limit 10 cmH<sub>2</sub>O below the P<sub>max</sub> setting. Changing the Pressure alarm limit also changes the maximum pressure applied by the ventilator.

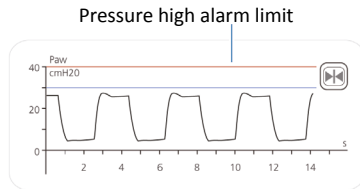
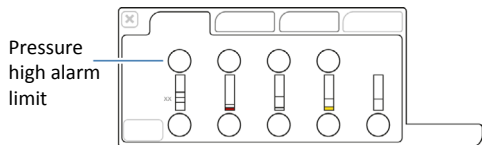

## VT high alarm

Inspiratory volume is limited to 1.5 times the set VT high alarm limit. Changing the VT high alarm may limit the inspiratory volume. Volume limitation is disabled in NIV modes.

## 5. Monitoring patient data

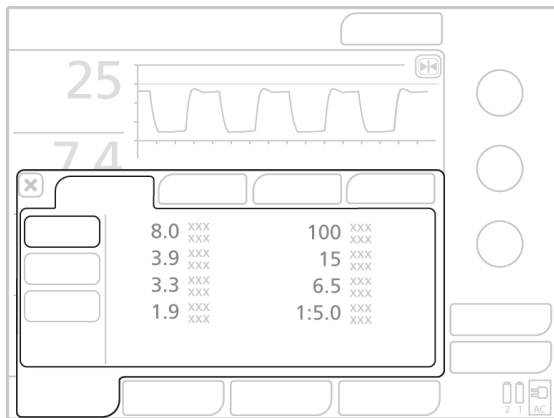

- ▶ Touch the **Monitoring** button to access patient data.

# 5.1 Monitoring patient data using the dynamic lung

The dynamic lung shows compliance ( $C_{stat}$ ) and resistance ( $R_{insp}$ ) breath-by-breath relative to "normal" values for the patient's height.

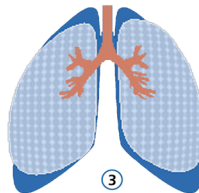
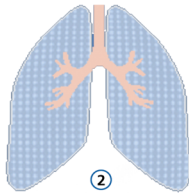
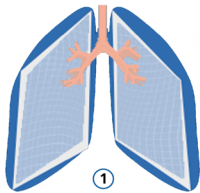

- 1 Low compliance
- 2 Normal compliance
- 3 High compliance

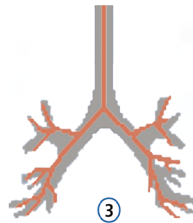
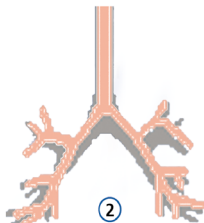
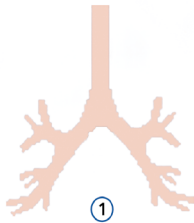

- 1 Normal resistance
- 2 Moderately high resistance
- 3 High resistance

## 6. Ensuring an adequate oxygen supply for patient transport

Before transporting a patient, ensure an adequate oxygen supply by checking the **O2** consumption parameter. During ventilation the current oxygen consumption rate is displayed in the **O2** consumption parameter (l/min) in the System > Info window.

The oxygen consumption of a nebulizer attached to the device is not included in the **O2** consumption parameter value.

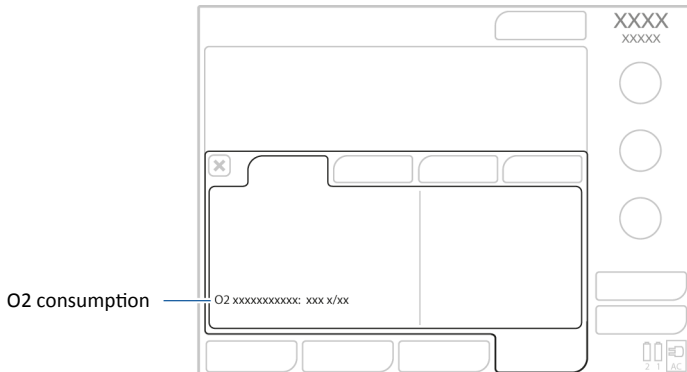

## 6.1 Estimating O2 consumption for transport

Prior to transport you can estimate the patient's O2 consumption.

For smaller patients,  $\leq 70$  cm, IBW  $\leq 8$  kg

$$\text{O2 consumption} = [(\text{ExpMinVol} * 2) + 3 \text{ l/min}] * (\text{FiO2} - 20.9) / 79.1$$

For larger patients,  $> 70$  cm, IBW  $> 8$  kg

$$\text{O2 consumption} = (\text{ExpMinVol} + 3 \text{ l/min}) * (\text{FiO2} - 20.9) / 79.1$$

Additional amount for the nebulizer oxygen use

$$\text{Nebulizer O2 consumption} = 8 \text{ l/min} * \text{Insp time/total breath time}$$

## 7. Glossary of control parameters

Parameter	Definition
Apnea Backup	A function that provides ventilation after the adjustable apnea time passes without breath attempts. If “Automatic” is enabled, control parameters are calculated based on the patient’s IBW.
ETS	Expiratory trigger sensitivity. The percentage of peak inspiratory flow at which the ventilator cycles from inspiration to exhalation.
Flow trigger	The patient’s inspiratory flow that triggers the ventilator to deliver a breath.
Gender	Sex of patient. Used to compute ideal body weight (IBW) for adults and pediatrics.
I:E	Ratio of inspiratory time to expiratory time. Applies to mandatory breaths.
%MinVol	Percentage of minute volume to be delivered in ASV mode. The ventilator uses the %MinVol, Pat. height, and Gender settings to calculate the target minute ventilation.
Oxygen	Oxygen concentration to be delivered.
Pasvlimit	The maximum pressure to apply in ASV mode. Changing Pasvlimit or the Pressure alarm limit automatically changes the other: The Pressure alarm limit is always 10 cmH <sub>2</sub> O greater than Pasvlimit.
Pat. height	Patient height. It determines the ideal body weight (IBW), which is used in calculations for ASV and startup settings for adult and pediatric patients.



# Glossary of control parameters

Parameter	Definition
Pcontrol	The pressure additional to PEEP/CPAP.
PEEP/CPAP	Positive end expiratory pressure.
P high	The high pressure setting in APRV and DuoPAP modes. Absolute pressure, including PEEP.
Pinsp	Pressure (additional to PEEP/CPAP) to apply during the inspiratory phase. Applies in PSIMV+ IntelliSync and NIV-ST.
P low	The low pressure setting in APRV.
P-ramp	Pressure ramp. Time required for inspiratory pressure to rise to the set (target) pressure.
Psupport	Pressure support for spontaneous breaths in SPONT, NIV, and SIMV+ modes.
Rate	Respiratory frequency or number of breaths per minute.
Sigh	Breaths delivered at a regular interval (every 50 breaths) at a pressure up to 10 cmH <sub>2</sub> O higher than non-sigh breaths, as allowed by the Pressure alarm limit.

# Glossary of control parameters

## Parameter

## Definition

---

Thigh	Length of time at the higher pressure level, <b>P high</b> , in DuoPAP and APRV modes.
TI	Inspiratory time, the time to deliver the required gas (time to reach the operator-set Vt or Pcontrol value). Used with <b>Rate</b> to set the breath cycle time.
TI max	Maximum inspiratory time for flow-cycled breaths in NIV, NIV-ST, and SPONT in neonatal modes.
T low	Length of time at the lower pressure level, <b>P low</b> , in APRV mode.
Vt	Tidal volume delivered during inspiration in (S)CMV+ and SIMV+ modes.
VT/kg	Tidal volume per weight.



PN 624840/01

**Manufacturer:**

Hamilton Medical AG

Via Crusch 8, 7402 Bonaduz, Switzerland

☎ +41 58 610 10 20

info@hamilton-medical.com

[www.hamilton-medical.com](http://www.hamilton-medical.com)

**HAMILTON**  
**MEDICAL**

Intelligent Ventilation since 1983